



US00D479895S

(12) **United States Design Patent**
Lai

(10) **Patent No.:** **US D479,895 S**

(45) **Date of Patent:** **** Sep. 23, 2003**

(54) **COSMETIC CASING**

(75) Inventor: **Chin Chun Lai**, Hsin Chuang (TW)

(73) Assignee: **Chad Ling Chemical Industry Co., LTD**, Taipei (TW)

(**) Term: **14 Years**

(21) Appl. No.: **29/175,261**

(22) Filed: **Jan. 27, 2003**

(51) **LOC (7) Cl.** **28-03**

(52) **U.S. Cl.** **D28/83**

(58) **Field of Search** D28/73, 76, 78-84;
D3/295; 206/581, 823, 1.8; 132/293-307,
314-315; 220/DIG. 26; D9/341

(56) **References Cited**

U.S. PATENT DOCUMENTS

- D279,688 S * 7/1985 Kitai et al. D28/83
- D281,915 S * 12/1985 Sussman D28/83
- D471,322 S * 3/2003 Lai D28/83

OTHER PUBLICATIONS

Item M300, Hong Kong Enterprises, p. 760, 10-94.*

* cited by examiner

Primary Examiner—Jennifer Rivard

(57) **CLAIM**

The ornamental design for a cosmetic casing, as shown and described.

DESCRIPTION

FIG. 1 is a perspective view of a cosmetic casing showing my new design;
 FIG. 2 is a front elevational view thereof;
 FIG. 3 is a rear elevational view thereof;
 FIG. 4 is a top plan view thereof;
 FIG. 5 is a bottom plan view thereof;
 FIG. 6 is a left side elevational view thereof; and,
 FIG. 7 is a right side elevational view thereof.

1 Claim, 6 Drawing Sheets

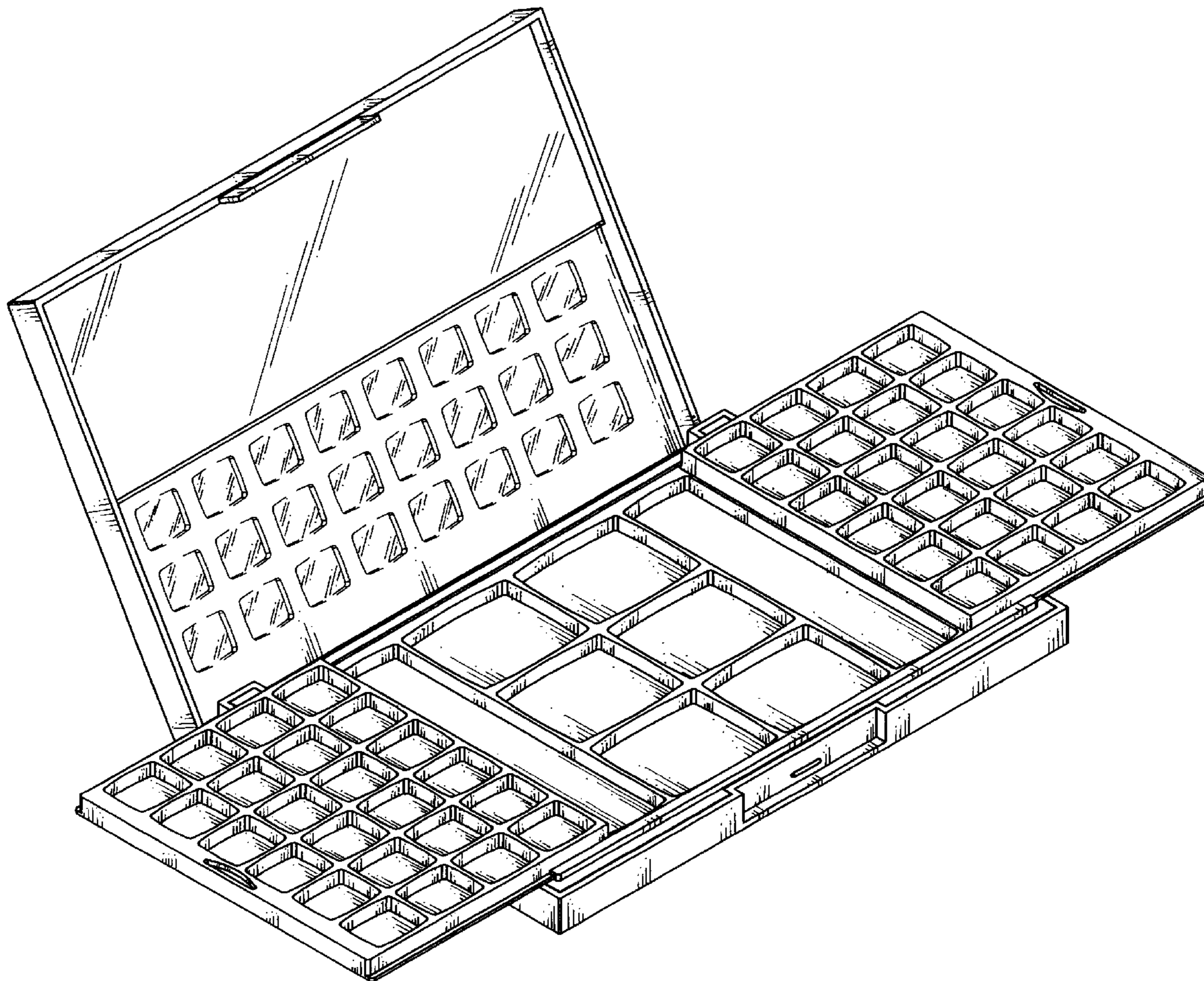

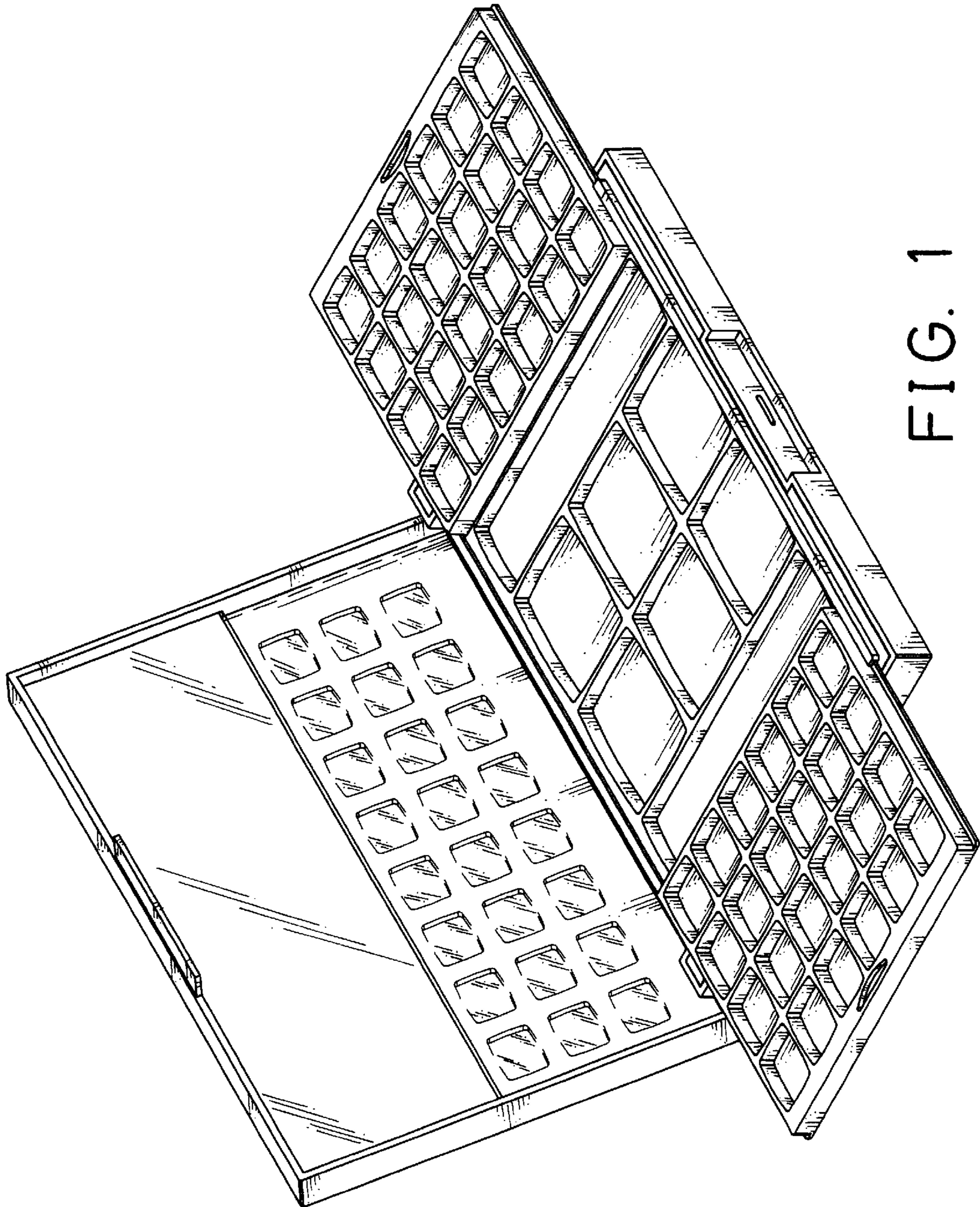

FIG. 1

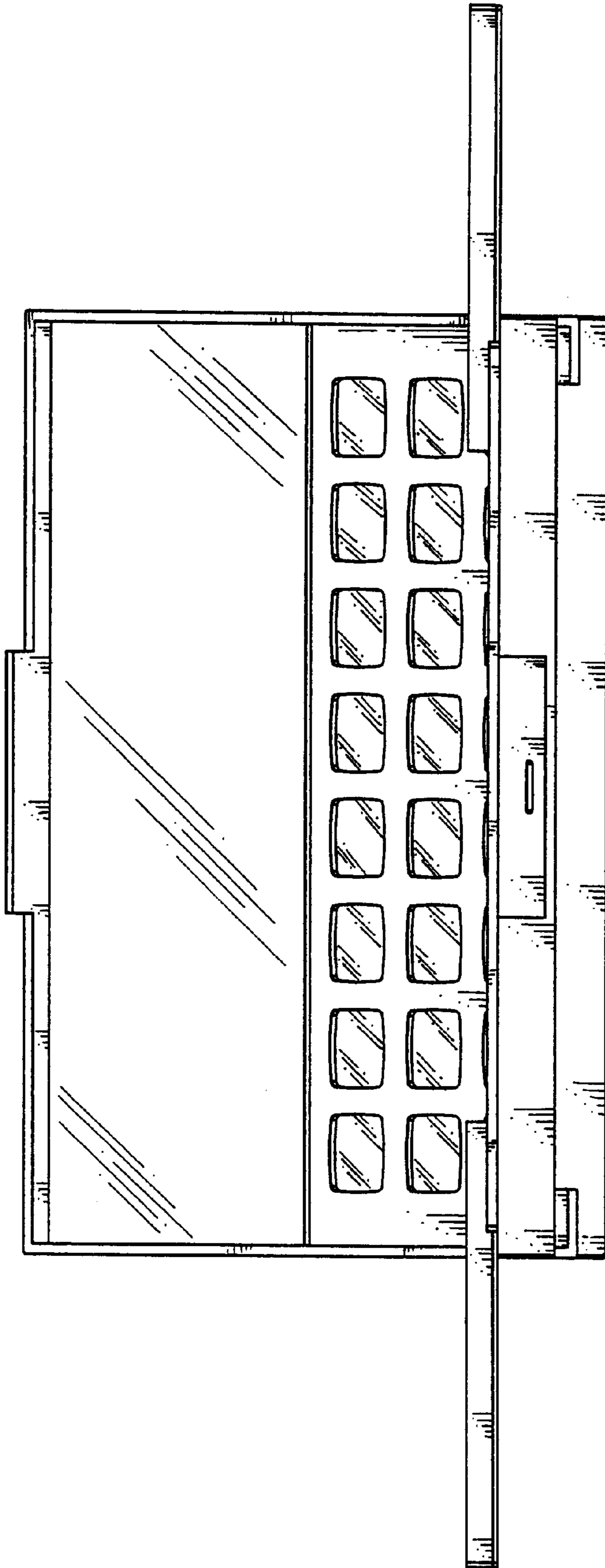

FIG. 2

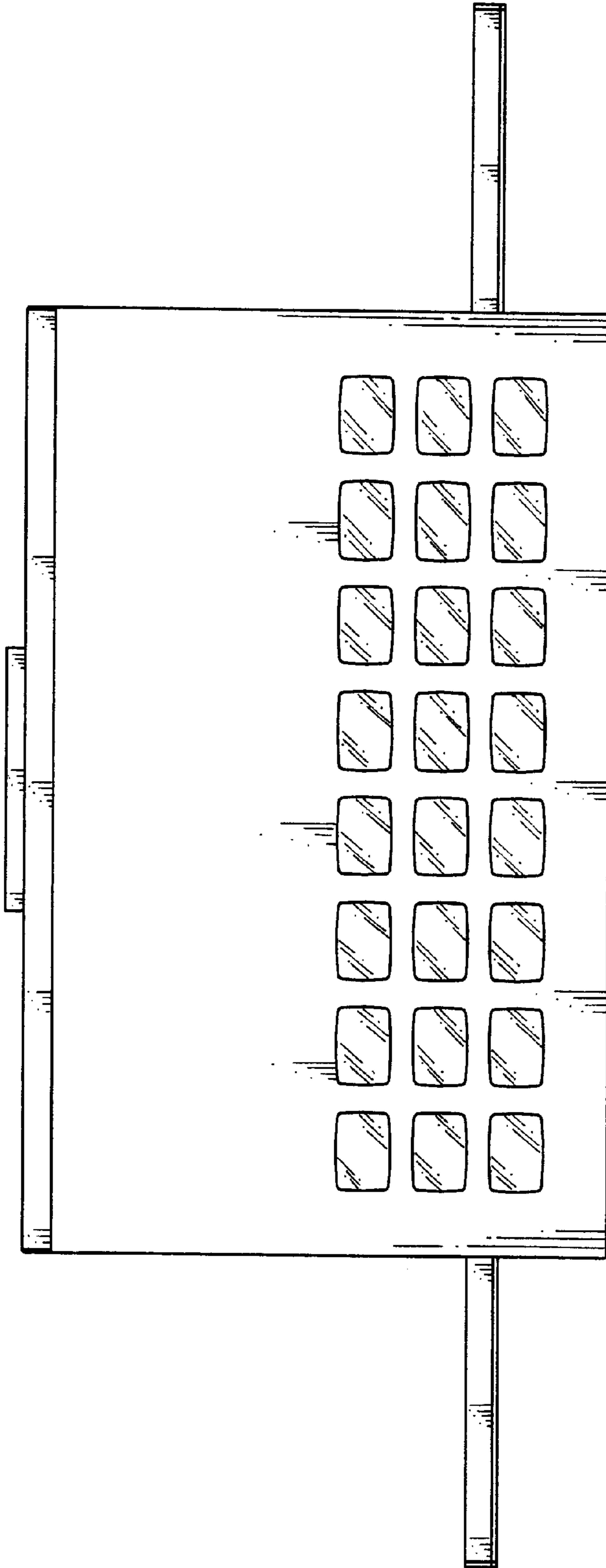

FIG. 3

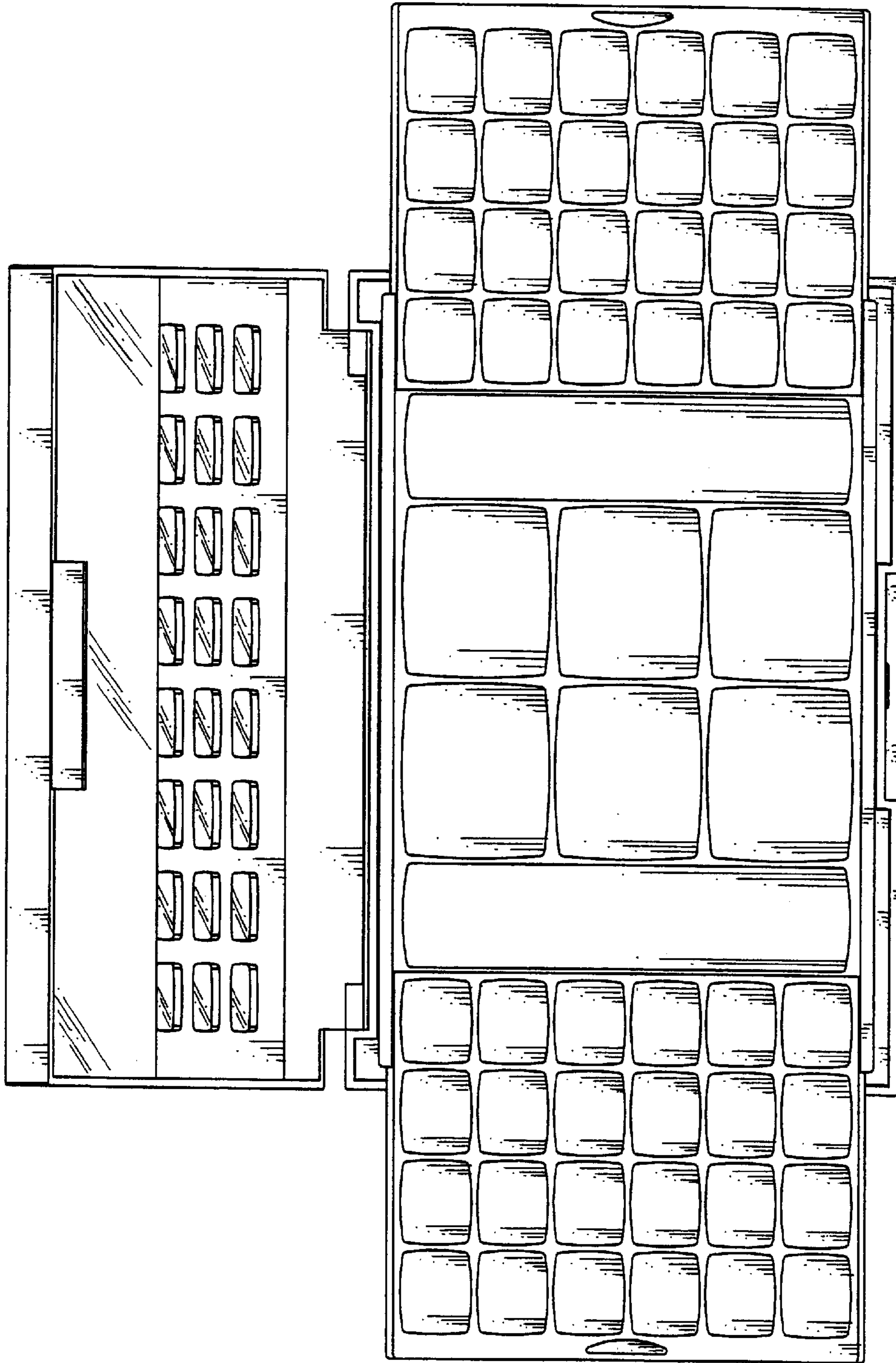

FIG. 4

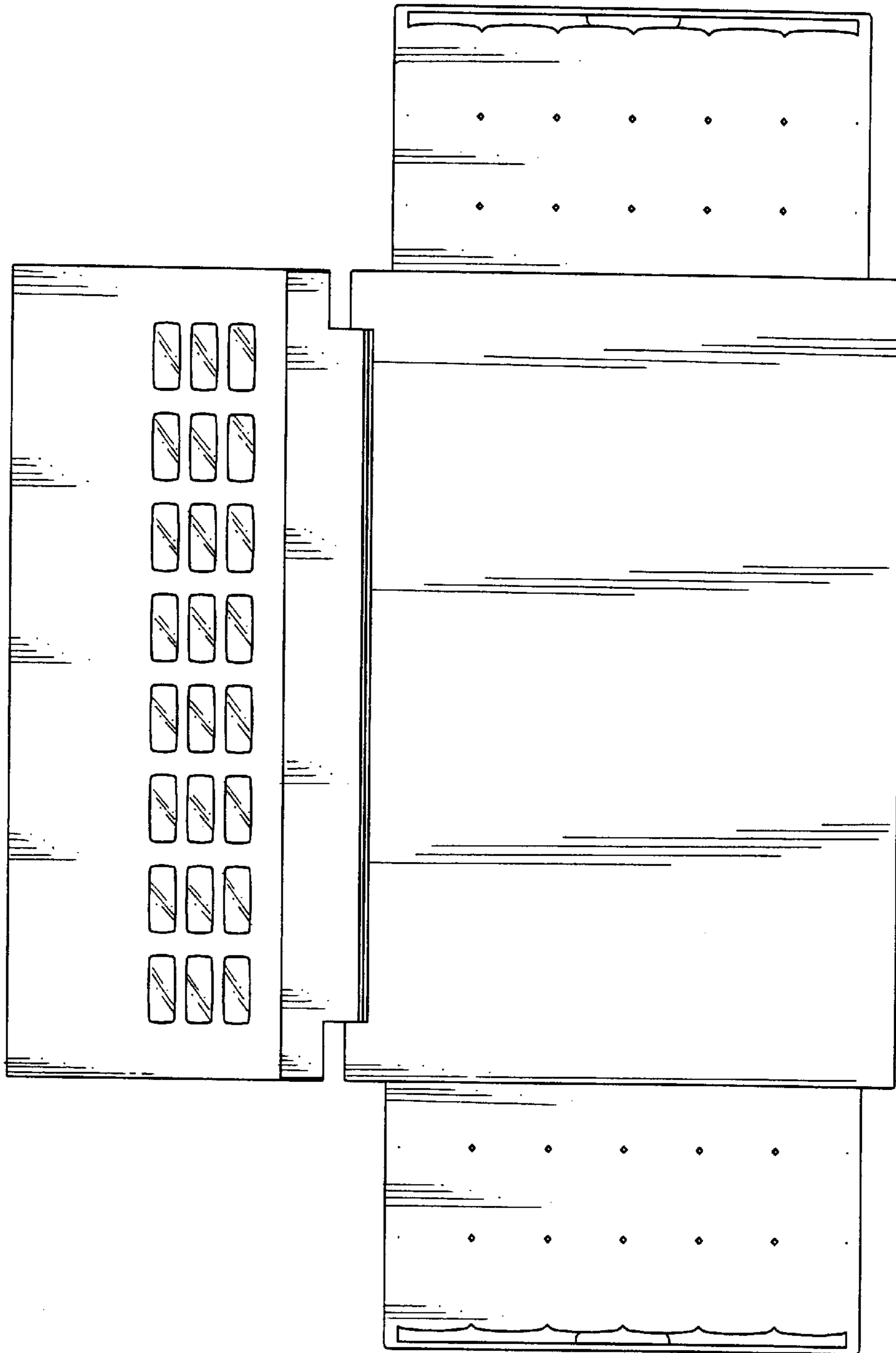

FIG. 5

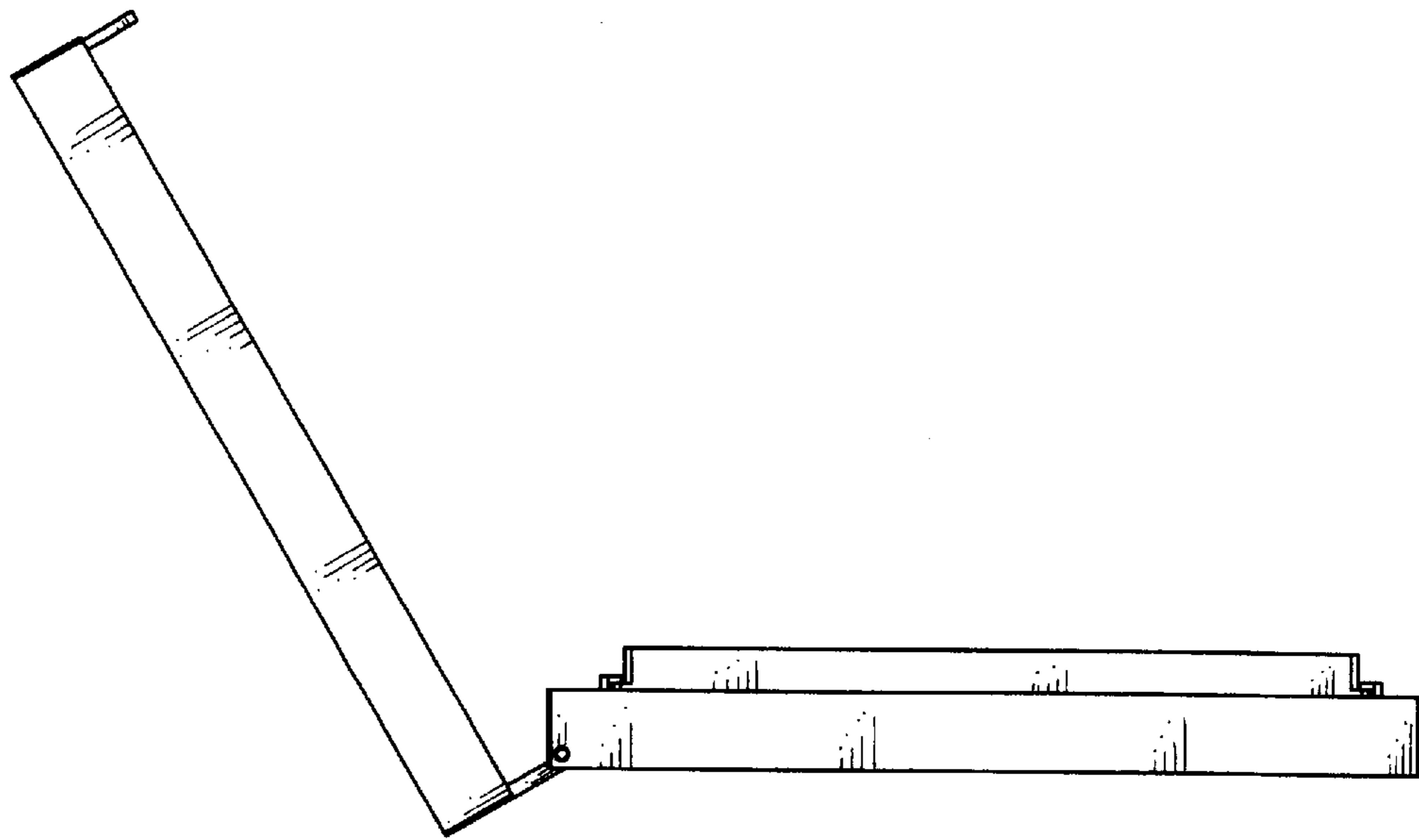

FIG. 6

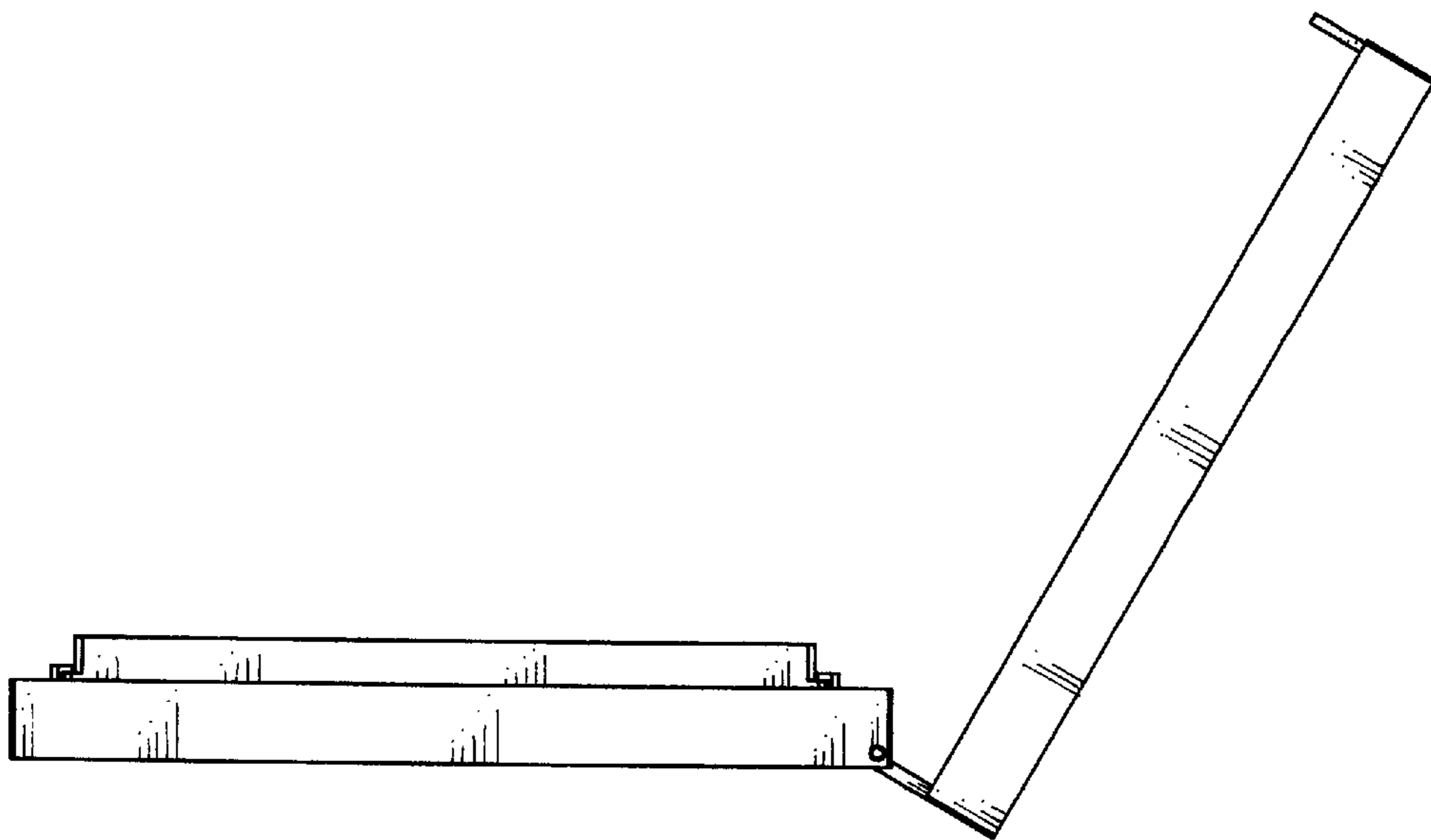

FIG. 7