



US00D479852S

(12) **United States Design Patent**
Odman

(10) **Patent No.:** **US D479,852 S**

(45) **Date of Patent:** **** Sep. 23, 2003**

(54) **BEARING COVER AND SUPPORT FOR PAPER TRIMMER**

(75) Inventor: **Shanon T. Odman**, Wabash, IN (US)

(73) Assignee: **SOP Services, Inc.**, Las Vegas, NV (US)

(**) Term: **14 Years**

(21) Appl. No.: **29/146,982**

(22) Filed: **Aug. 20, 2001**

(51) **LOC (7) Cl.** **18-04**

(52) **U.S. Cl.** **D18/34**

(58) **Field of Search** D18/34, 99; D19/72, D19/65; D15/127, 129, 141, 199; 83/607, 608, 609, 636, 613, 635, 13, 25, DIG. 1, 701, 467.1, 468, 585, 167; 30/262; D8/83, 107

(56) **References Cited**

U.S. PATENT DOCUMENTS

D228,825 S * 10/1973 Pottorn D18/34
D319,255 S * 8/1991 Beno et al. D18/34

D321,715 S * 11/1991 Beno et al. D18/34
D377,368 S * 1/1997 Rellinger D18/34
D409,651 S * 5/1999 Rellinger D18/34
D443,294 S * 6/2001 Munoz D18/34

* cited by examiner

Primary Examiner—Martie K. Holtje

(74) *Attorney, Agent, or Firm*—Cardinal Law Group

(57) **CLAIM**

The ornamental design for a bearing cover and support for paper trimmer, as shown and described.

DESCRIPTION

FIG. 1 is a perspective view of the bearing cover & support for paper trimmer;
FIG. 2 is a front view;
FIG. 3 is a top view;
FIG. 4 is a left end view;
FIG. 5 is a bottom view; and,
FIG. 6 is a right end view thereof.
The broken lines in the figures showing portions of the paper trimmer in FIGS. 1–6 are for illustrative purposes only and form no part of the claimed design.

1 Claim, 6 Drawing Sheets

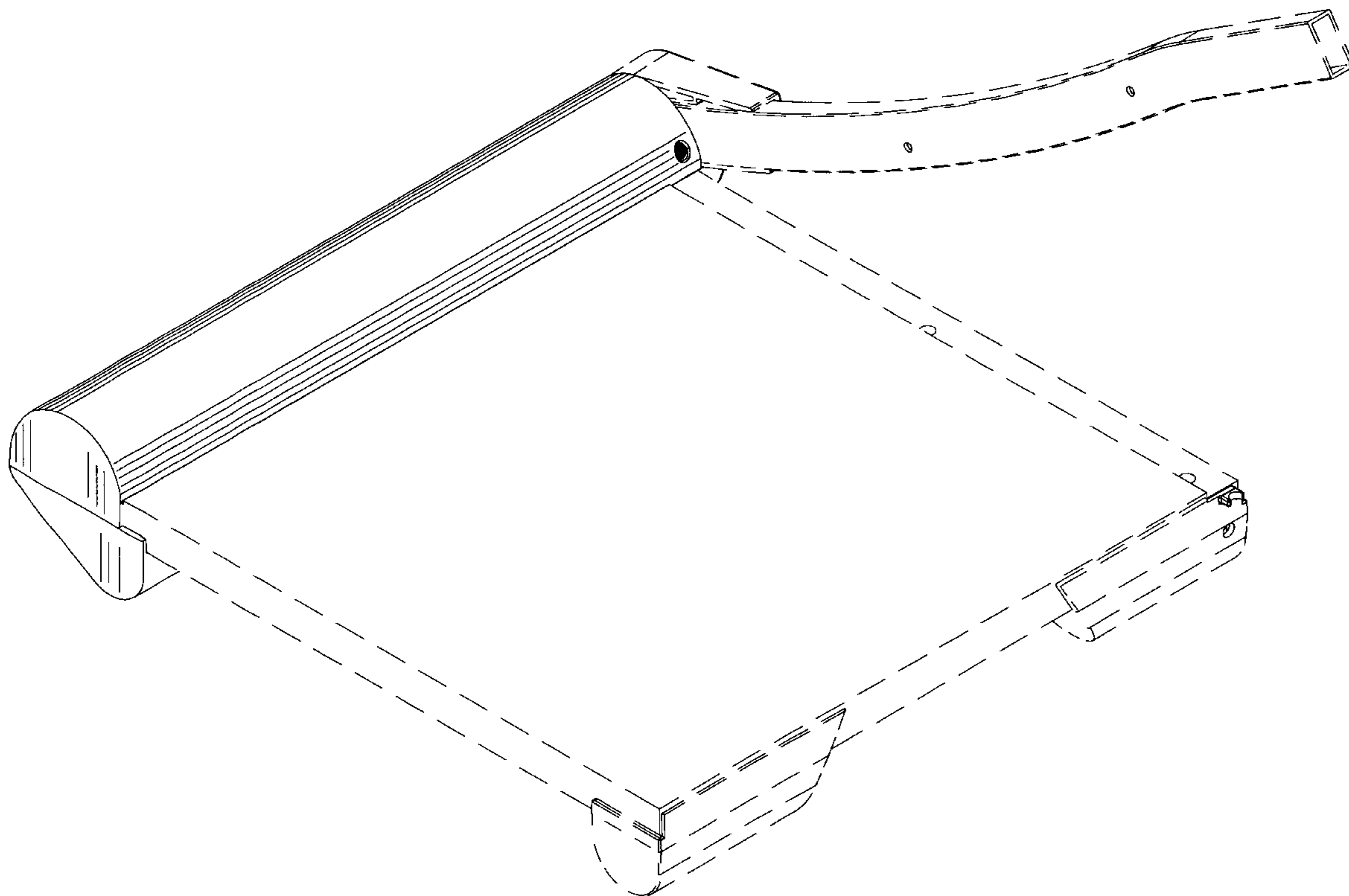

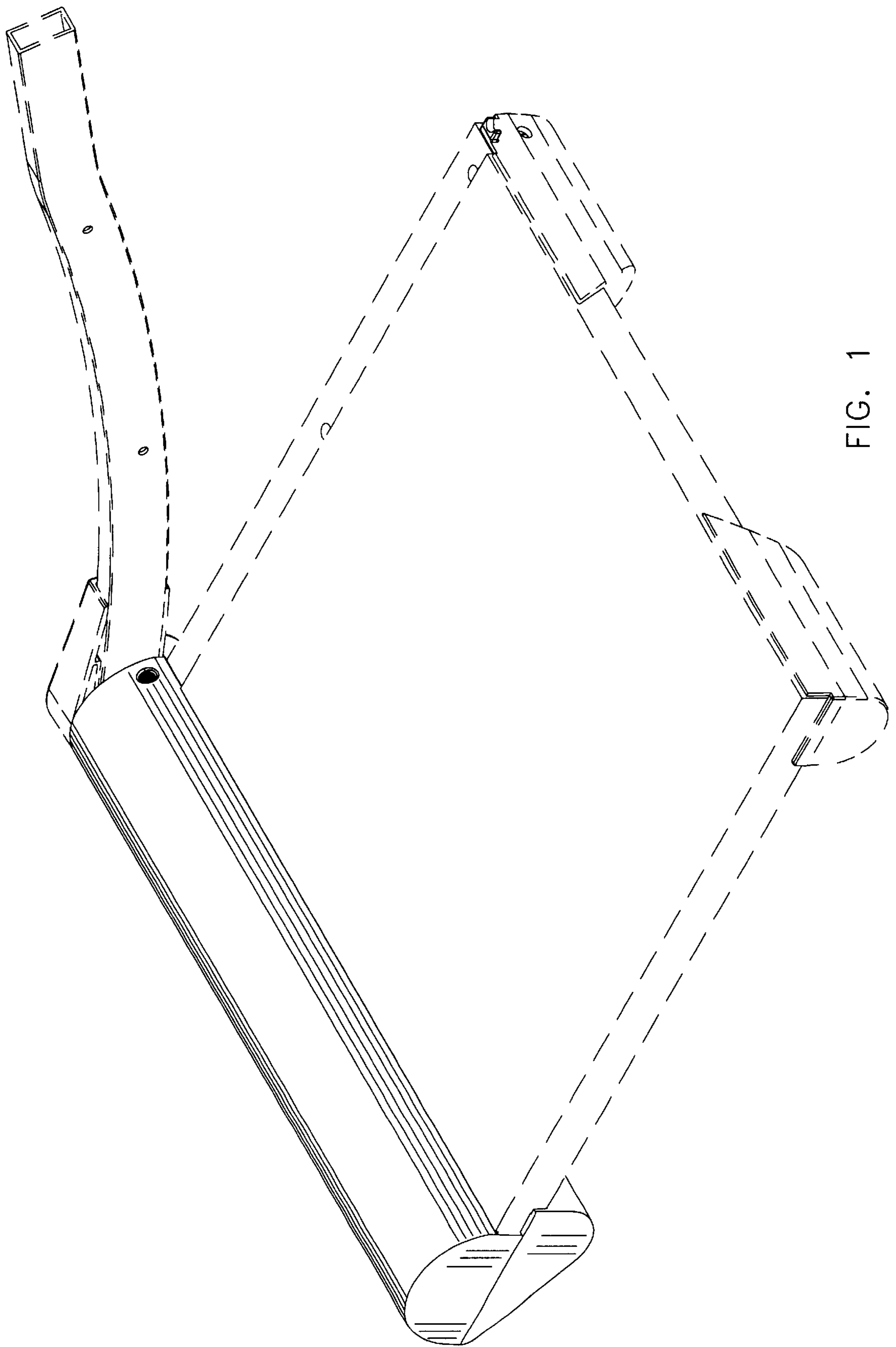

FIG. 1

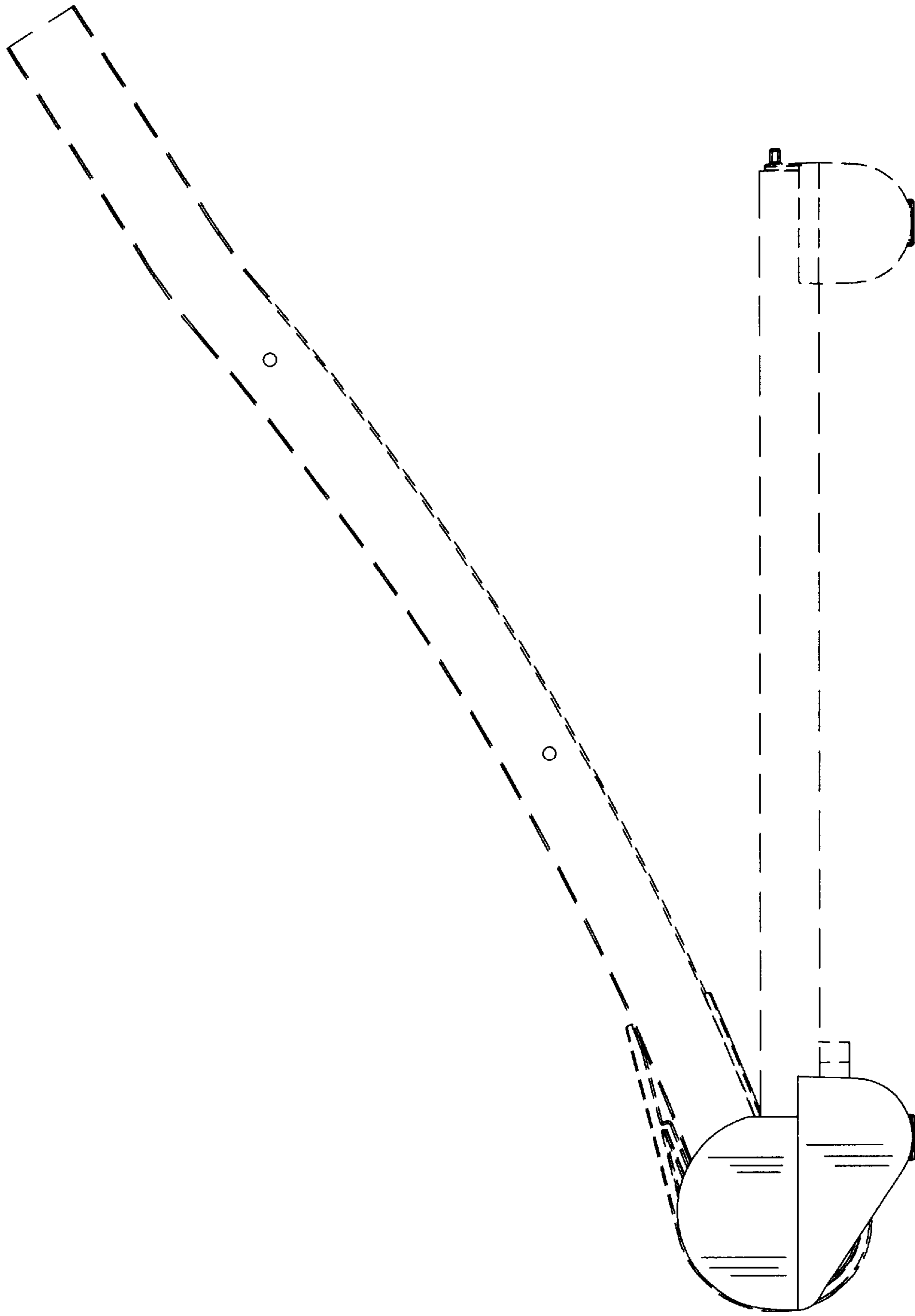

FIG. 2

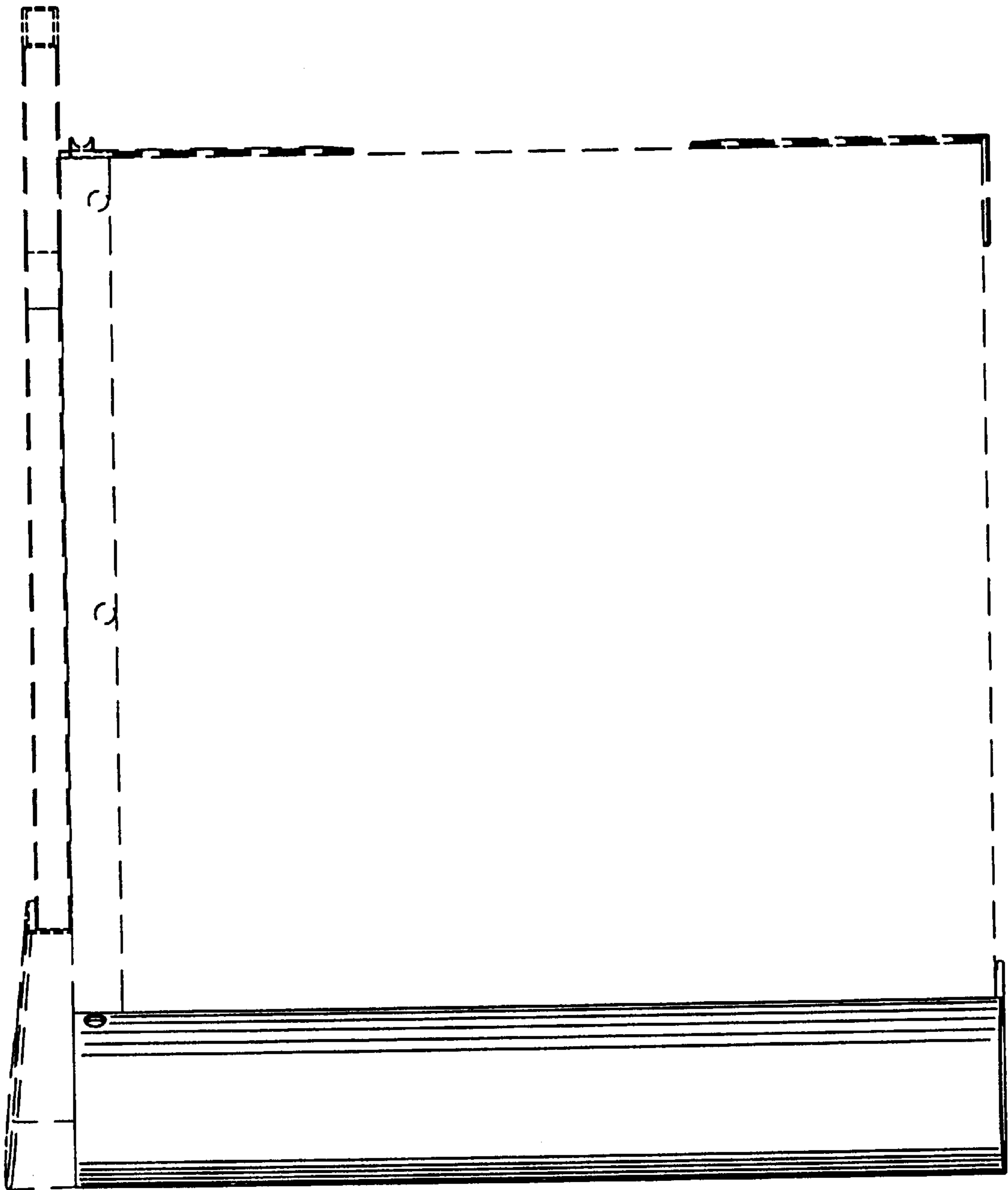

FIG. 3

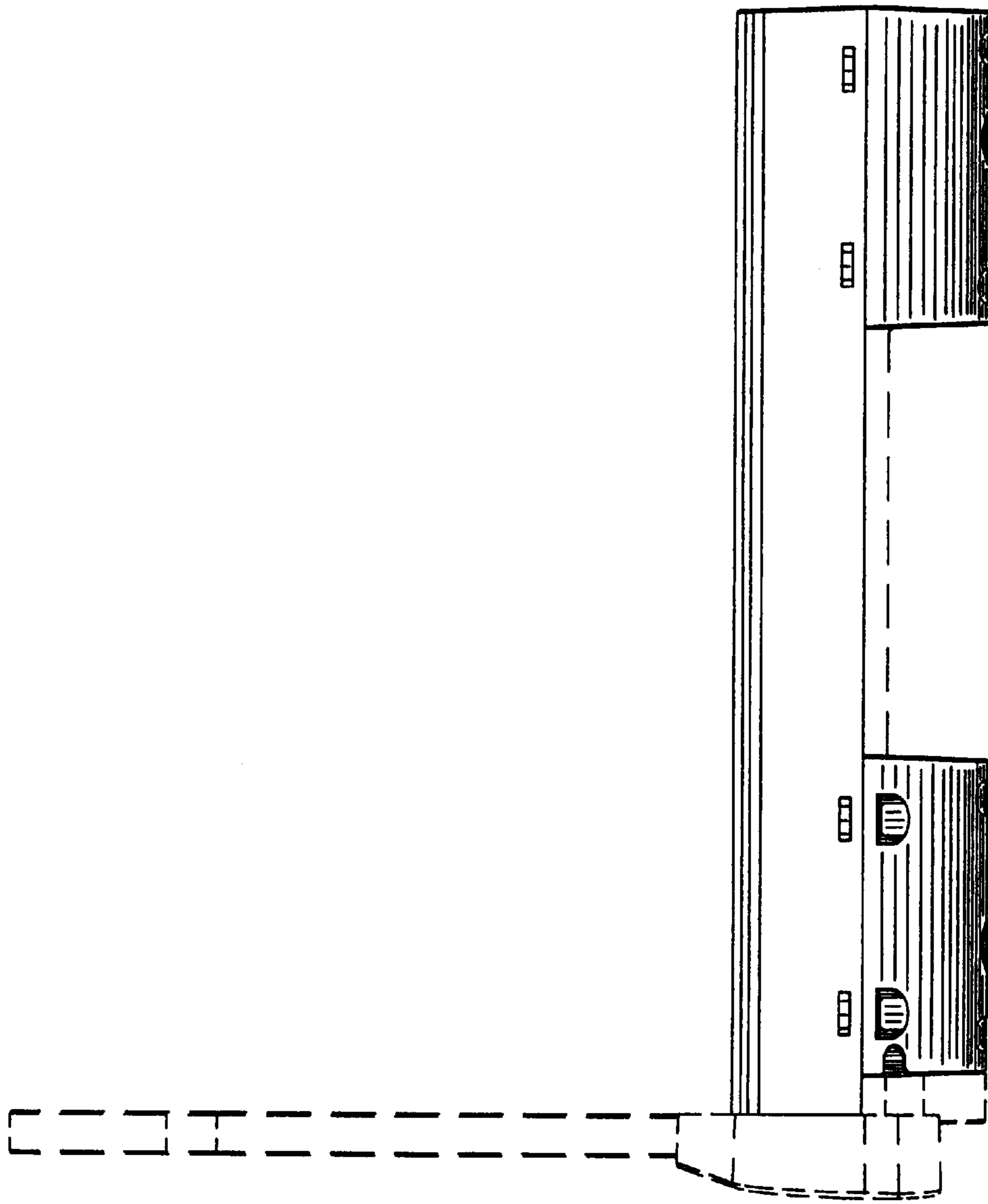

FIG. 4

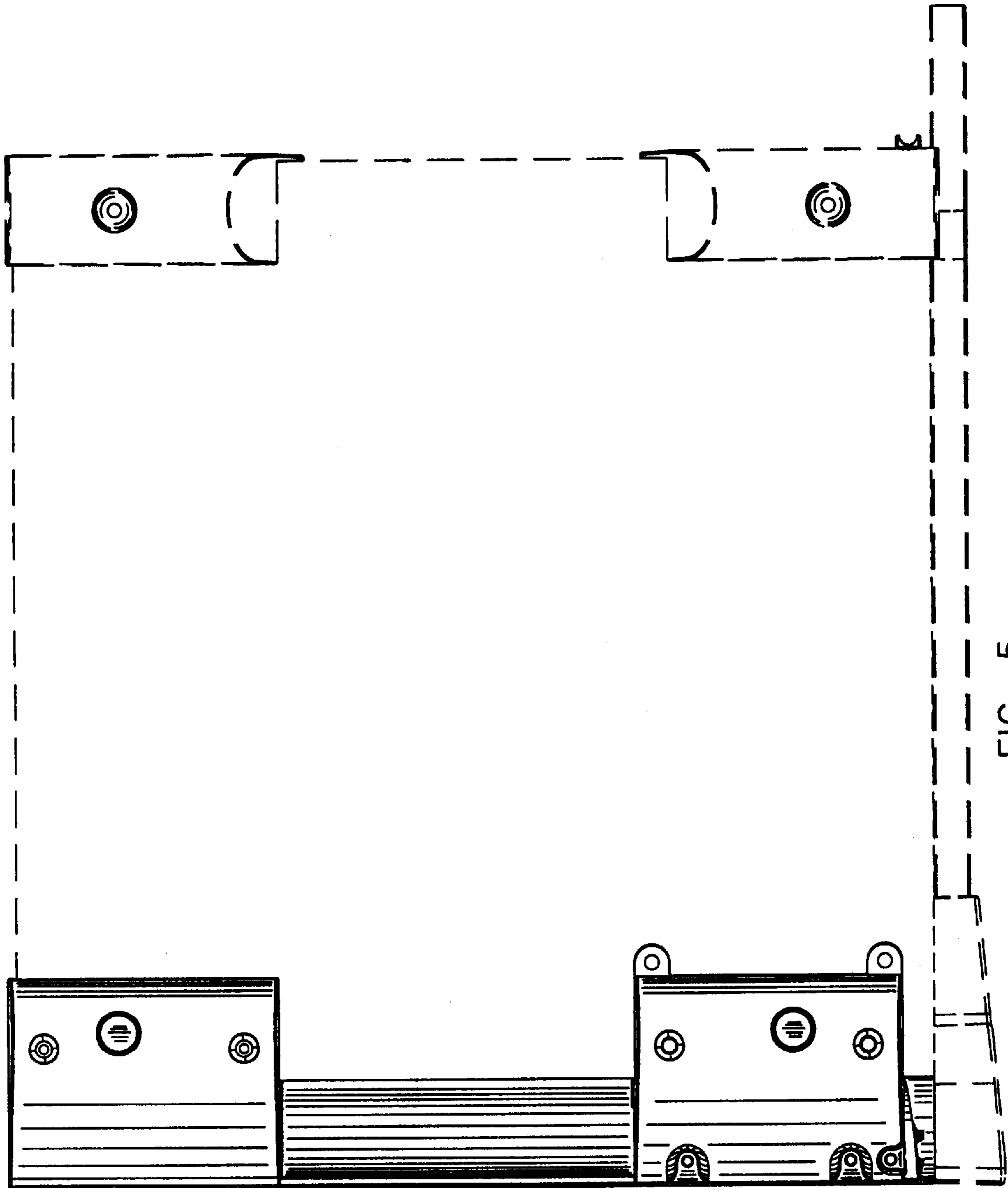

FIG. 5

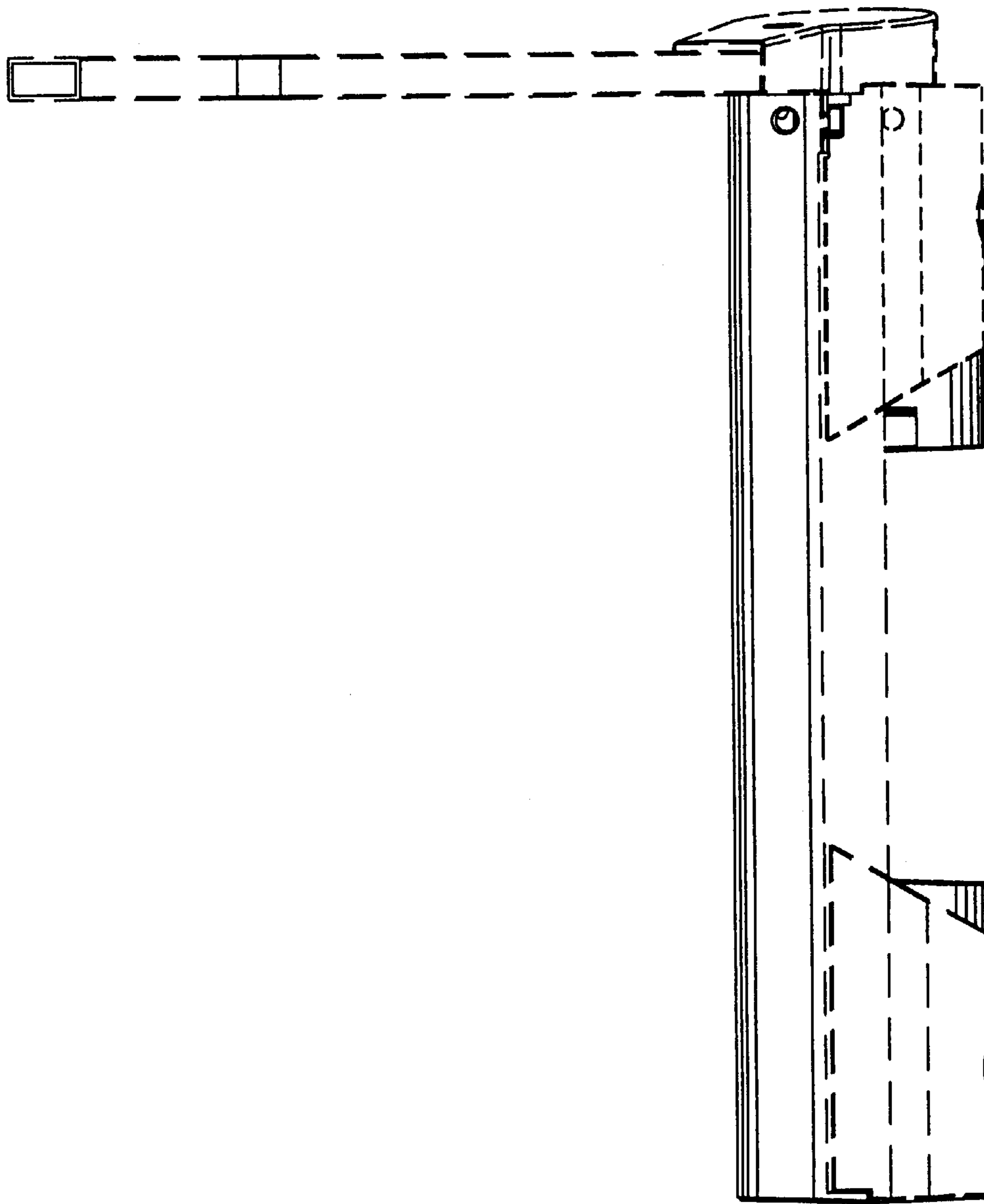

FIG. 6