



US00D479736S

(12) **United States Design Patent**
Sanner et al.

(10) **Patent No.: US D479,736 S**

(45) **Date of Patent: ** Sep. 16, 2003**

(54) **POWDER CHARGE SLEEVE**

(75) Inventors: **Michael R. Sanner**, Amherst, OH (US); **Dale R. Juhn**, North Olmsted, OH (US); **James R. Hollstein**, Oberlin, OH (US); **Harry J. Lader**, Lakewood, OH (US); **William R. Rehman**, Vermillion, OH (US); **Herman E. Turner, Jr.**, Amherst, OH (US)

(73) Assignee: **Nordson Corporation**, Westlake, OH (US)

(**) Term: **14 Years**

(21) Appl. No.: **29/153,884**

(22) Filed: **Nov. 9, 2001**

(51) **LOC (7) Cl.** **22-03**

(52) **U.S. Cl.** **D22/116**

(58) **Field of Search** D22/108, 112, D22/115, 116, 199; 89/1.701, 1.703, 1.704; 102/204, 282, 431, 437, 444, 449, 468, 470, 513, 524, 529

(56) **References Cited**

U.S. PATENT DOCUMENTS

1,298,418 A * 3/1919 Stokes 102/204

2,994,249 A * 8/1961 Schecter et al. 89/1.704
3,216,323 A * 11/1965 Wengenroth 89/1.701
4,233,903 A * 11/1980 Lage 102/449
D298,348 S * 11/1988 Posey D22/116
5,282,423 A * 2/1994 Sikorski 102/431

* cited by examiner

Primary Examiner—Louis S. Zarfaz

Assistant Examiner—Monica A. Weingart

(74) *Attorney, Agent, or Firm*—Calfee, Halter & Griswold LLP

(57) **CLAIM**

We claim the ornamental designs for a powder charge sleeve, as shown.

DESCRIPTION

FIG. 1 is a top plan view of a powder charge sleeve;
FIG. 2 is left side view thereof;
FIG. 3 is a front elevational view thereof;
FIG. 4 is a right side view thereof; and,
FIG. 5 is a bottom plan view thereof.

1 Claim, 1 Drawing Sheet

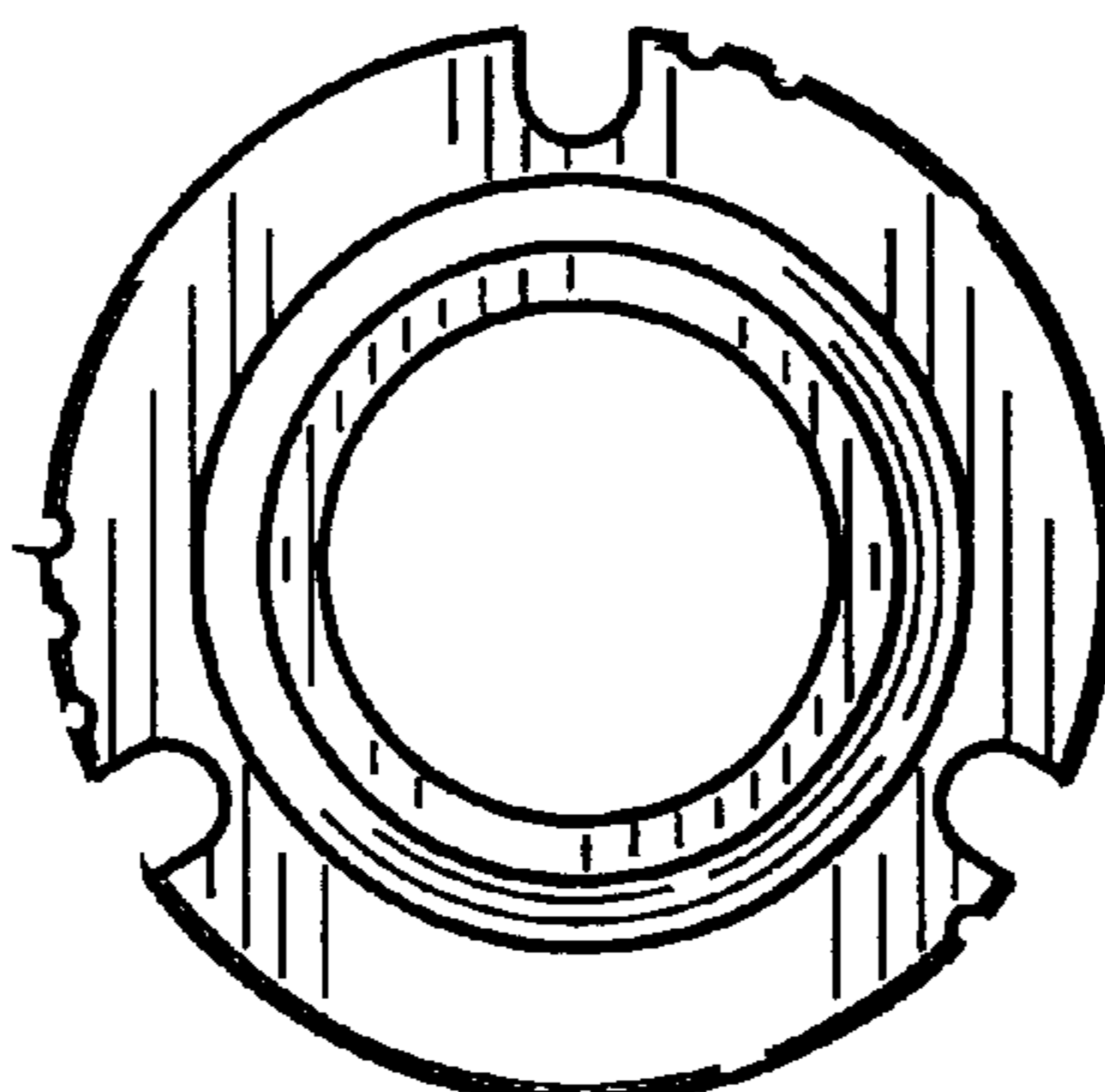
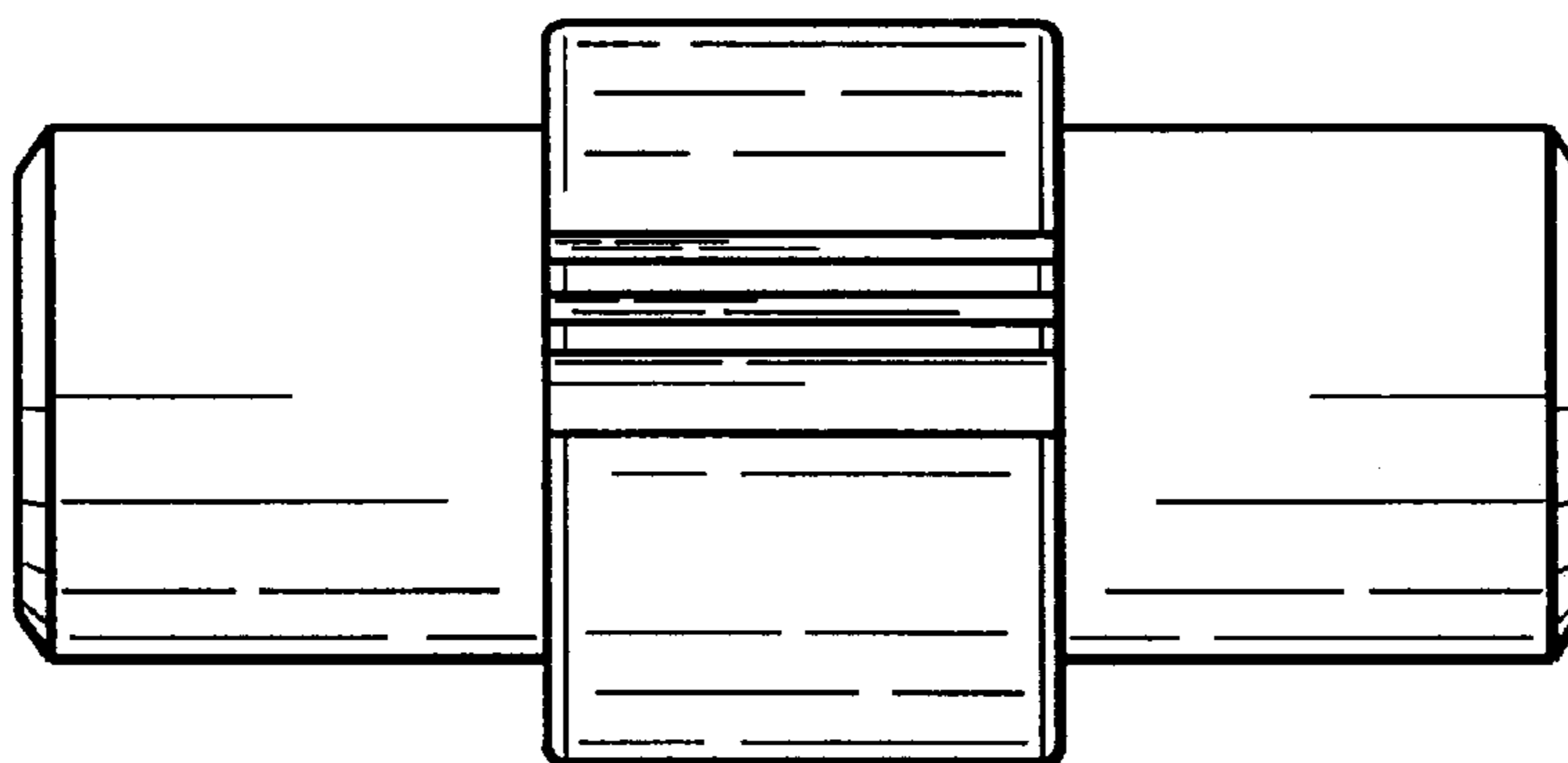

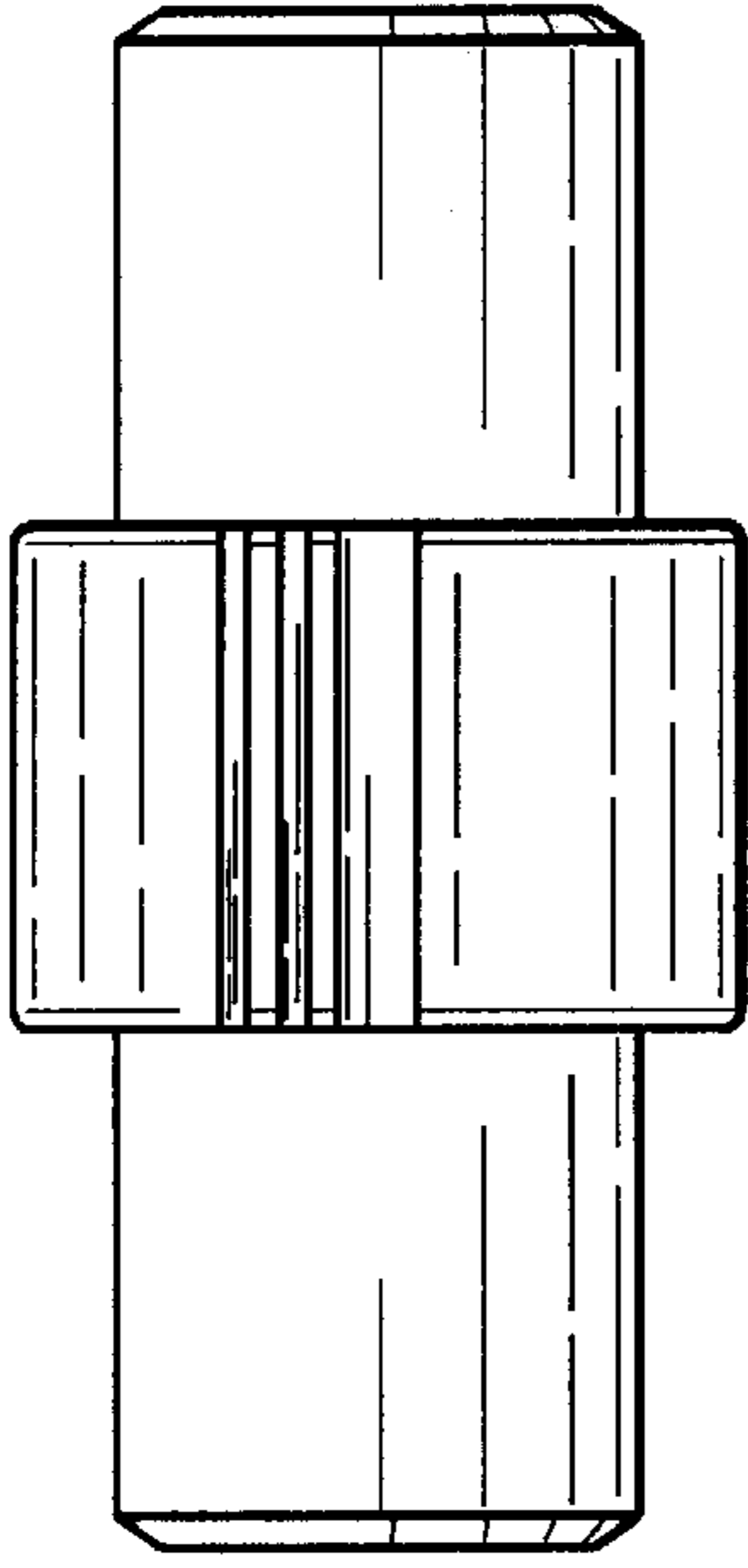

Fig. 1

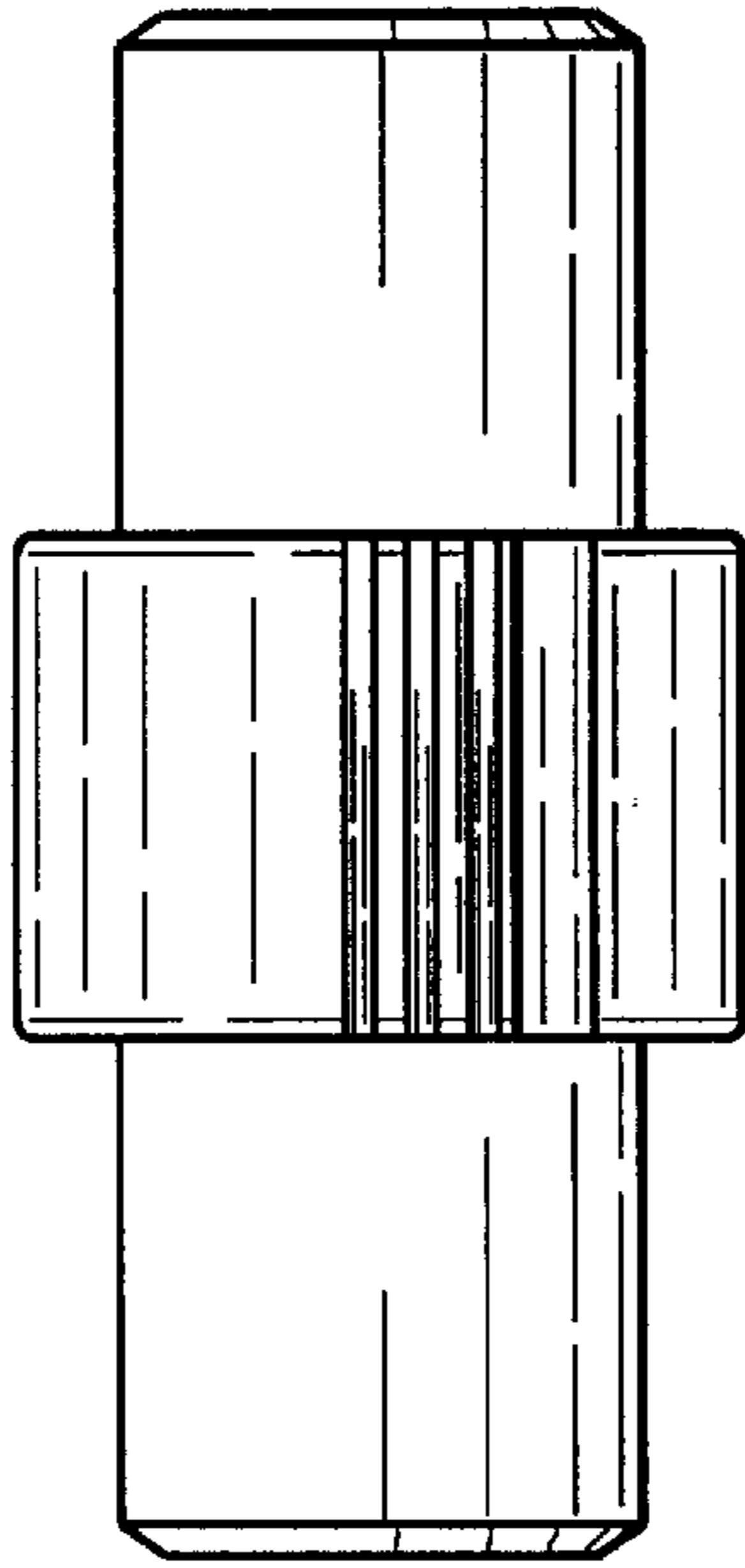

Fig. 2

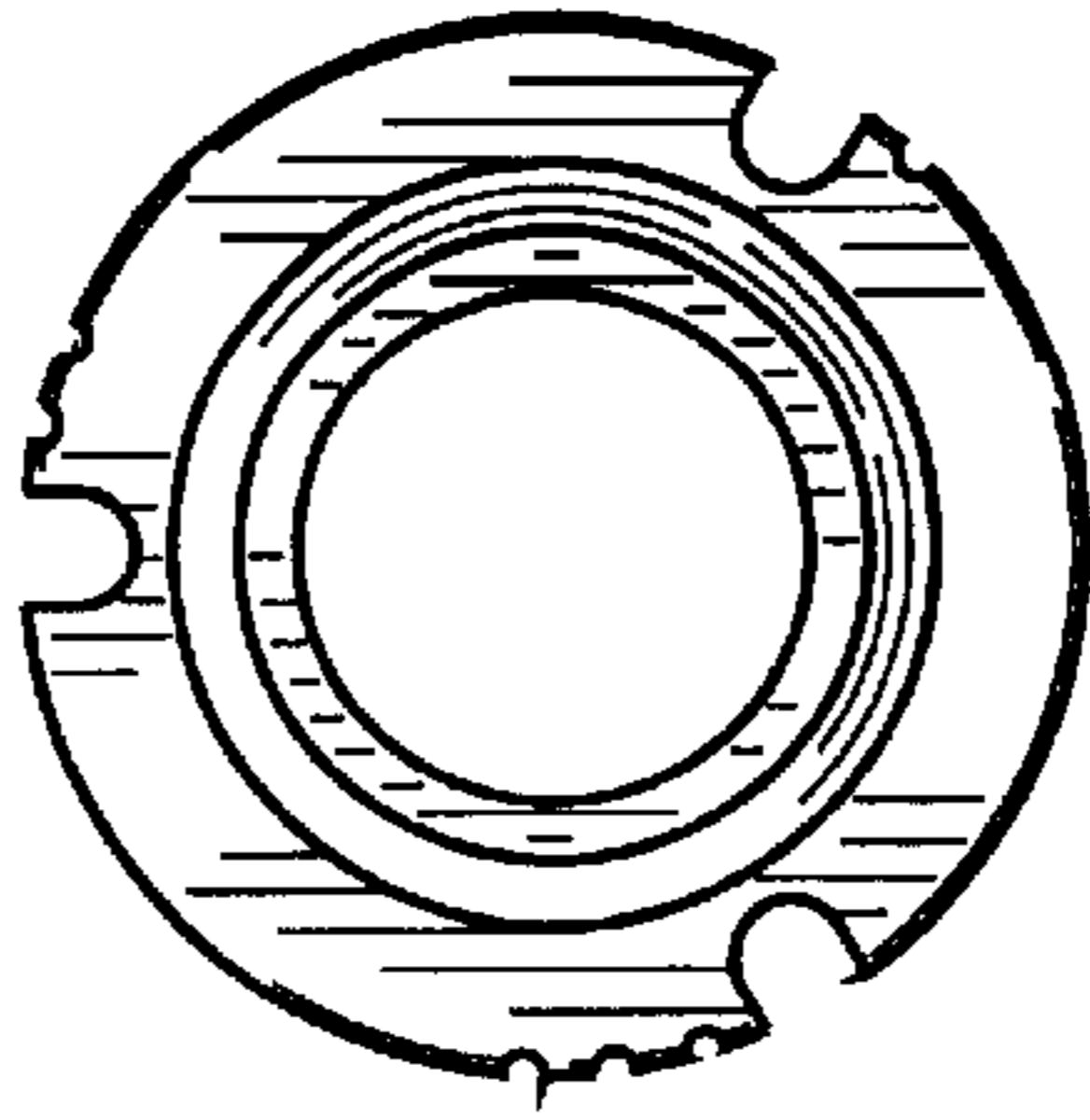

Fig. 3

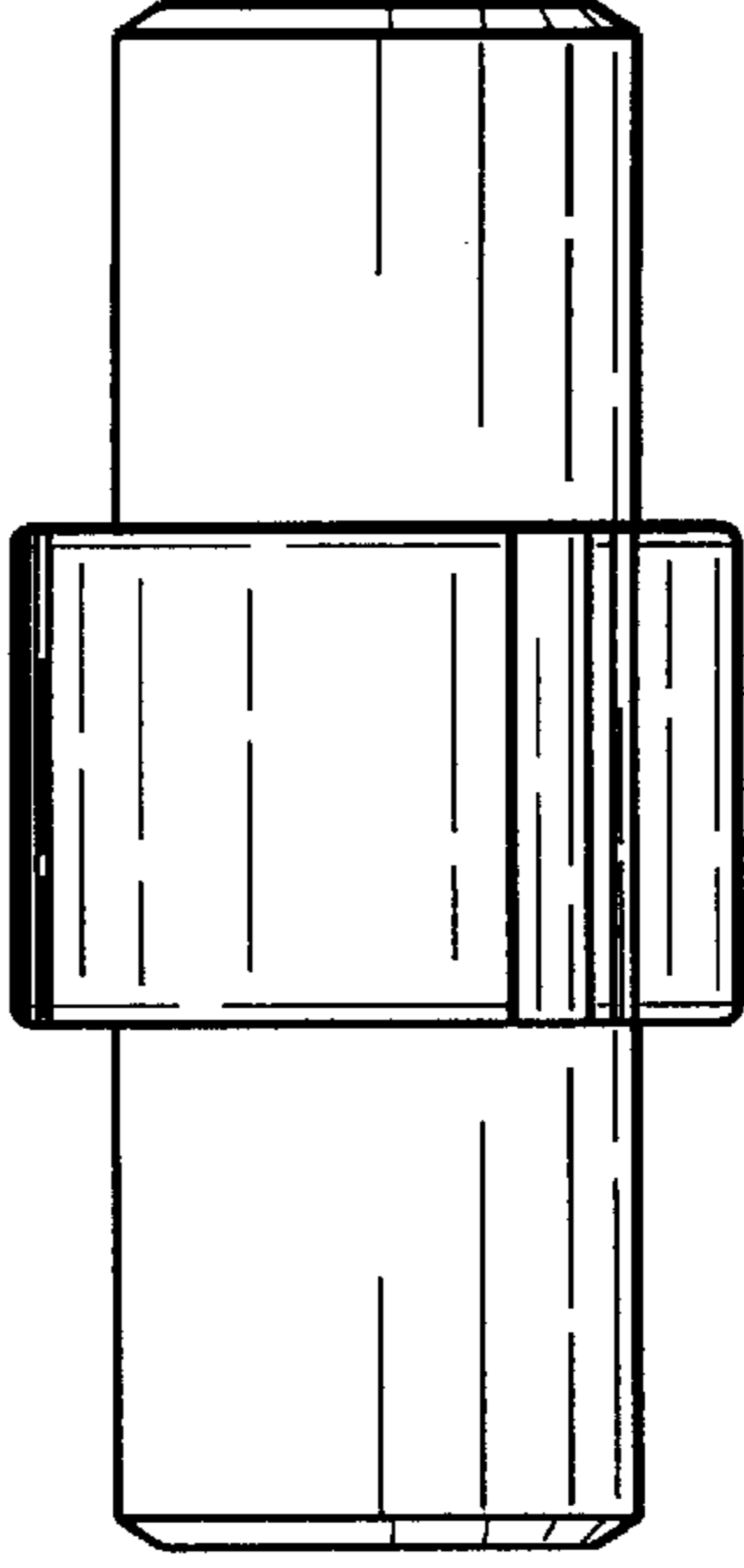

Fig. 4

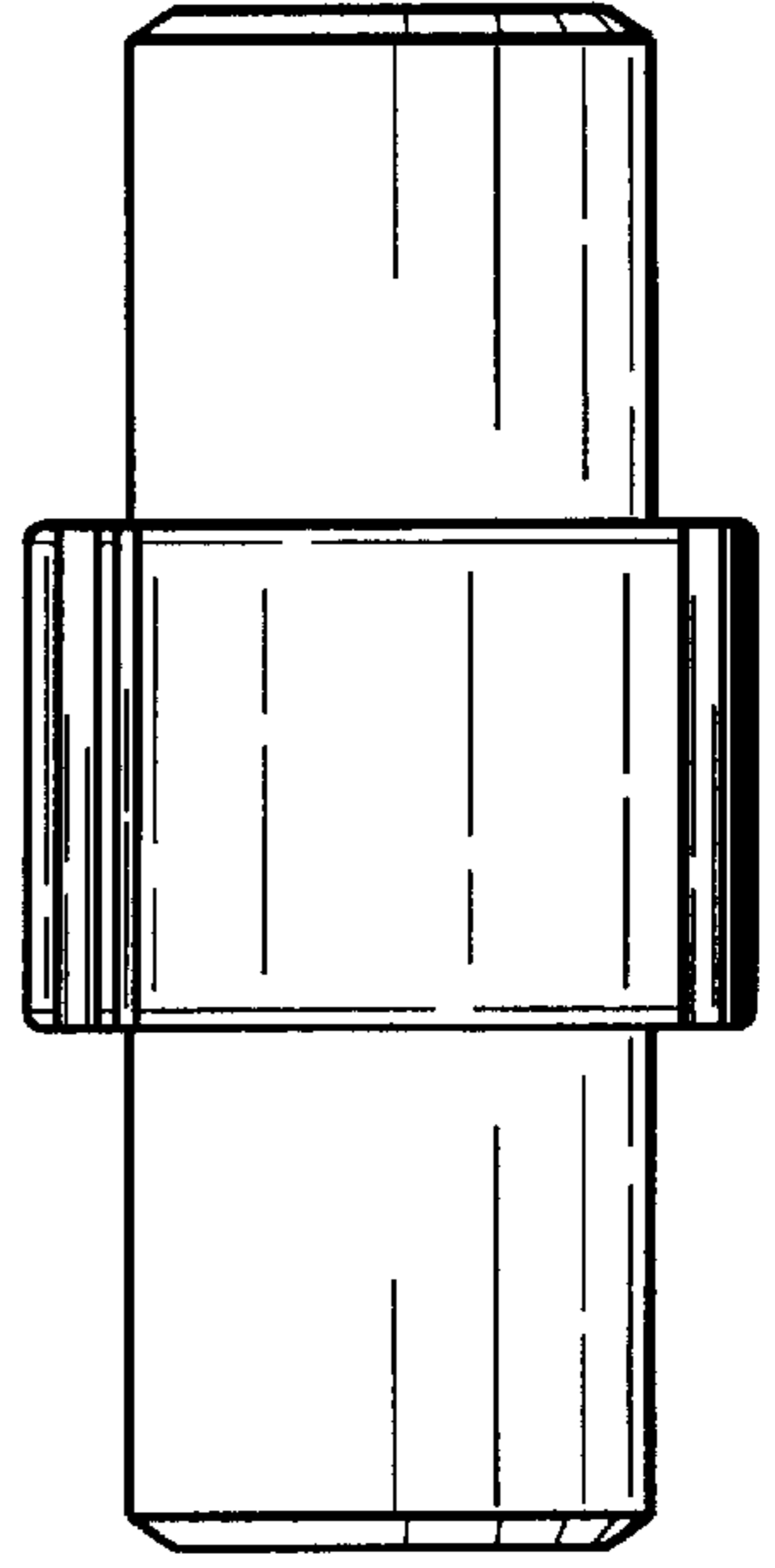

Fig. 5