



US00D479648S

(12) **United States Design Patent**  
**De Lathouwer**

(10) **Patent No.:** **US D479,648 S**

(45) **Date of Patent:** **\*\* \*Sep. 16, 2003**

(54) **RUCKSACK**

6,279,706 B1 \* 8/2001 Mao ..... 190/115

(76) Inventor: **Roger De Lathouwer**, 34 avenue de Versailles, Brussels (BE), 1020

\* cited by examiner

(\* ) Notice: This patent is subject to a terminal disclaimer.

*Primary Examiner*—Celia Murphy

(74) *Attorney, Agent, or Firm*—Horst M. Kasper

(\*\*) Term: **14 Years**

(57) **CLAIM**

The ornamental design for a rucksack, as shown and described.

(21) Appl. No.: **29/142,072**

**DESCRIPTION**

(22) Filed: **May 17, 2001**

(51) **LOC (7) Cl.** ..... **03-01**

(52) **U.S. Cl.** ..... **D3/216; D3/279**

(58) **Field of Search** ..... D3/215–217, 229, D3/327, 230, 232, 233, 213, 289, 279; 224/153, 155, 259, 579, 627–631, 643, 646, 647, 652–653, 657; D2/831

FIG. 1 is a perspective elevational view of a rucksack showing my new design;

FIG. 2 is a front view thereof;

FIG. 3 is a rear view thereof;

FIG. 4 is a right side elevational view thereof;

FIG. 5 is a left side elevational view thereof;

FIG. 6 is a bottom view thereof;

FIG. 7 is a top view thereof;

FIG. 8 is a perspective view thereof, the telescopic handle shown extended and the straps disengaged, and stowed in the rear pocket;

FIG. 9 is a front elevational view of FIG. 8;

FIG. 10 is a rear view of FIG. 8;

FIG. 11 is a left side elevational view of FIG. 8;

FIG. 12 is a right side elevational view of FIG. 8;

FIG. 13 is a bottom view of FIG. 8;

FIG. 14 is a top view of FIG. 8; and,

FIG. 15 is a perspective view of FIG. 8, the straps being reattached.

The broken lines shown on the claimed article throughout the views are understood to represent stitching.

(56) **References Cited**

**U.S. PATENT DOCUMENTS**

D323,237 S	*	1/1992	Zoltie	.....	D2/831
5,447,261 A	*	9/1995	Mitomi et al.	.....	224/153
D375,402 S	*	11/1996	Yeh	.....	D3/217
5,588,569 A	*	12/1996	Mitomi et al.	.....	224/153
5,676,286 A	*	10/1997	Song	.....	224/153
D387,198 S	*	12/1997	Lehmann et al.	.....	D3/217
5,706,992 A	*	1/1998	Moor	.....	224/657
5,743,447 A	*	4/1998	McDermott	.....	224/153
5,749,503 A	*	5/1998	Wulf et al.		
D399,053 S	*	10/1998	Moraes	.....	D3/216
5,984,154 A	*	11/1999	Scicluna	.....	224/153
6,179,176 B1	*	1/2001	Saggese et al.	.....	224/153
D441,190 S	*	5/2001	Eskandry	.....	D3/289

**1 Claim, 15 Drawing Sheets**

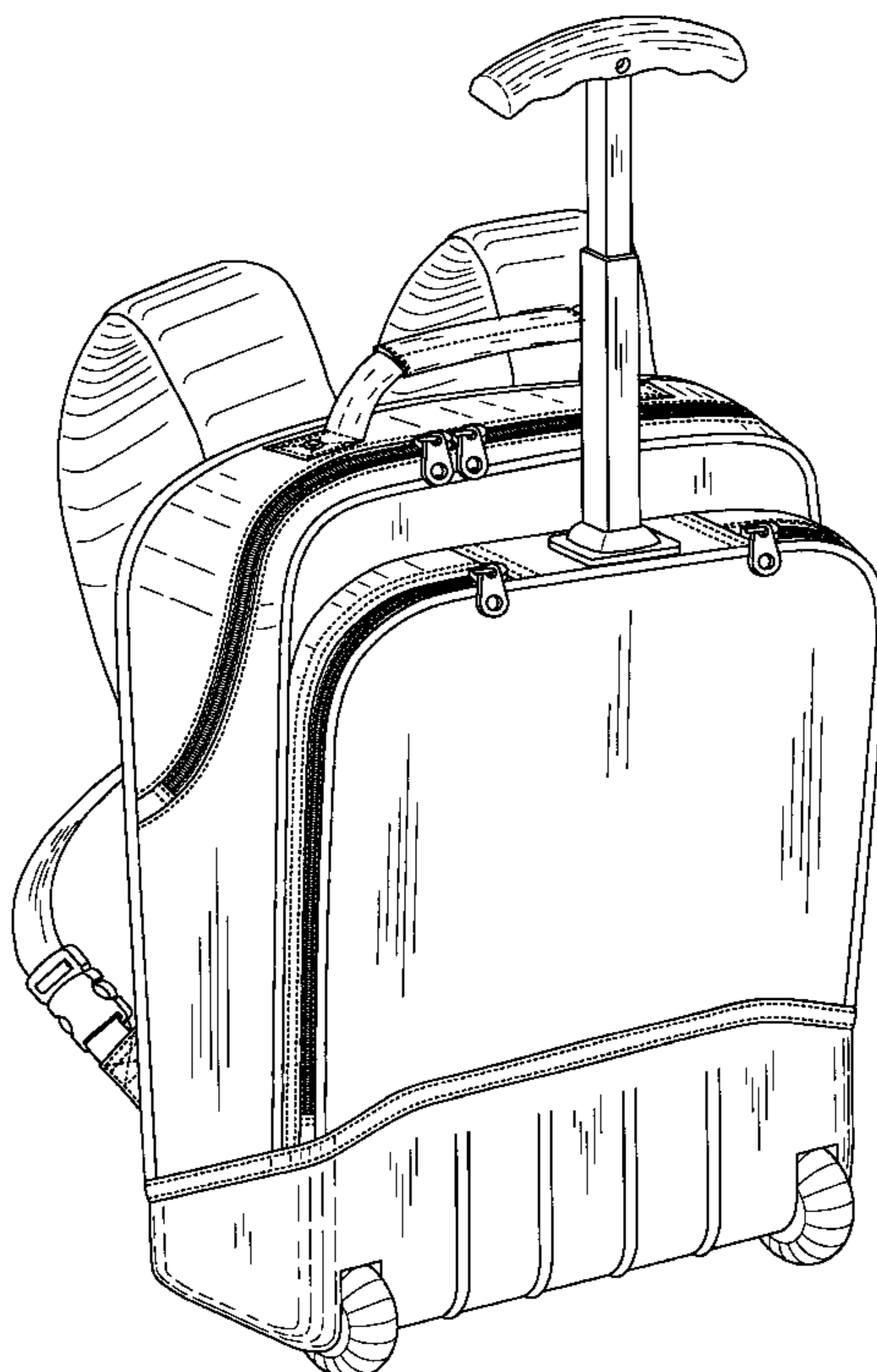

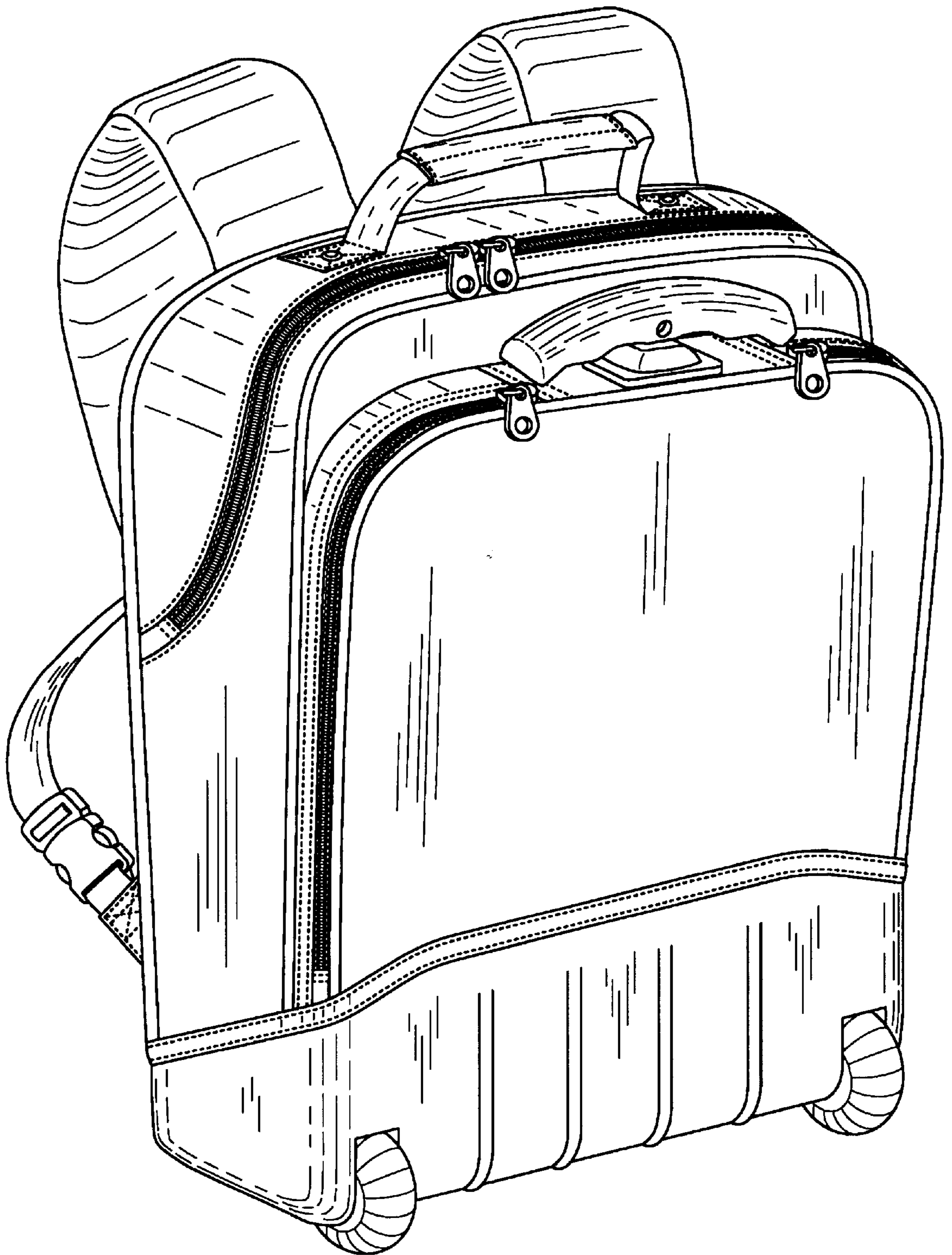

Fig.1

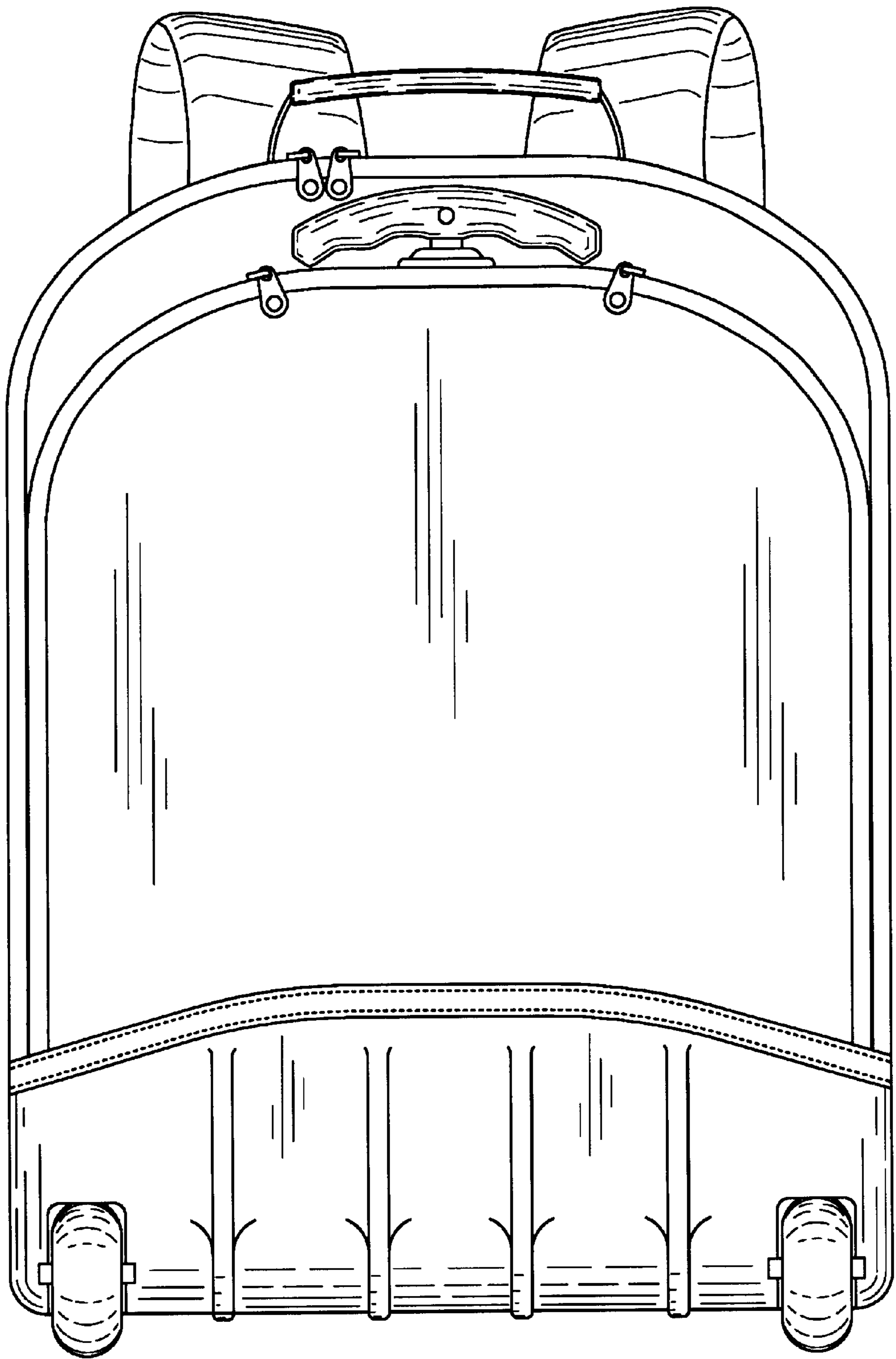

Fig.2



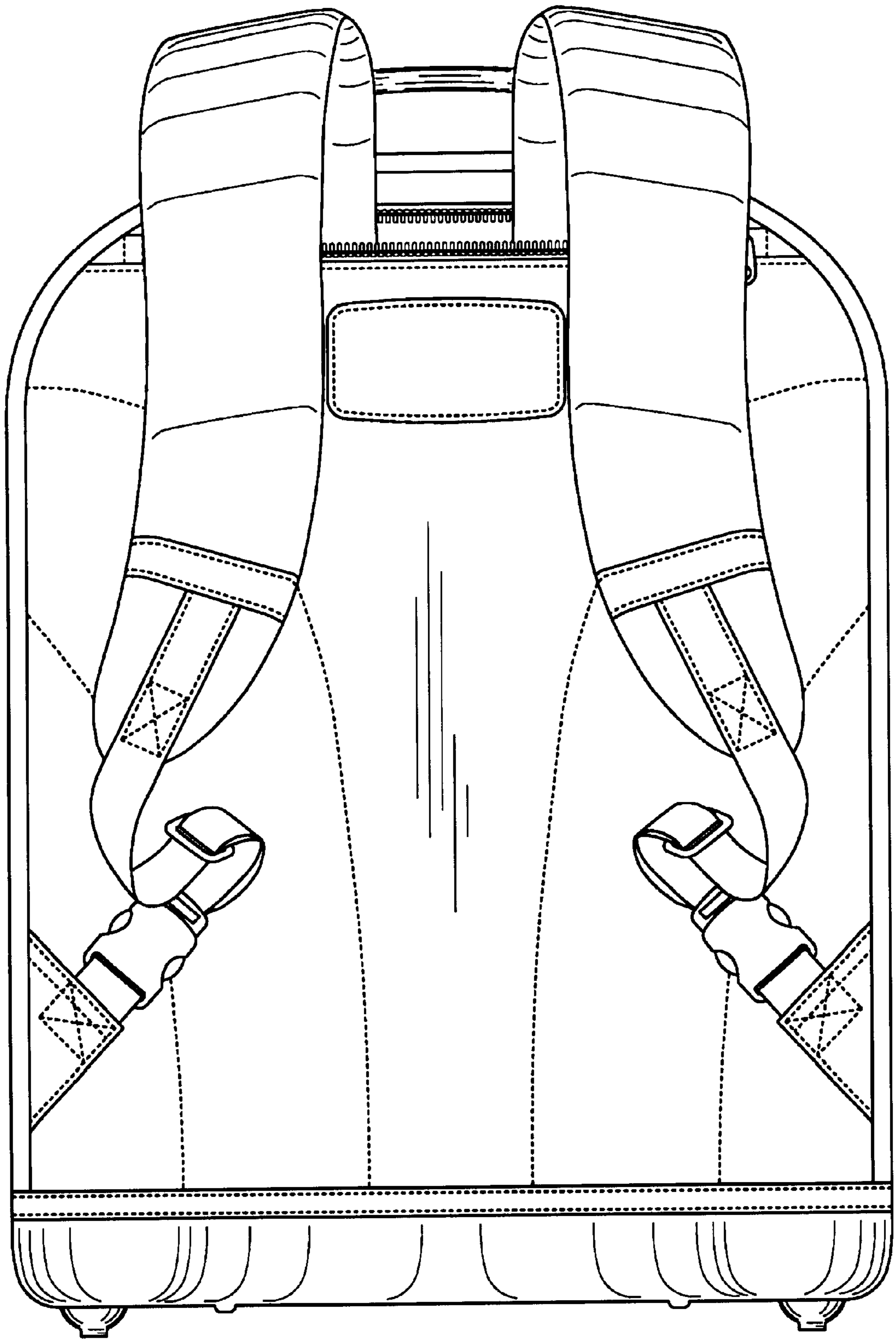

Fig.3

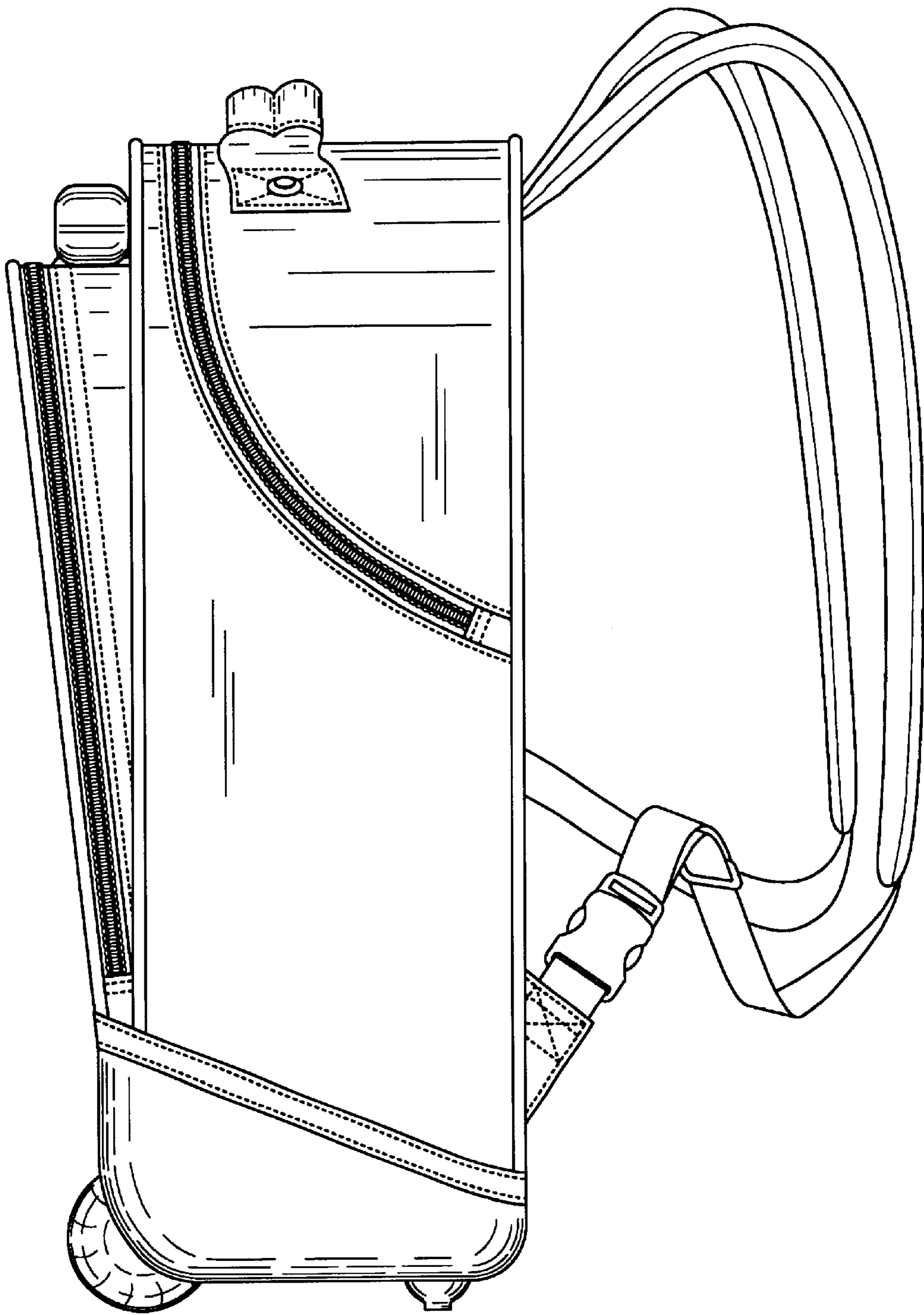

Fig.4

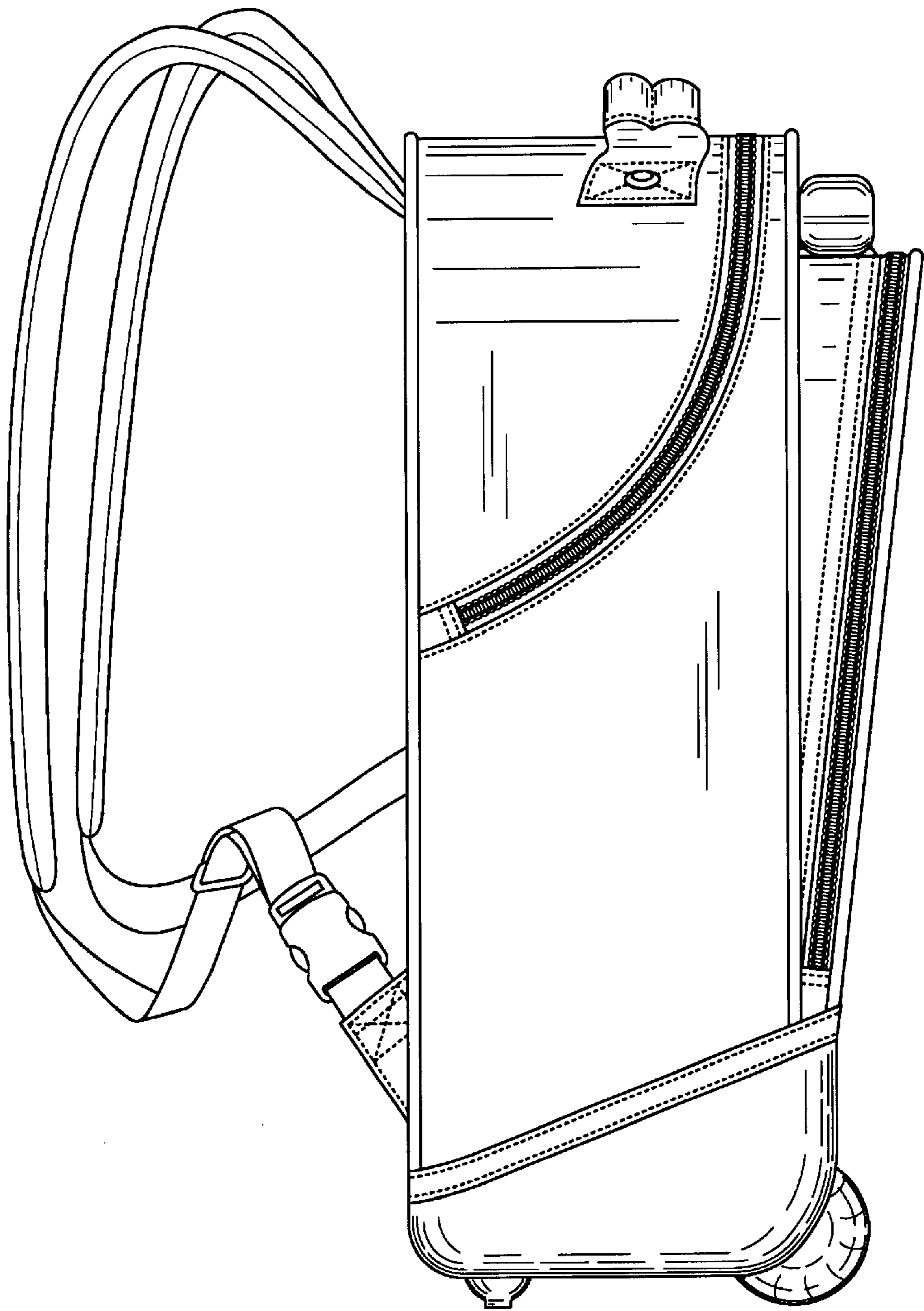

Fig.5

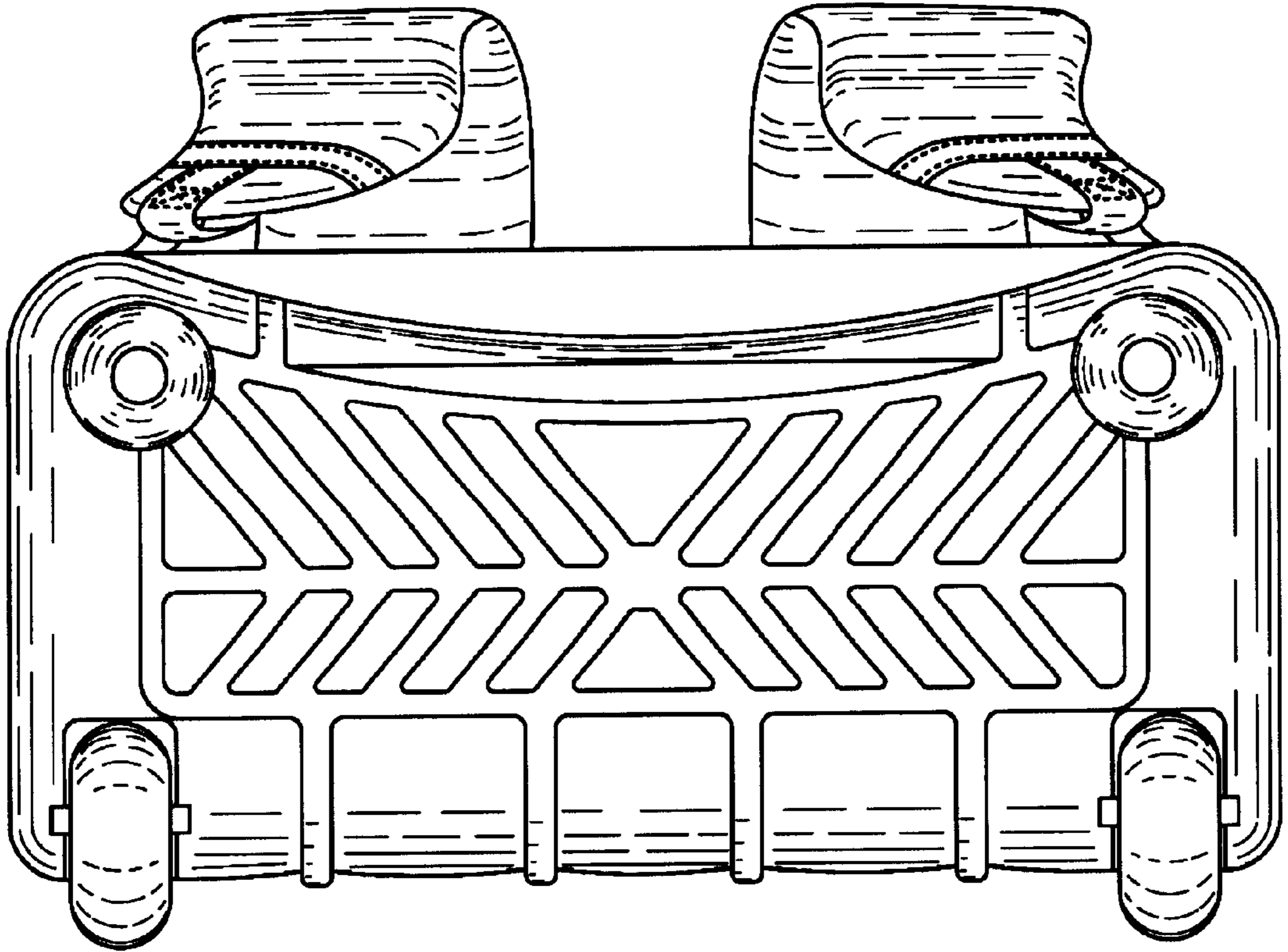

Fig.6

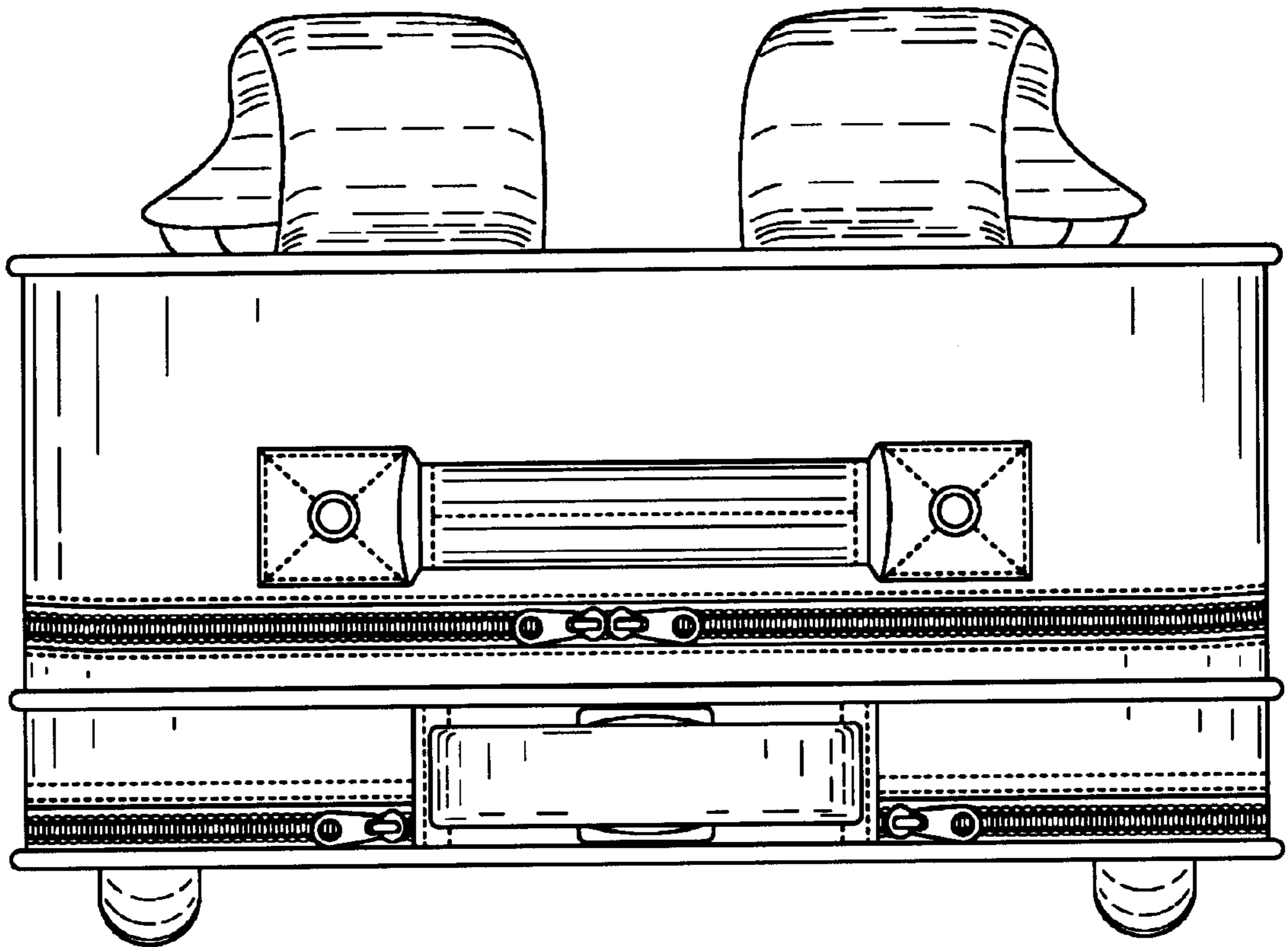

Fig.7



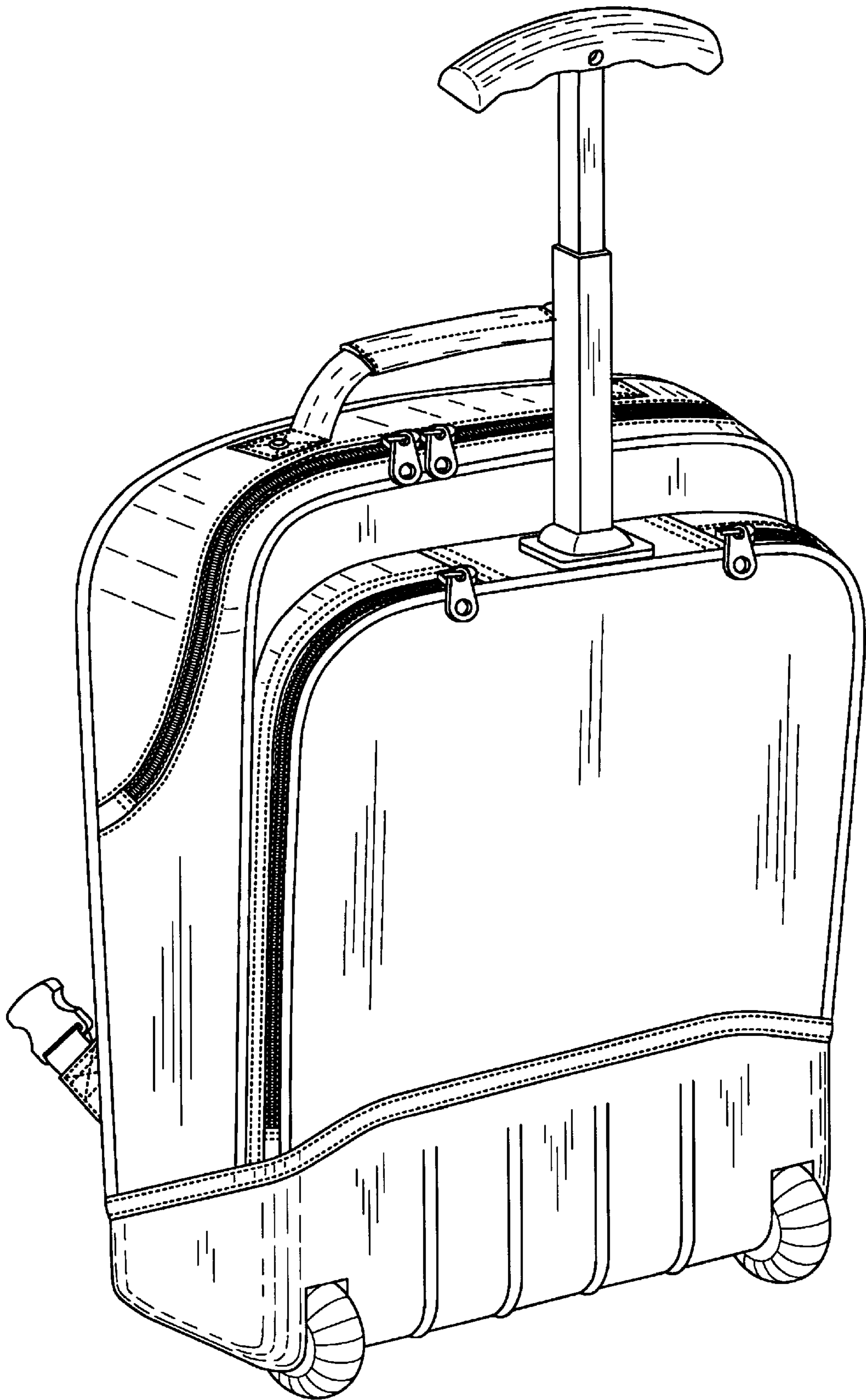

Fig.8

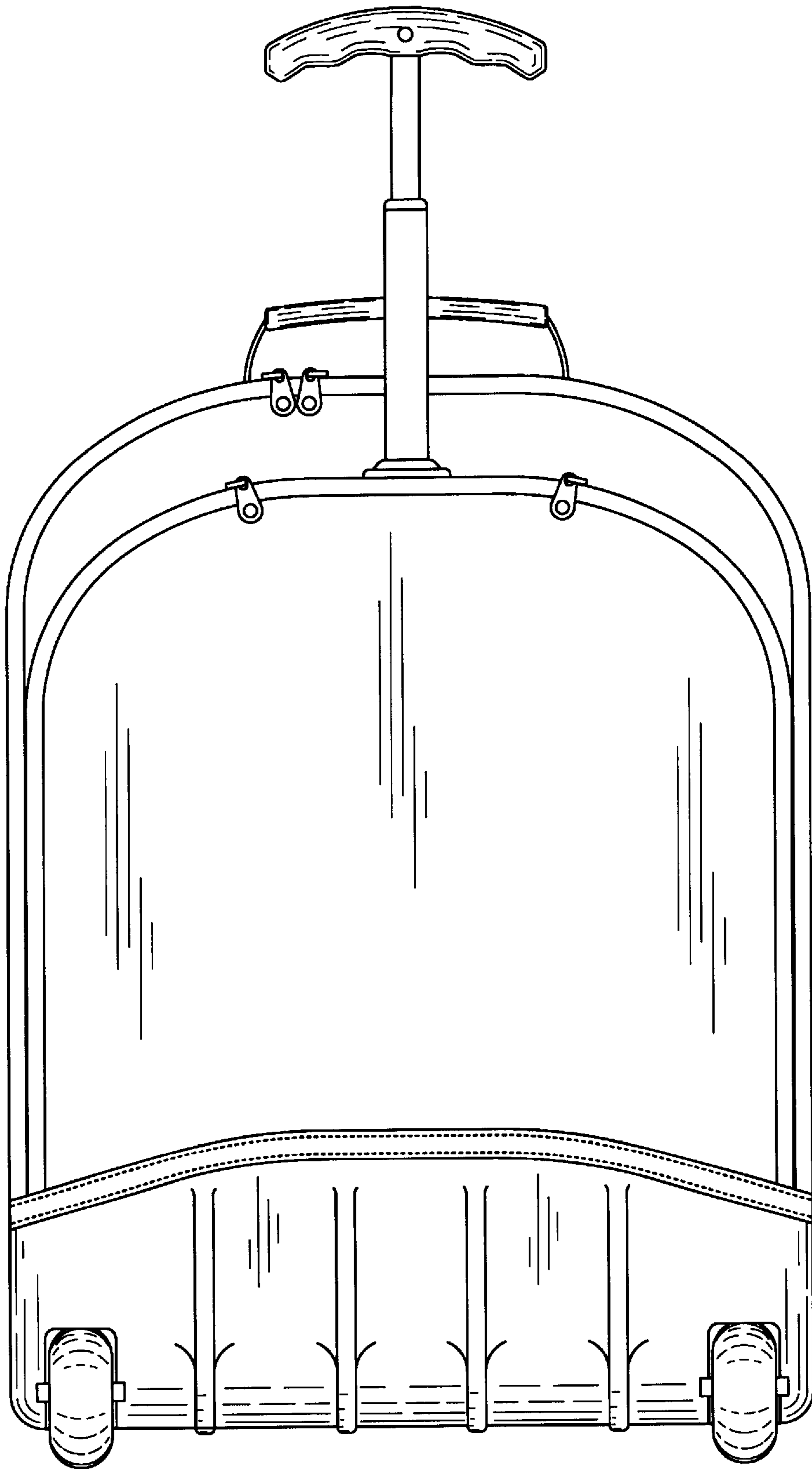

Fig.9

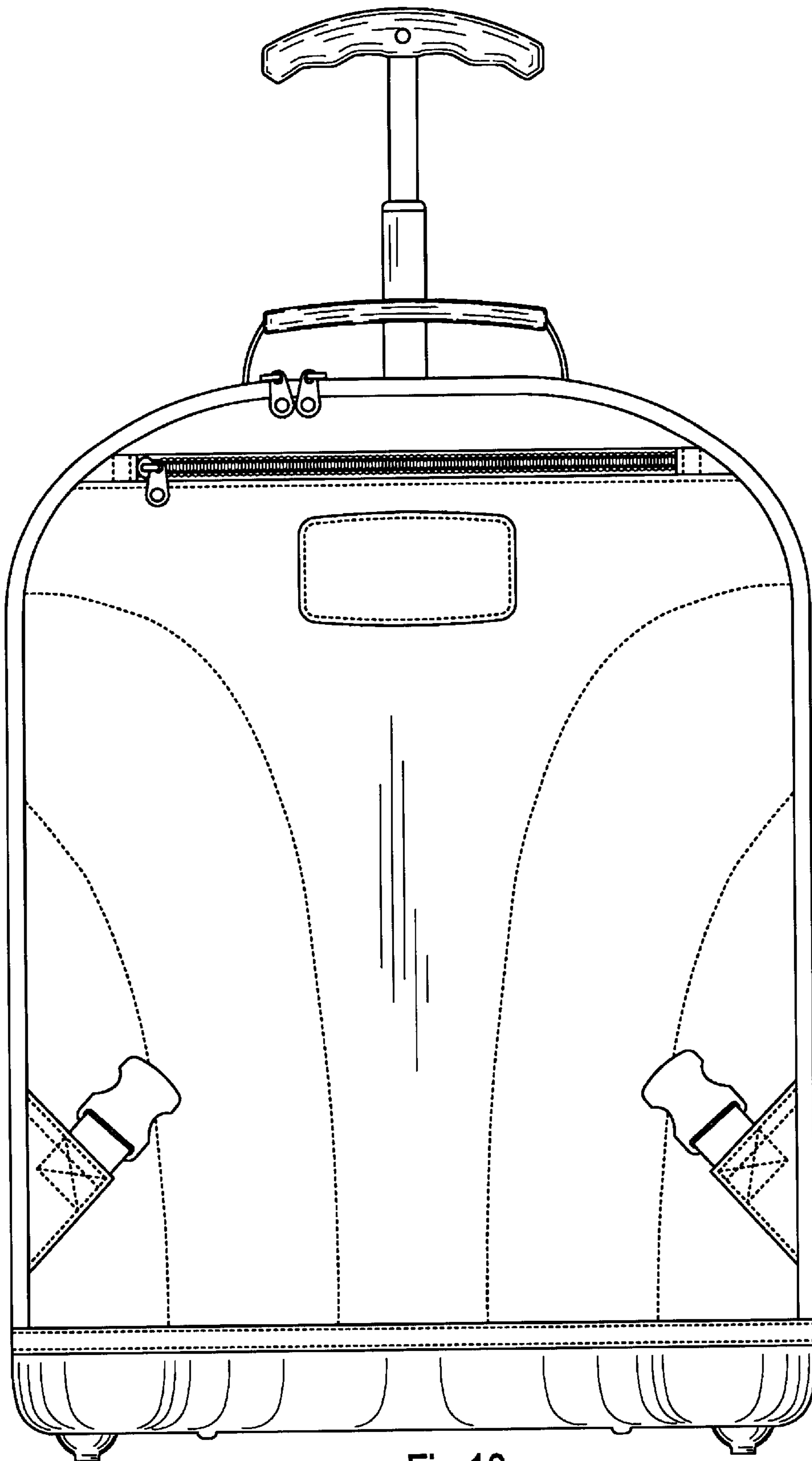

Fig.10

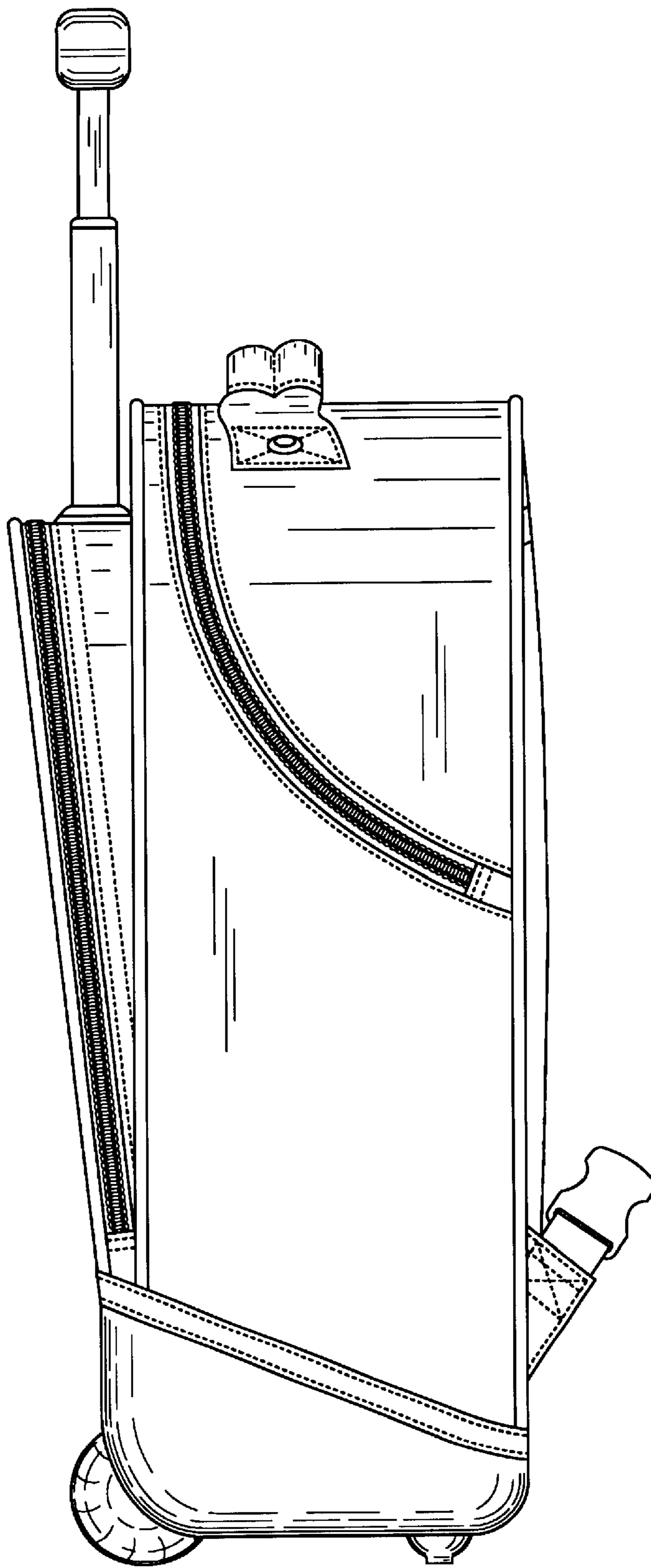

Fig.11



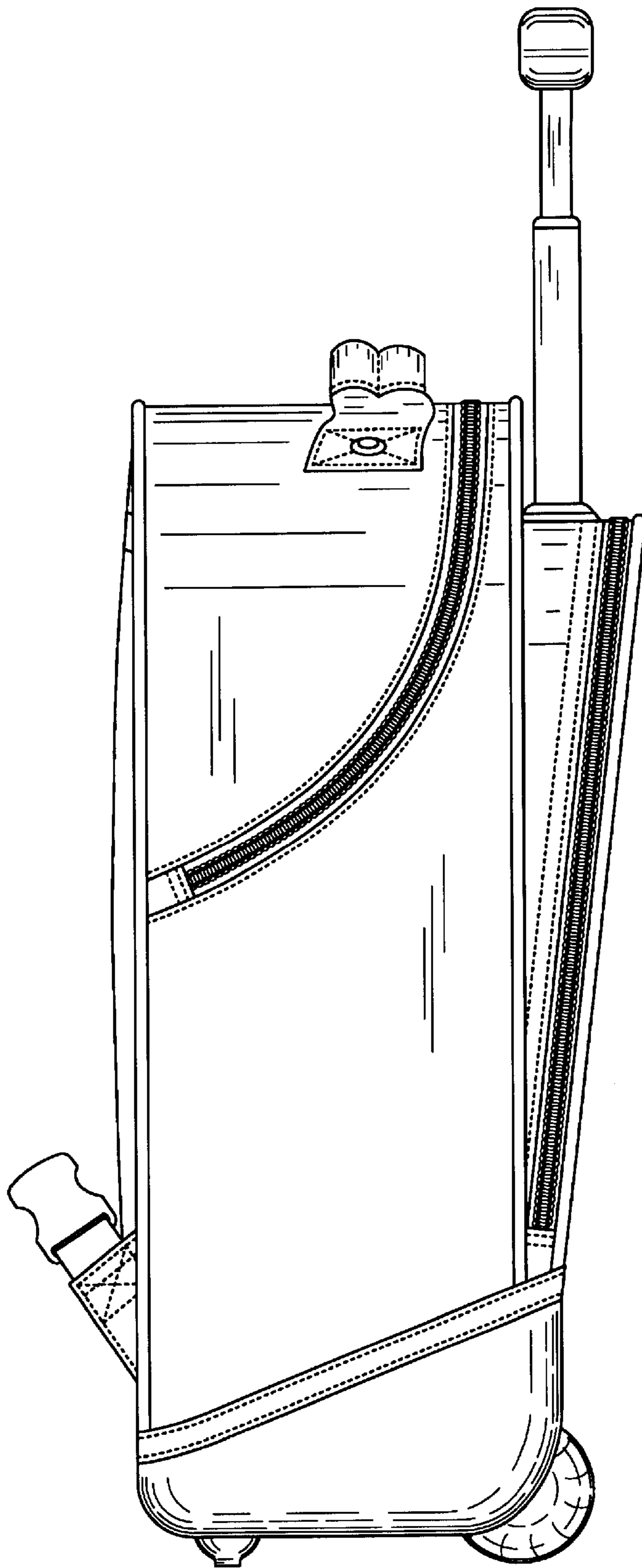

Fig.12

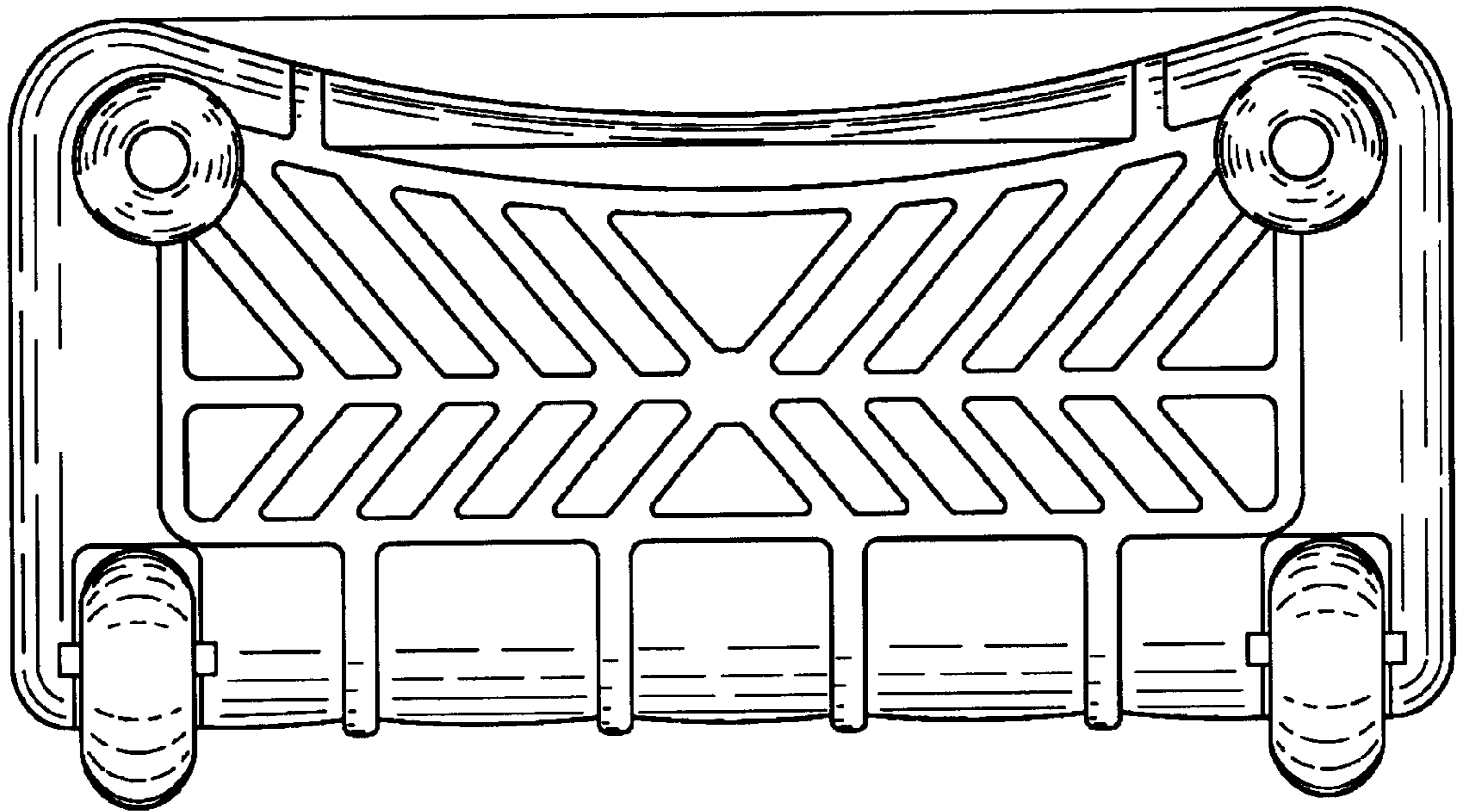

Fig.13

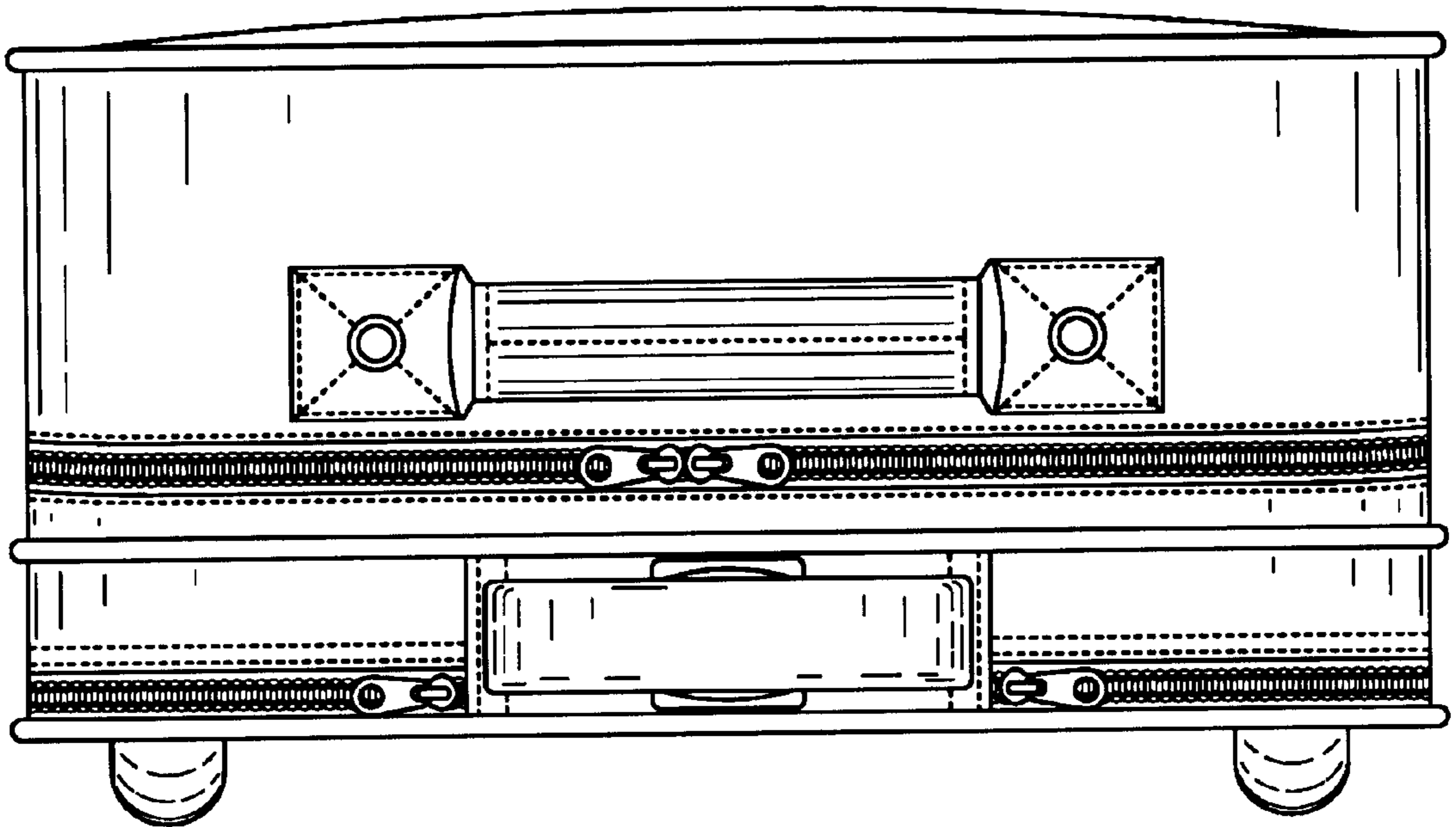

Fig.14

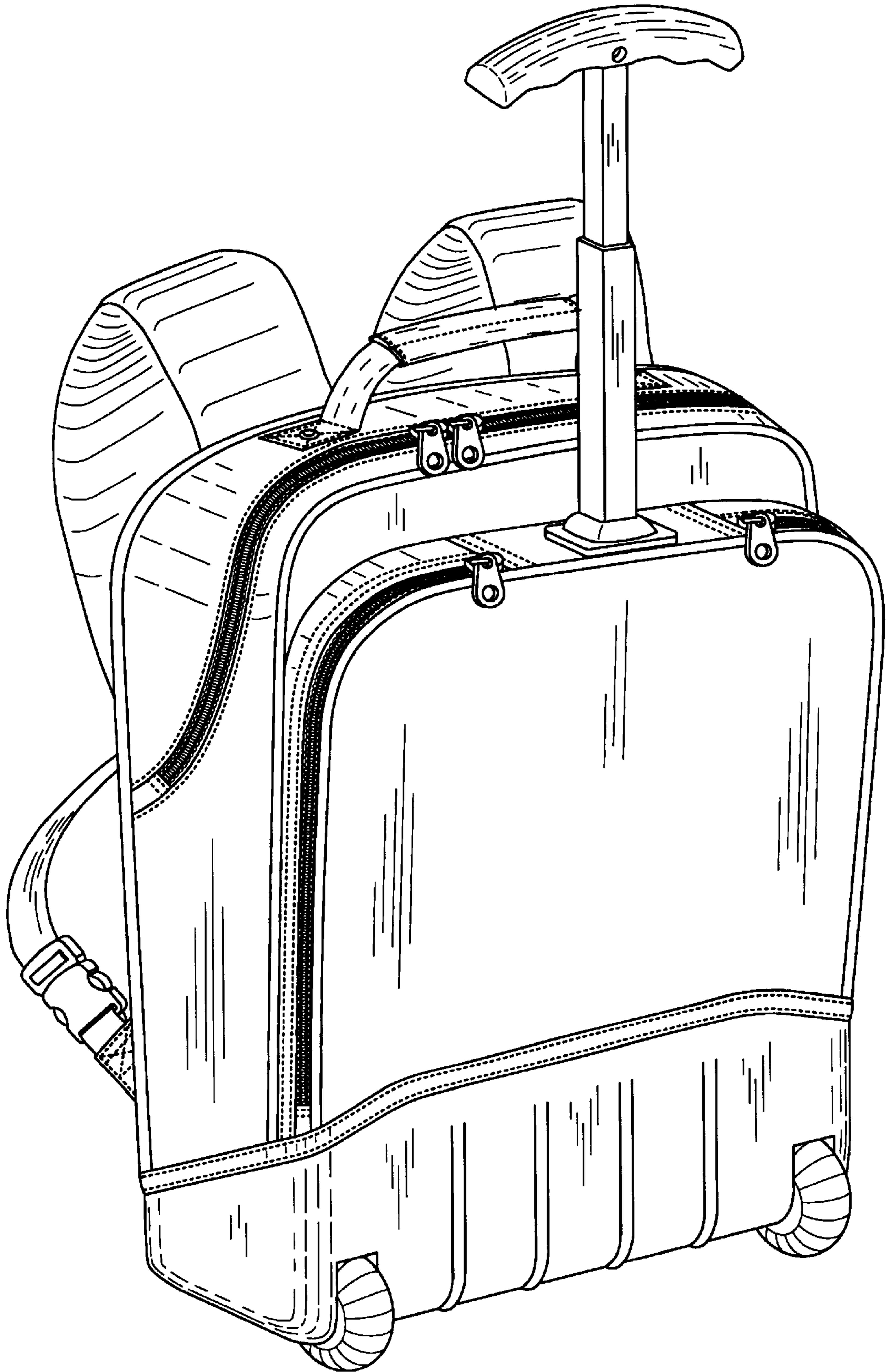

Fig.15