



US00D479621S

(12) **United States Design Patent**
Huang

(10) **Patent No.:** **US D479,621 S**

(45) **Date of Patent:** **** Sep. 9, 2003**

(54) **SUPPORT FRAME OF A TABLE LAMP**

D436,677 S * 1/2001 Huo-Tu D26/63

(75) Inventor: **Huo-Tu Huang**, Taipei Hsien (TW)

* cited by examiner

(73) Assignee: **Huangslite Industrial Co., Ltd.**, Taipei Hsien (TW)

Primary Examiner—Jennifer Rivard
(74) *Attorney, Agent, or Firm*—Bacon & Thomas, PLLC

(**) Term: **14 Years**

(57) **CLAIM**

(21) Appl. No.: **29/166,782**

The ornamental design for a support frame of a table lamp, as shown and described.

(22) Filed: **Sep. 5, 2002**

DESCRIPTION

(51) **LOC (7) Cl.** **26-05**

(52) **U.S. Cl.** **D26/61; D26/138**

(58) **Field of Search** D26/138, 145, D26/155, 61, 63; 362/427, 418, 419, 413

FIG. 1 is a top, front right side perspective view thereof;
FIG. 2 is a front elevational view thereof;
FIG. 3 is a rear elevational view thereof;
FIG. 4 is a left elevational view thereof;
FIG. 5 is a right elevational view thereof;
FIG. 6 is a top plan view thereof; and,
FIG. 7 is a bottom plan view thereof.

(56) **References Cited**

U.S. PATENT DOCUMENTS

5,871,274 A * 2/1999 Lee et al. 362/413
D436,205 S * 1/2001 Huang D26/63

1 Claim, 7 Drawing Sheets

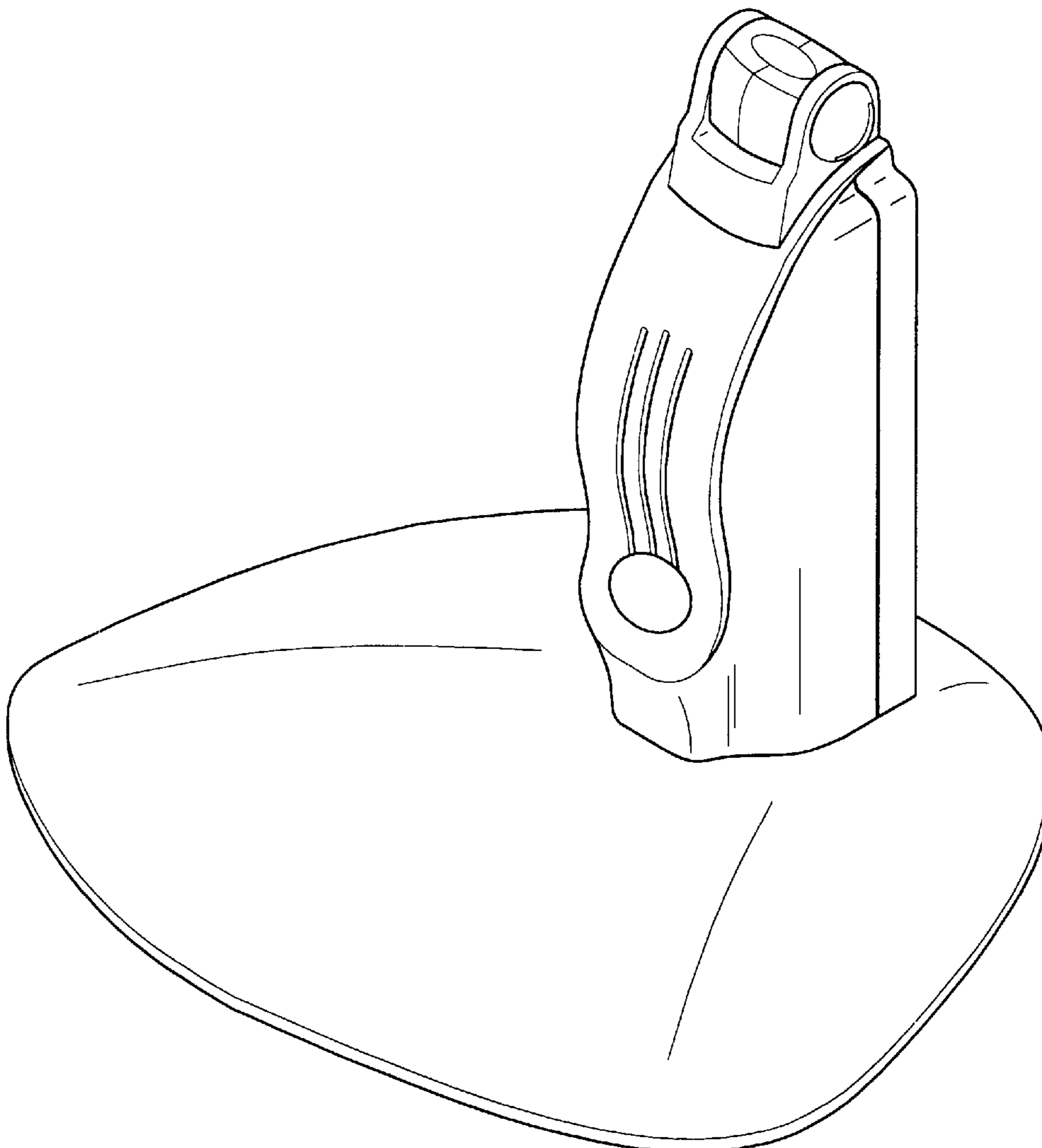

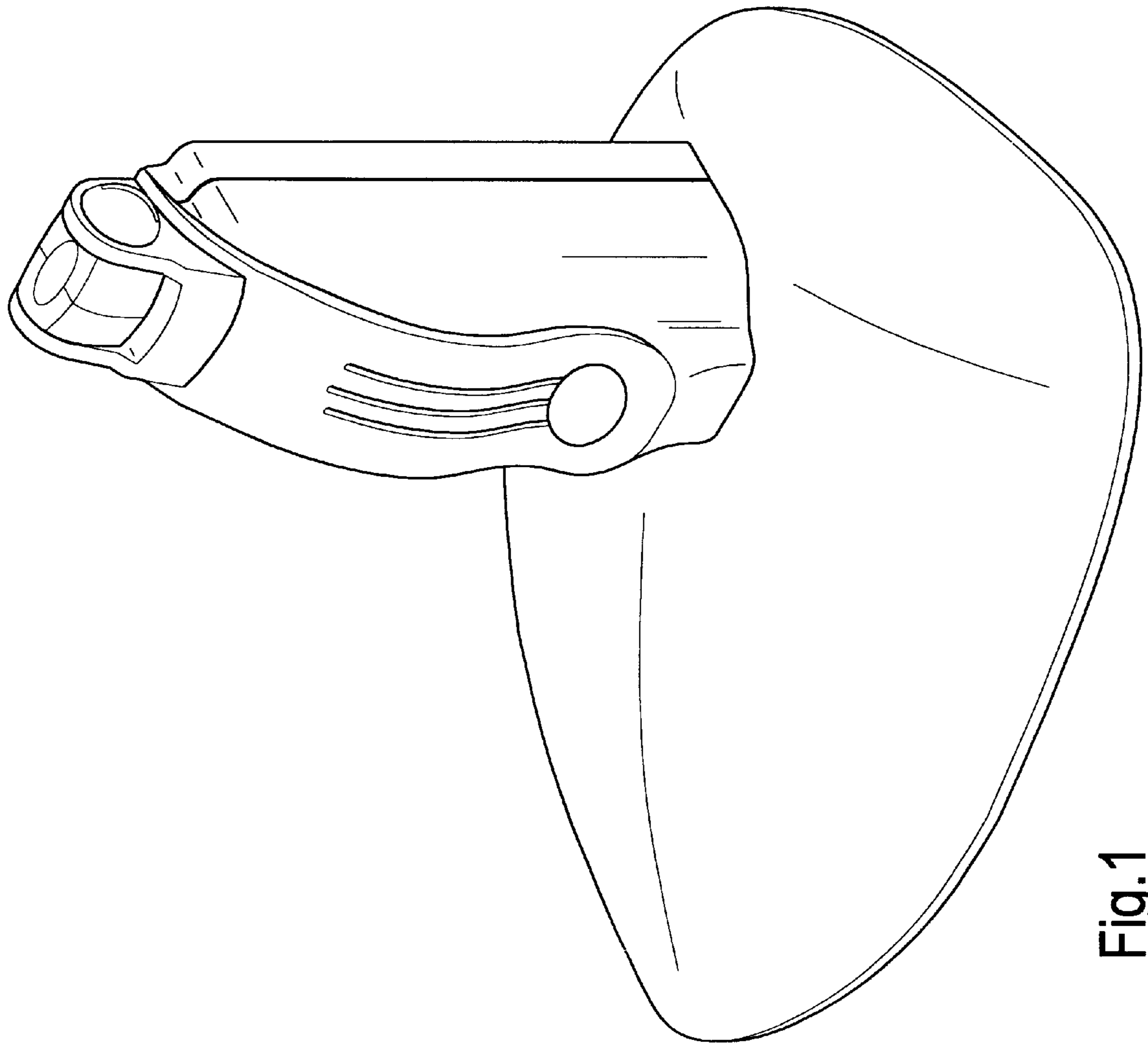

Fig.1

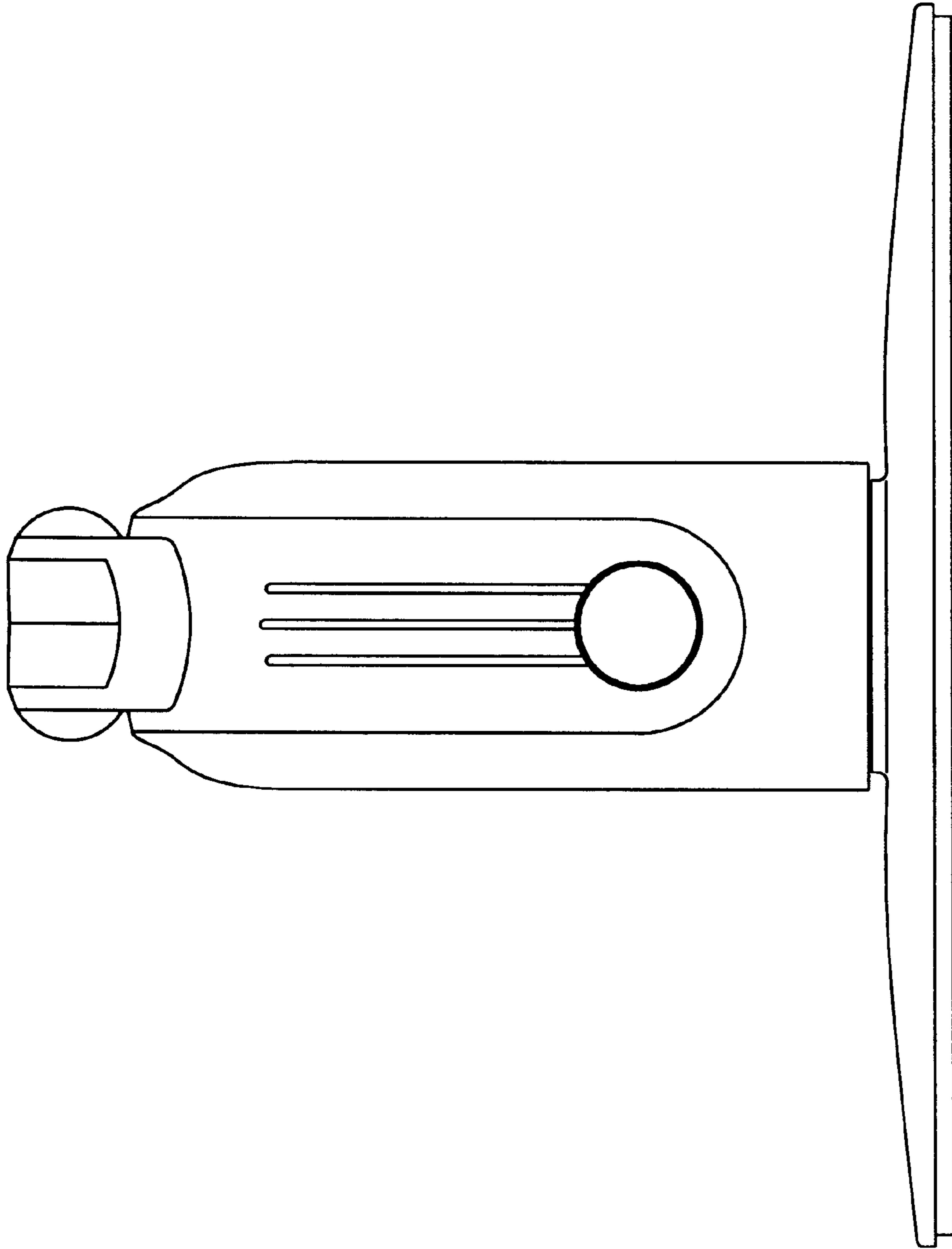

Fig.2

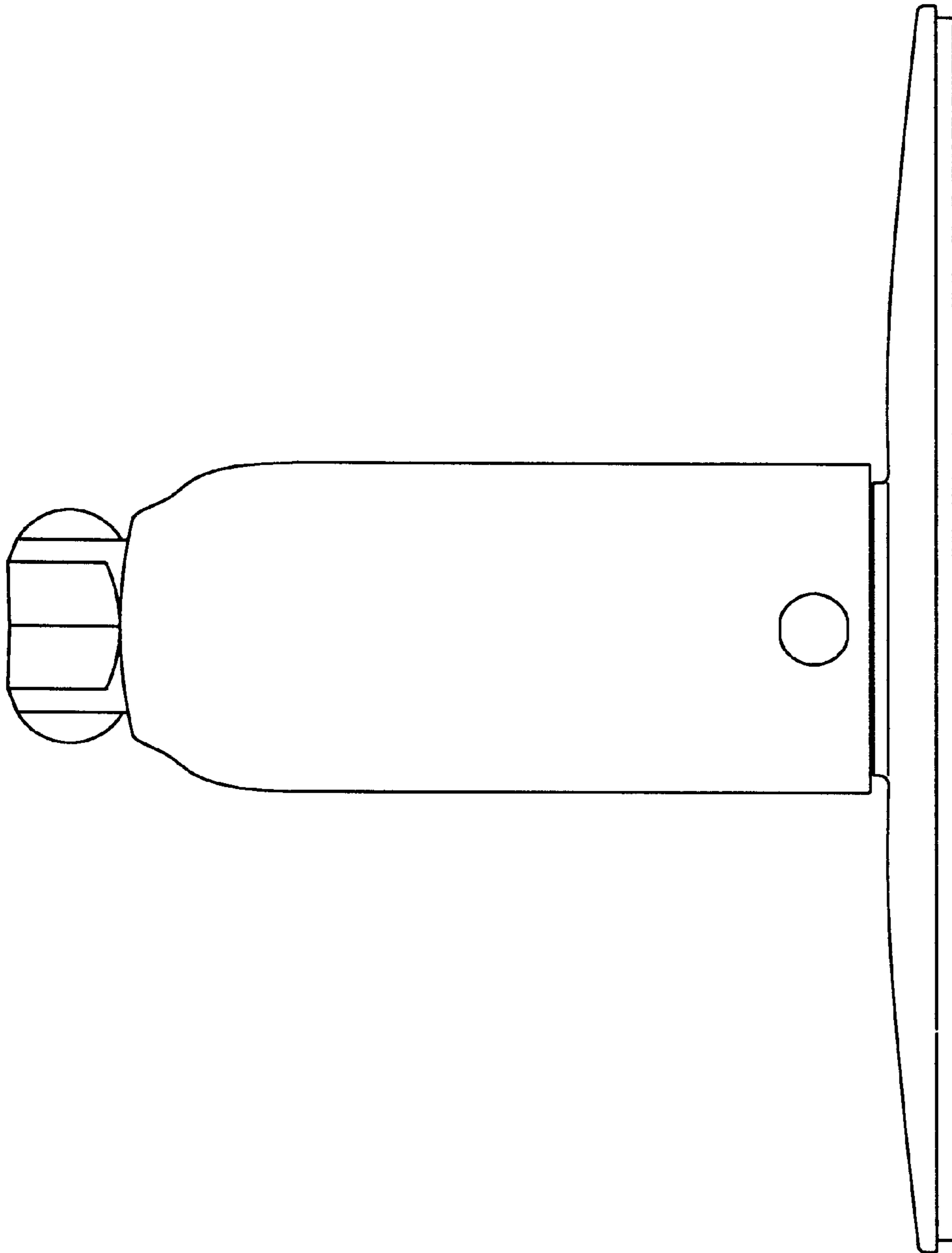

Fig.3

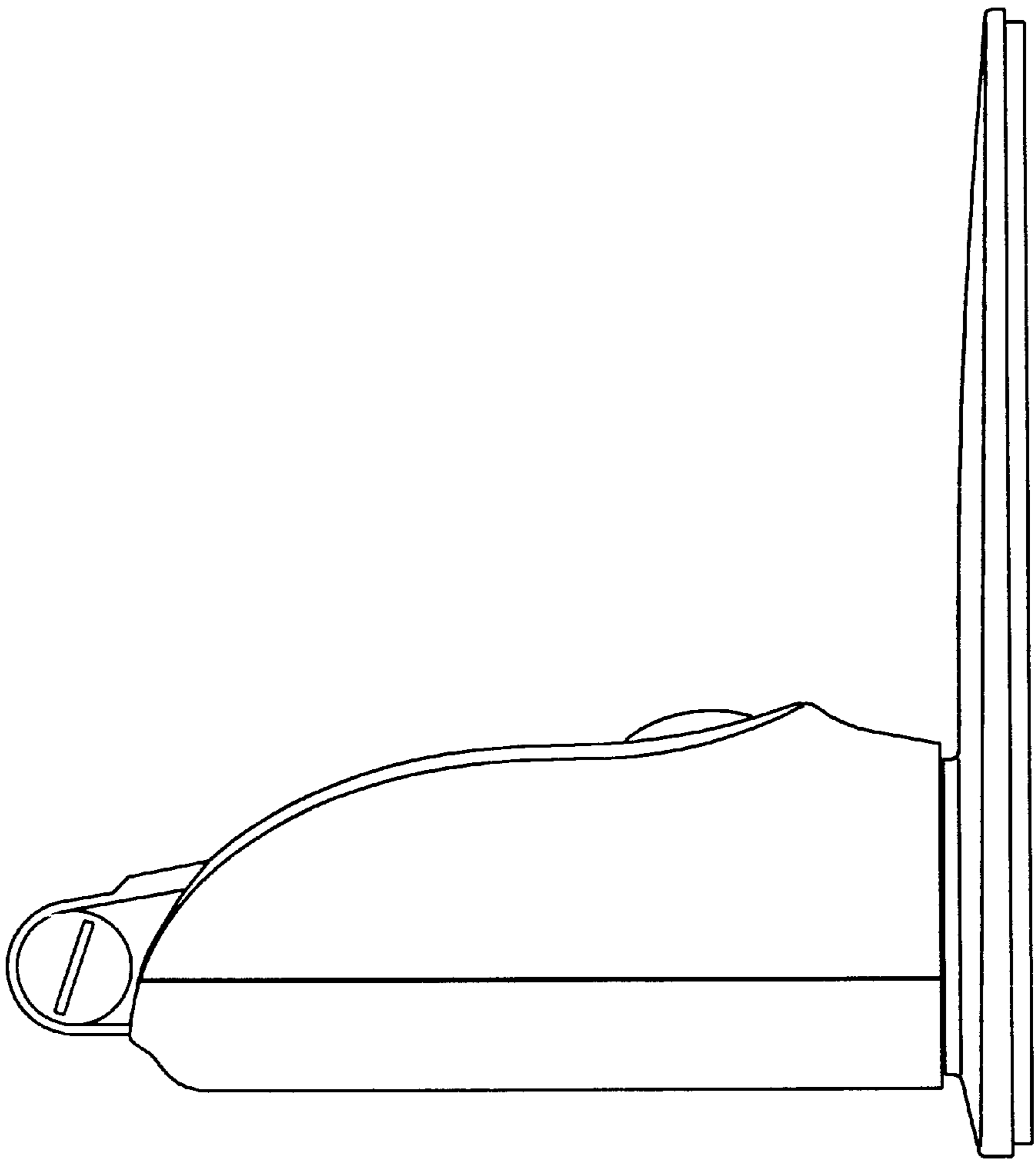

Fig.4

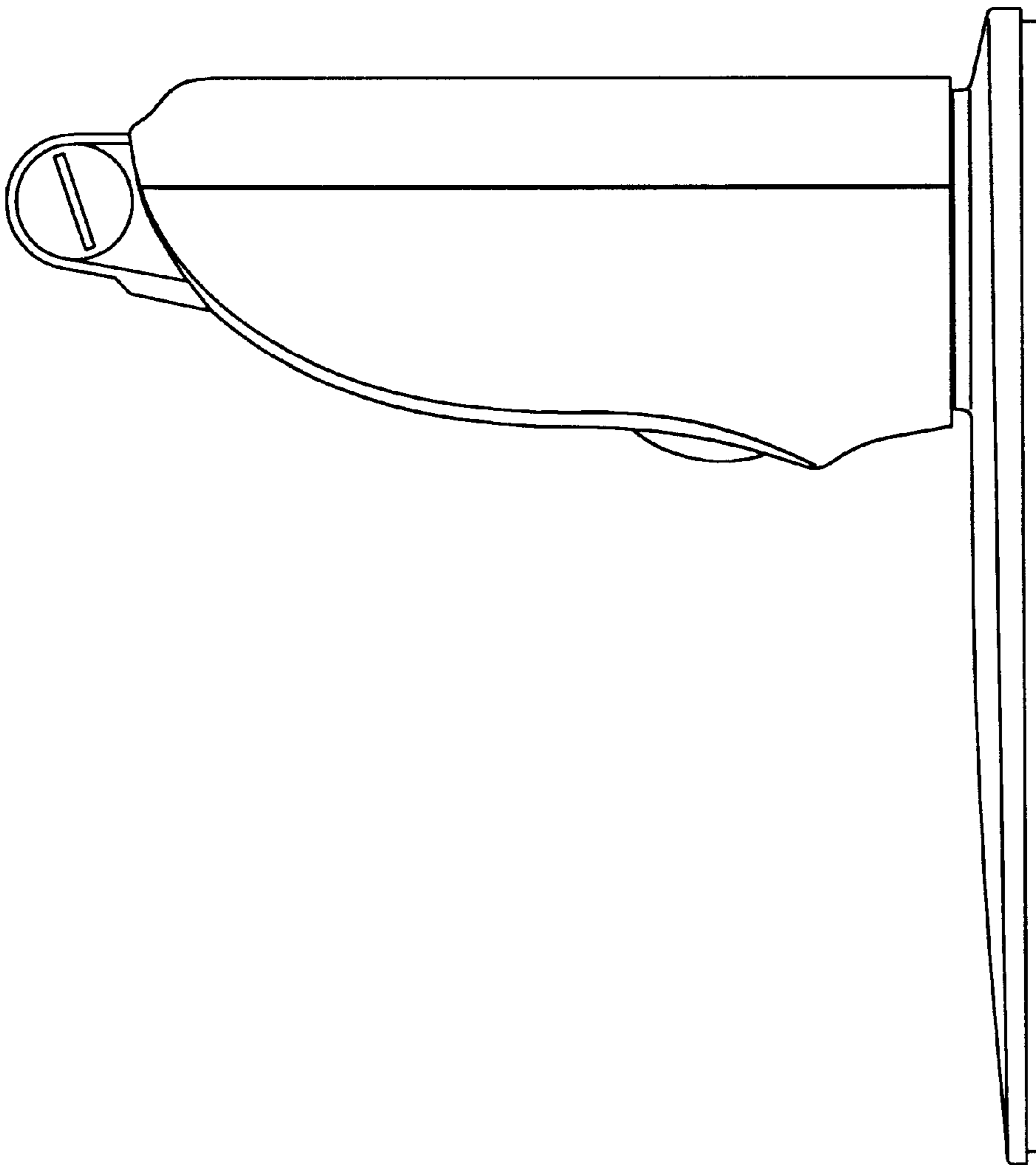

Fig.5

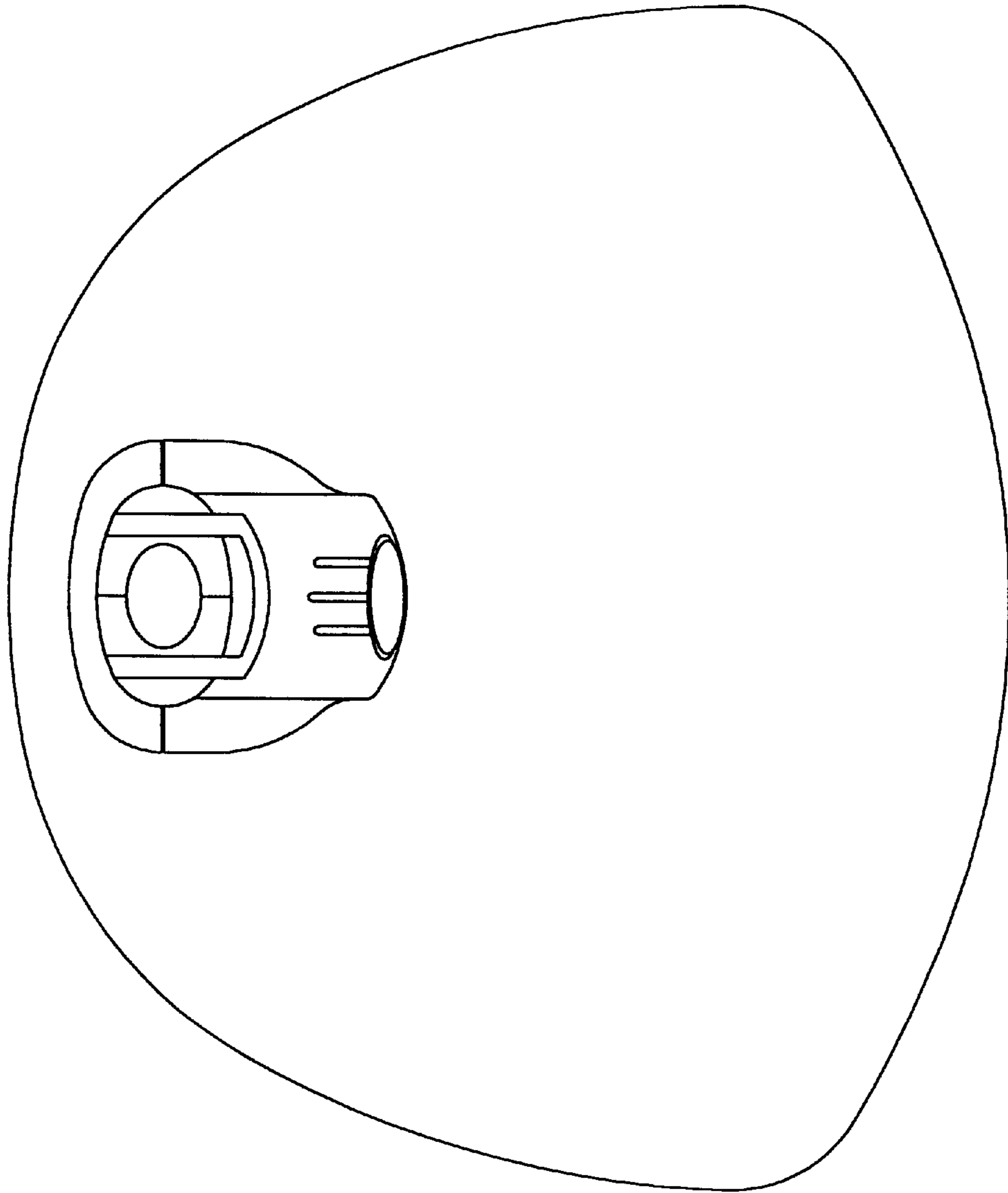

Fig.6

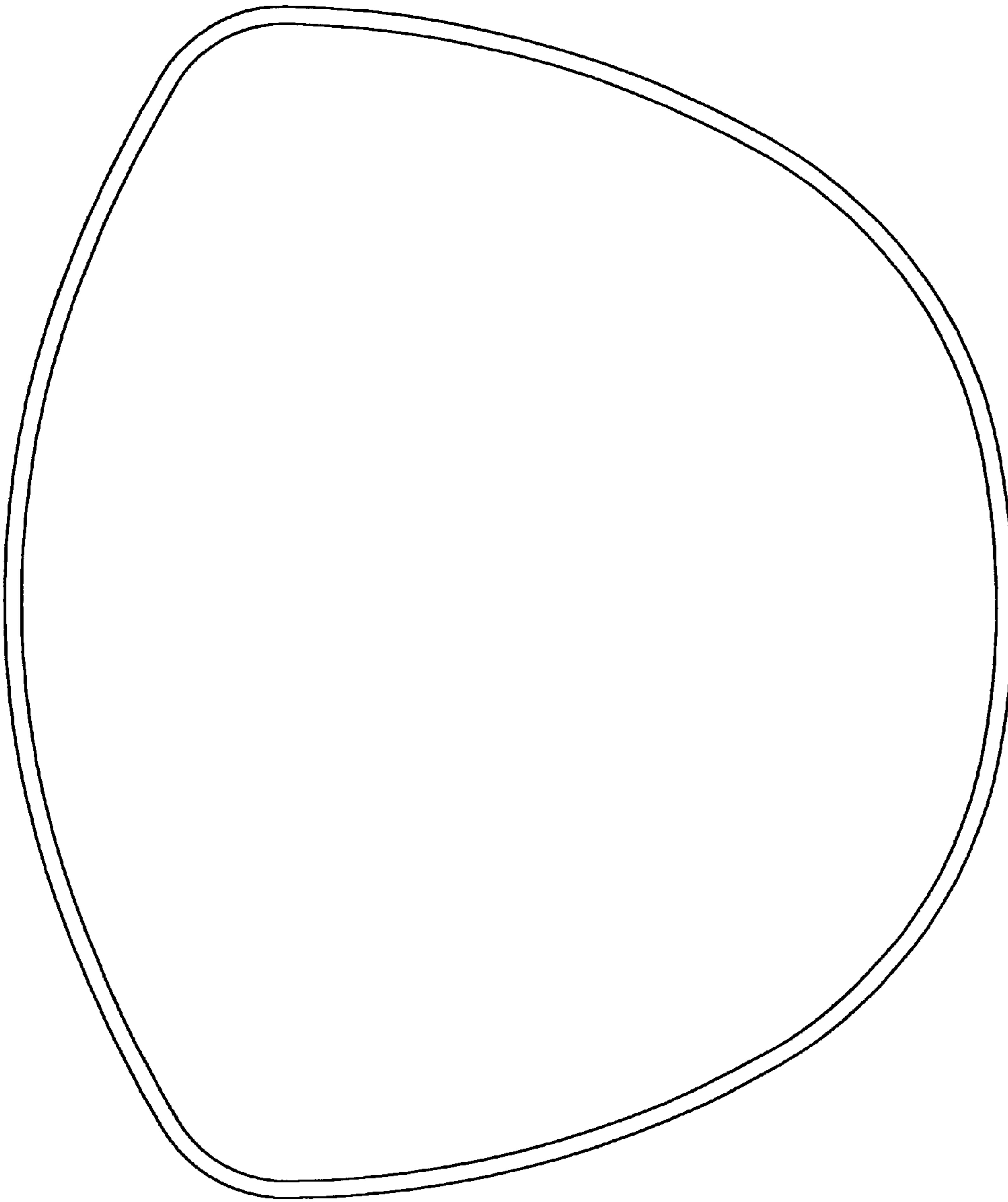

Fig.7