



US00D479599S

(12) **United States Design Patent**
Bainton

(10) **Patent No.:** **US D479,599 S**

(45) **Date of Patent:** **** Sep. 9, 2003**

(54) **MEDICAMENT DELIVERY DEVICE**

(75) **Inventor:** **Michael Cameron Bainton,**
Warwickshire (GB)

(73) **Assignee:** **DCA Design International Limited,**
Warwick (GB)

(**) **Term:** **14 Years**

(21) **Appl. No.:** **29/166,763**

(22) **Filed:** **Sep. 5, 2002**

(30) **Foreign Application Priority Data**

Mar. 8, 2002 (GB) 3002035

(51) **LOC (7) Cl.** **24-02**

(52) **U.S. Cl.** **D24/114; D19/43; D24/112;**
D24/113

(58) **Field of Search** D24/114, 112,
D24/113, 146; D19/43, 55, 51, 57; 604/218,
211, 156, 65, 198, 134, 135, 137, 136,
132, 185, 207, 208, 506, 209

(56) **References Cited**

U.S. PATENT DOCUMENTS

5,626,566	A	*	5/1997	Petersen et al.	604/208
5,957,896	A	*	9/1999	Bendek et al.	604/207
6,001,089	A	*	12/1999	Burroughs et al.	604/506
6,110,149	A	*	8/2000	Klitgaard et al.	604/211
6,193,698	B1	*	2/2001	Kirchhofer et al.	604/211
D457,186	S	*	5/2002	Moon	D19/43
D462,760	S	*	9/2002	Ahlgrim et al.	D24/114

* cited by examiner

Primary Examiner—Ian Simmons

(74) *Attorney, Agent, or Firm*—Oliff & Berridge, PLC

(57) **CLAIM**

The ornamental design for a medicament delivery device, as shown and described.

DESCRIPTION

FIG. 1 is a perspective view of a medicament delivery device with a cap on the device;
 FIG. 2 is a front view thereof;
 FIG. 3 is a rear view thereof;
 FIG. 4 is a left-side view thereof;
 FIG. 5 is a right-side view thereof;
 FIG. 6 is a top view thereof;
 FIG. 7 is a bottom view thereof;
 FIG. 8 is another perspective view thereof with the cap removed from the device;
 FIG. 9 is a front view thereof with the cap removed from the device;
 FIG. 10 is a rear view thereof with the cap removed from the device;
 FIG. 11 is a left-side view thereof with a cap removed from the device;
 FIG. 12 is a right-side thereof with a cap removed from the device;
 FIG. 13 is a top view thereof with a cap removed from the device; and,
 FIG. 14 is a bottom view thereof with a cap removed from the device.

1 Claim, 5 Drawing Sheets

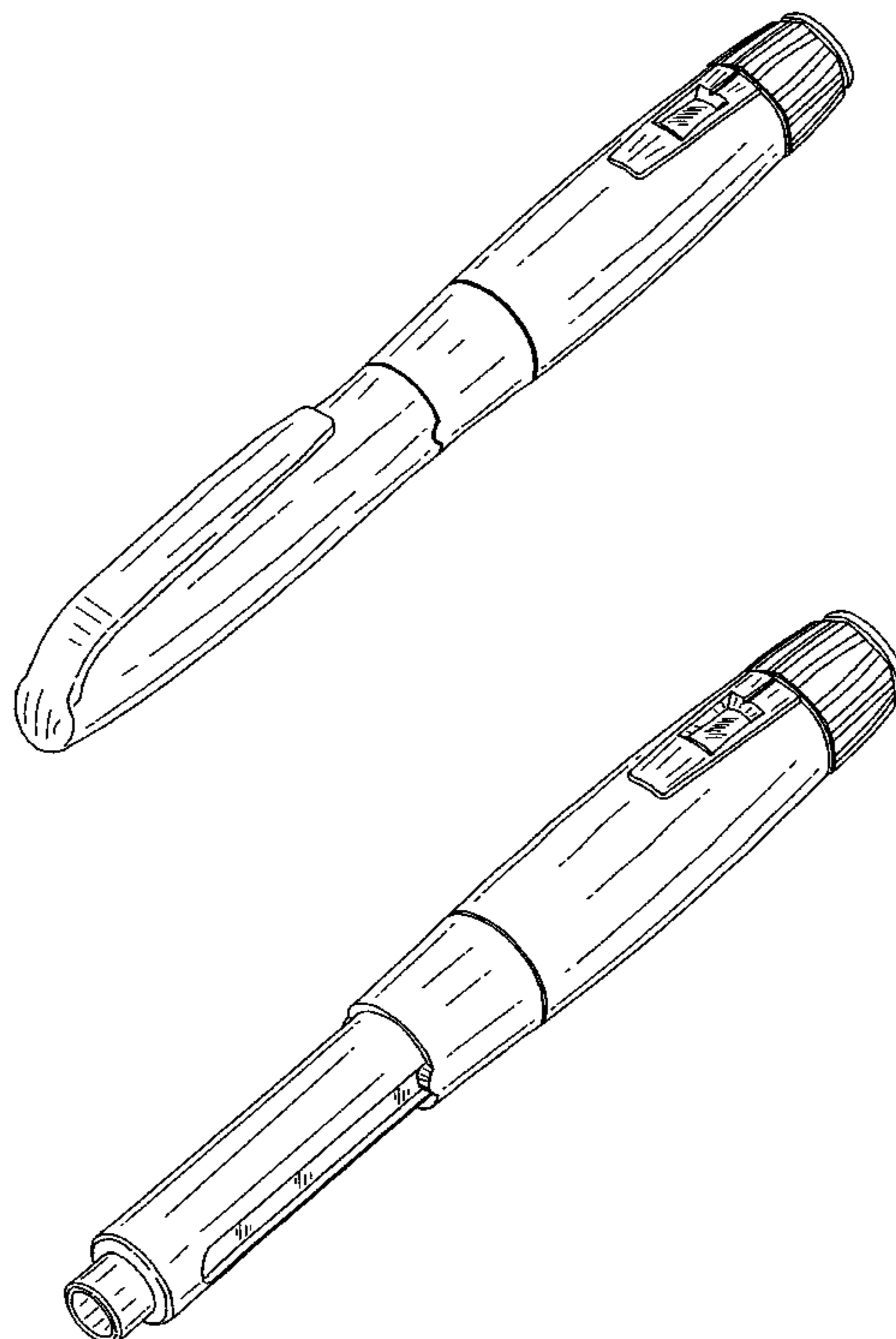

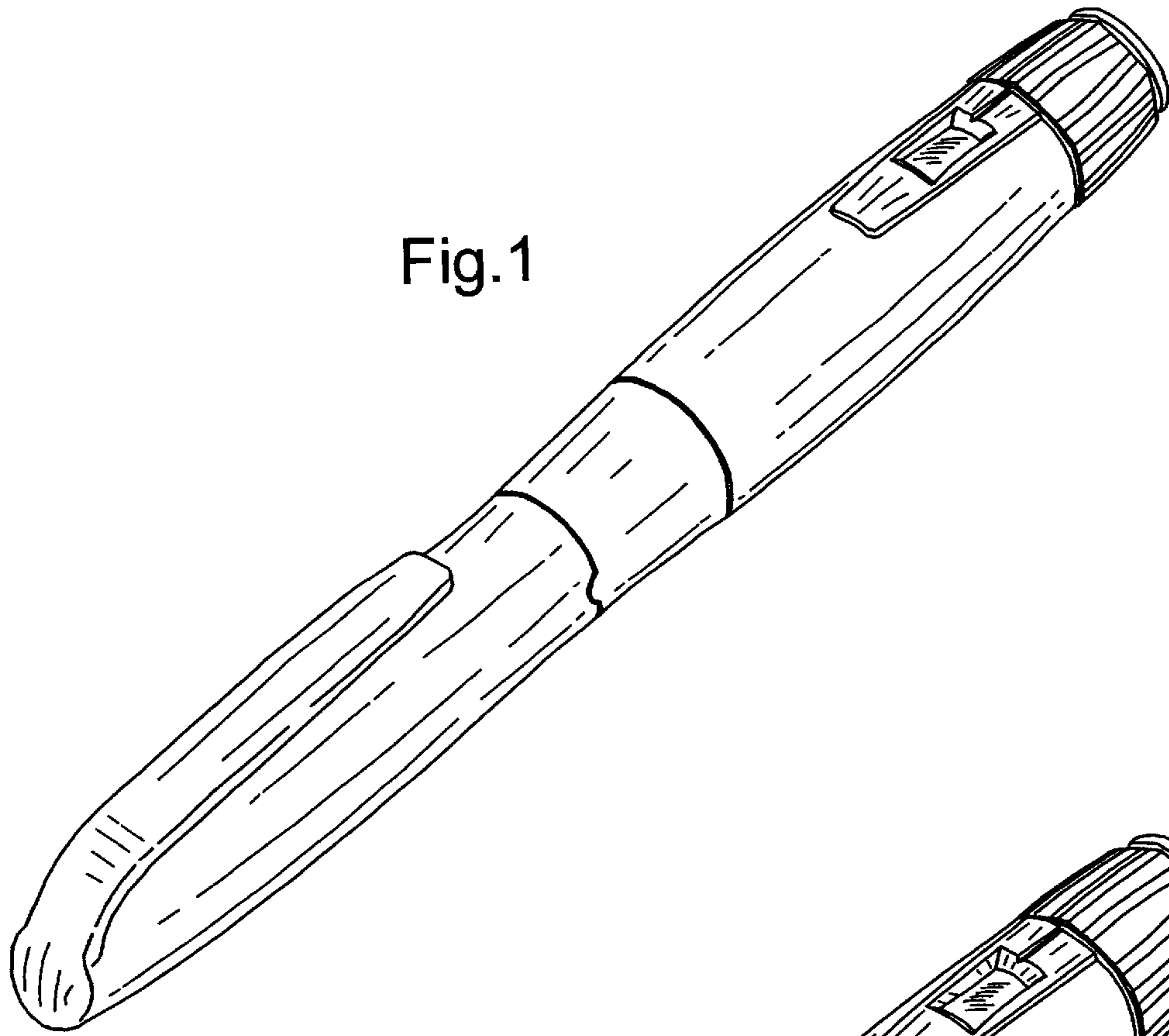

Fig.1

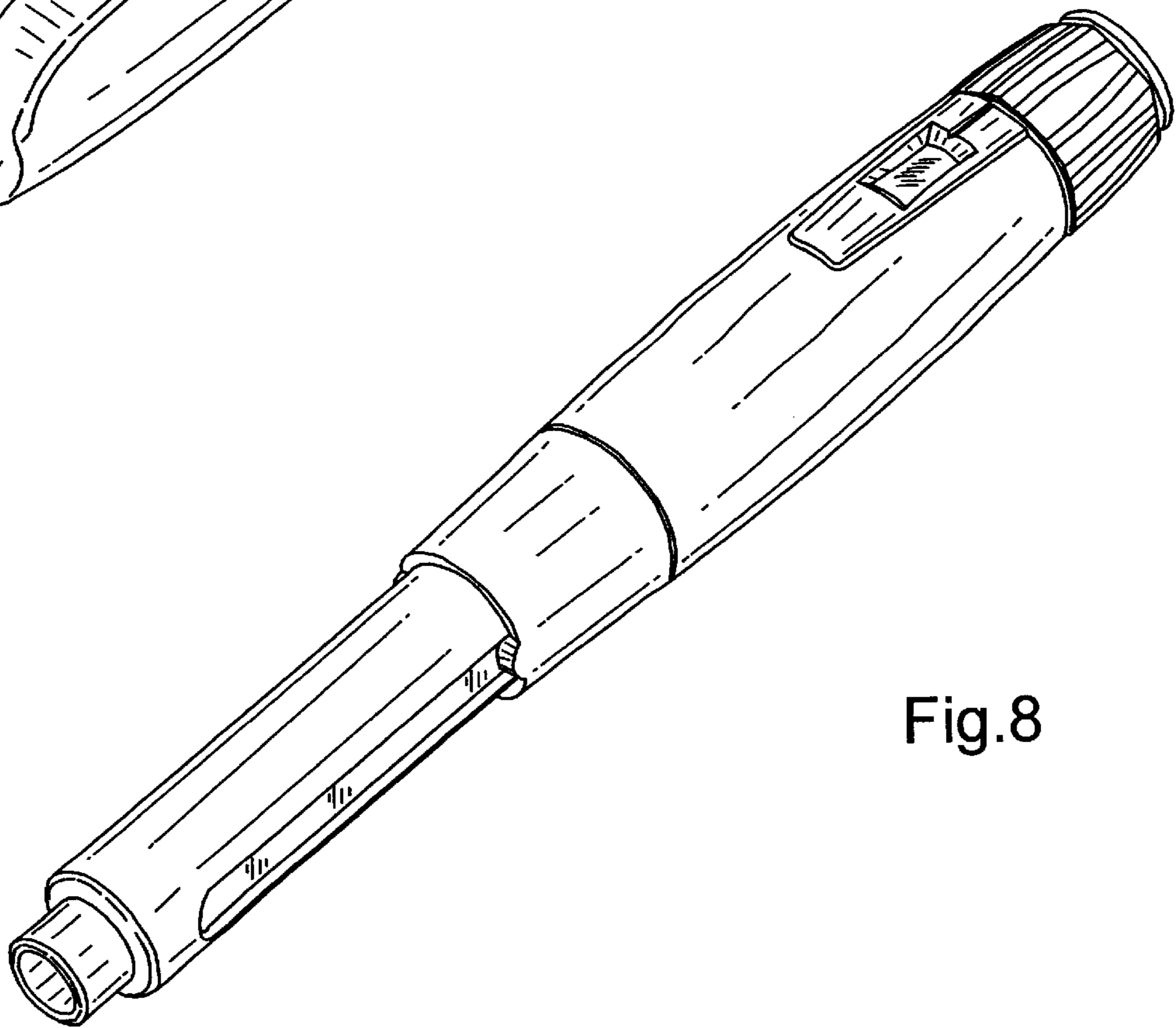

Fig.8

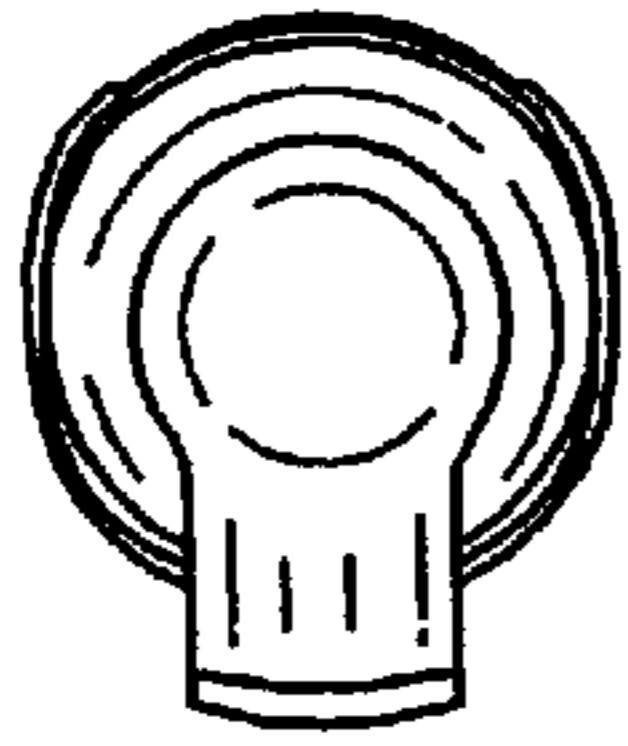

Fig.6

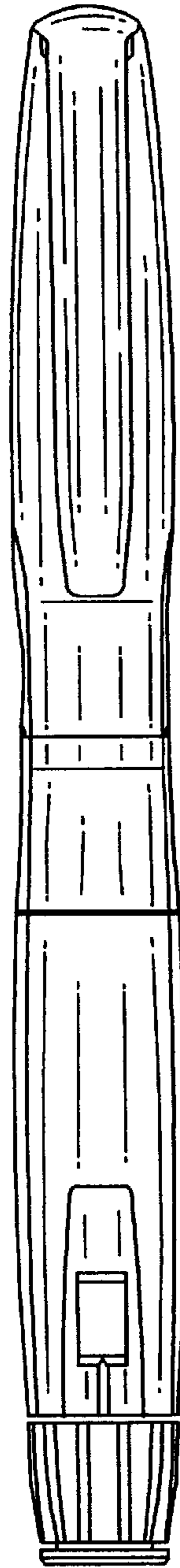

Fig.2

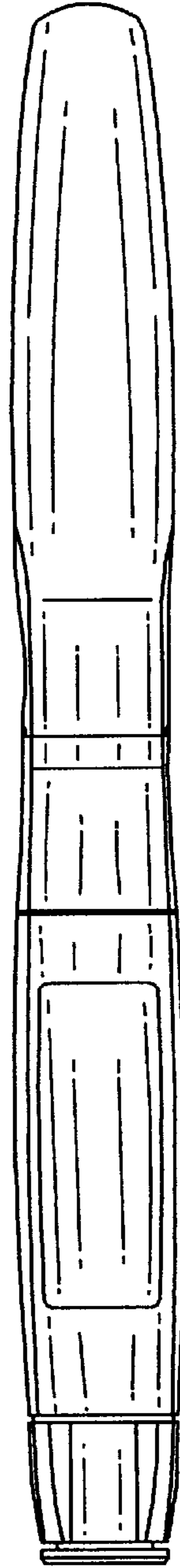

Fig.3

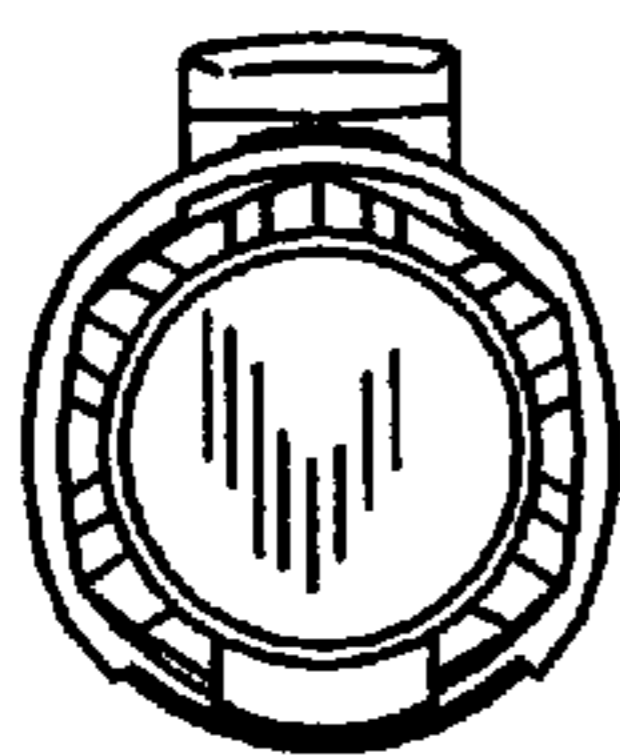

Fig.7

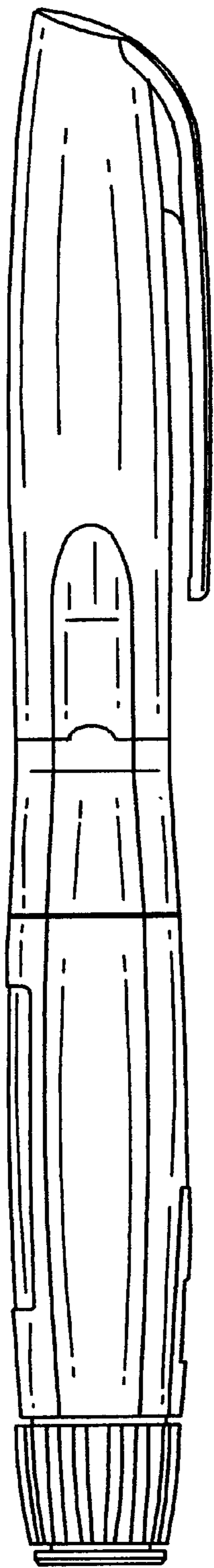

Fig.4

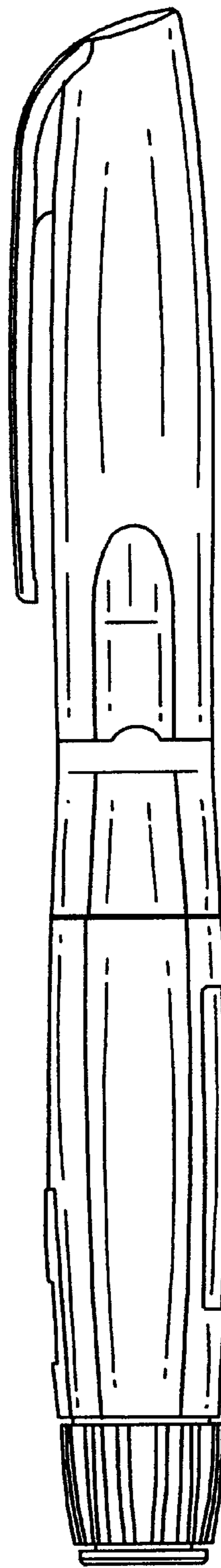

Fig.5

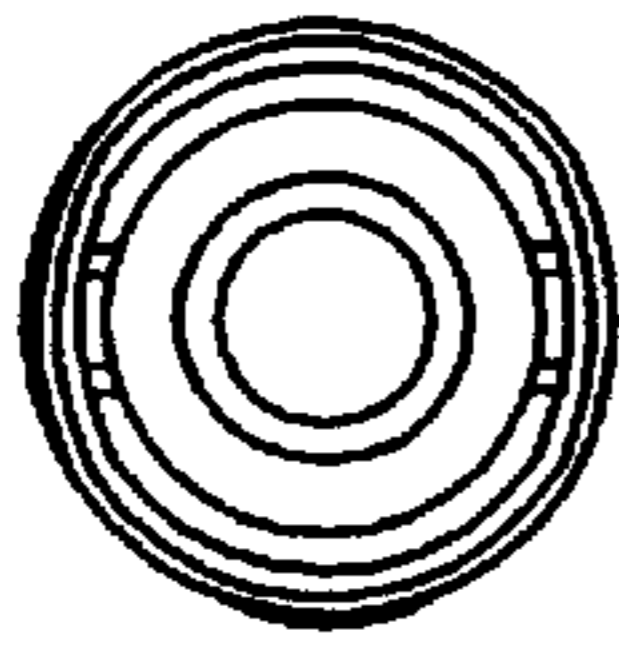

Fig.13



Fig.14

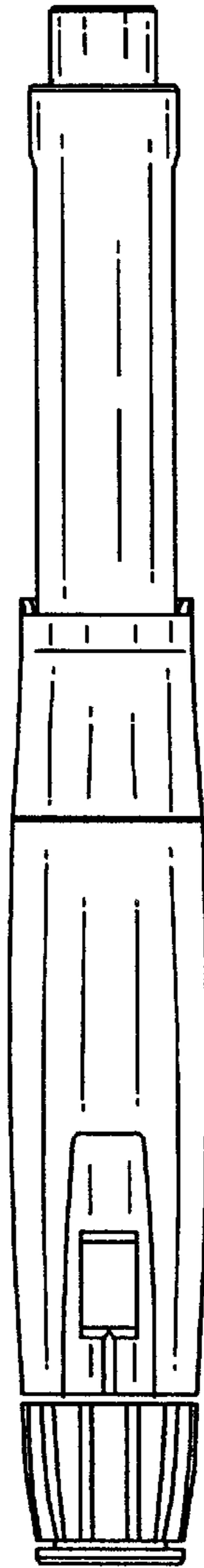

Fig.9

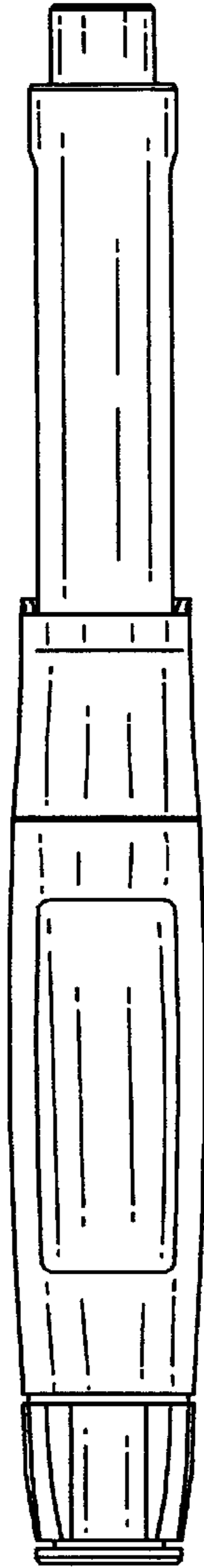

Fig.10

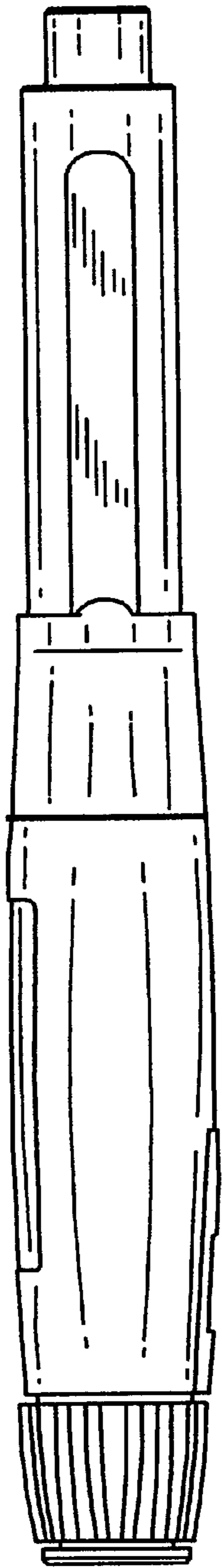

Fig. 11

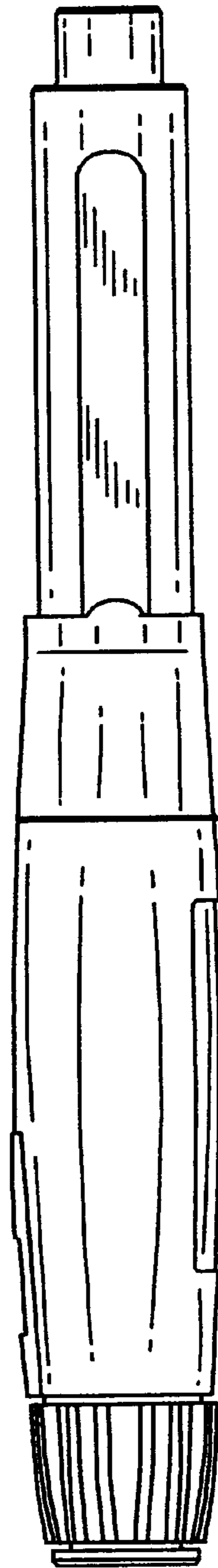

Fig. 12