



US00D479593S

(12) **United States Design Patent**
Fok

(10) **Patent No.:** **US D479,593 S**

(45) **Date of Patent:** **** Sep. 9, 2003**

(54) **ELECTRIC FAN**

D389,567 S * 1/1998 Gudfin D23/378
D464,723 S * 10/2002 Fok D23/378

(76) Inventor: **Su Tim Fok**, 175 Rua de Xangai, 15
Andar H, Edif da Associacao Comercial
de Macau (MO)

* cited by examiner

(**) Term: **14 Years**

Primary Examiner—Lisa Lichtenstein

(74) *Attorney, Agent, or Firm*—Merchant & Gould, P.C.

(21) Appl. No.: **29/163,971**

(57) **CLAIM**

(22) Filed: **Jul. 15, 2002**

The ornamental design for electric fan, as shown and described.

(30) **Foreign Application Priority Data**

Jan. 21, 2002 (CN) 02 3 00364

DESCRIPTION

(51) **LOC (7) Cl.** **23-04**

FIG. 1 is a front elevational view of an electric fan in accordance with the principles of my invention;

(52) **U.S. Cl.** **D23/378**

FIG. 2 is a left side elevational view thereof;

(58) **Field of Search** D23/378, 370,
D23/335, 337, 332, 381; 392/365, 367;
415/53.1-53.3; 416/244 R, 247 R

FIG. 3 is a bottom plan view thereof;

FIG. 4 is a top plan view thereof;

FIG. 5 is a right side elevational view thereof;

FIG. 6 is a rear elevational view thereof; and,

FIG. 7 is a perspective view thereof.

(56) **References Cited**

U.S. PATENT DOCUMENTS

D322,669 S * 12/1991 Yamamoto et al. D23/378

1 Claim, 3 Drawing Sheets

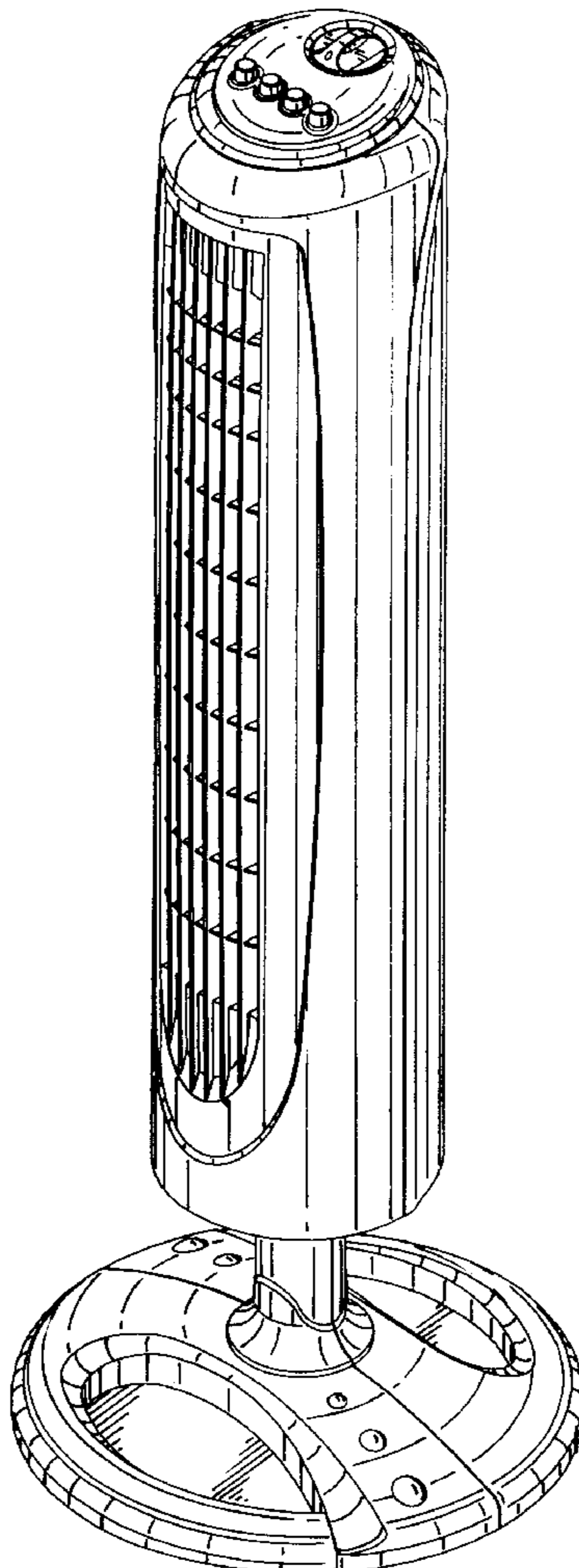

FIG. 1

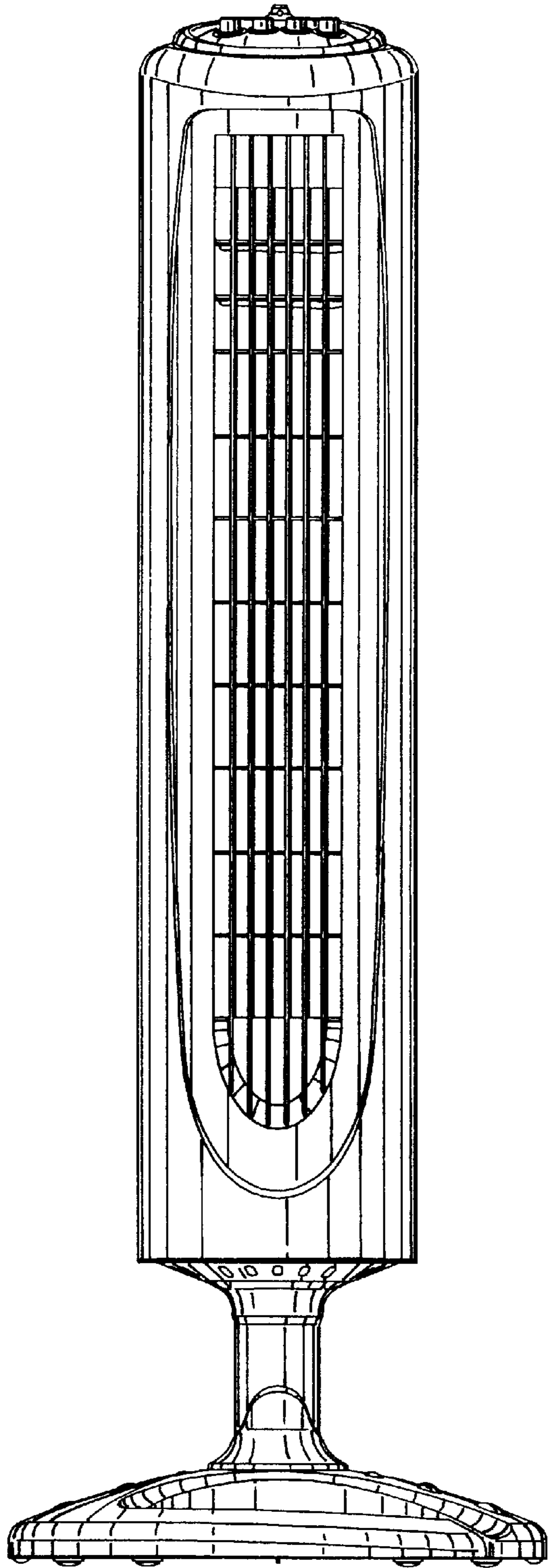

FIG. 2

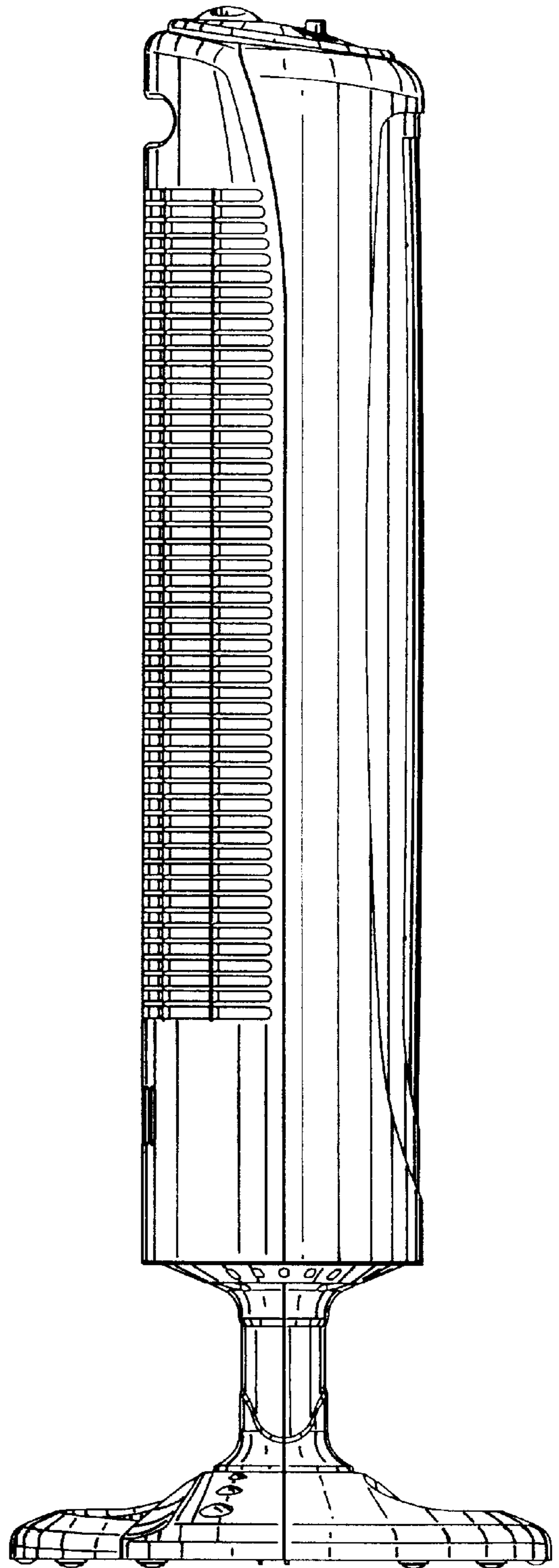

FIG. 3

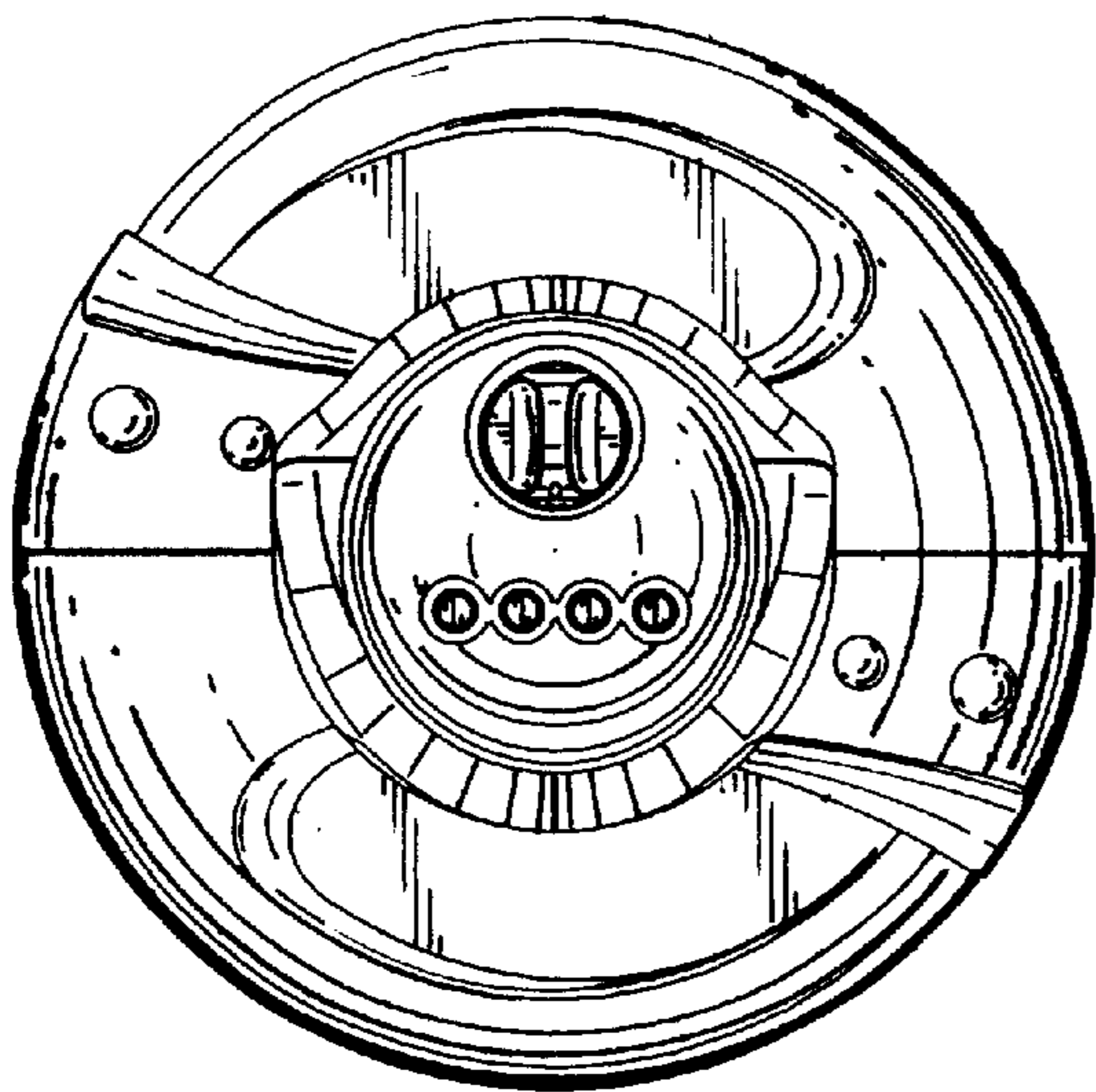
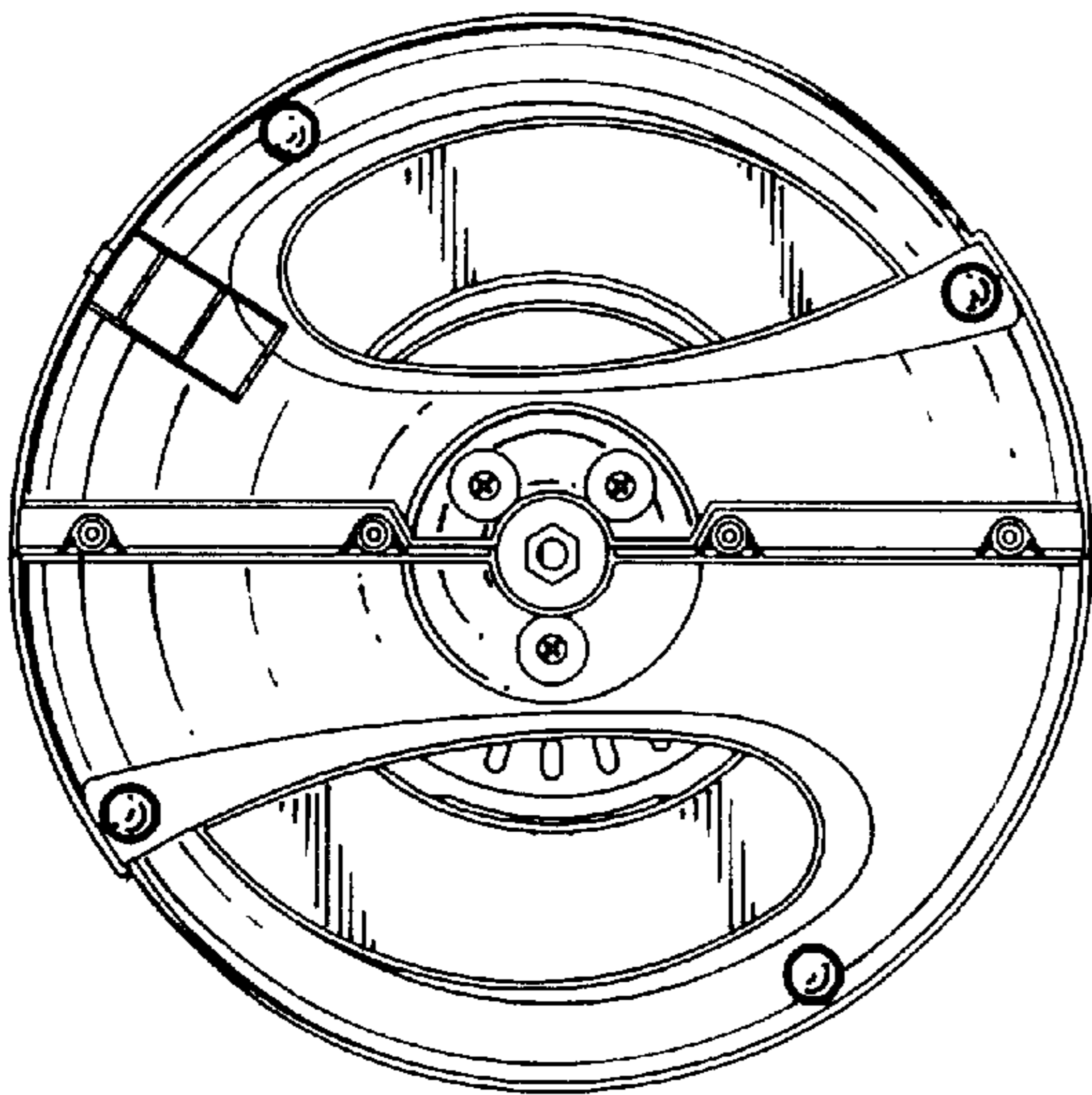

FIG. 4

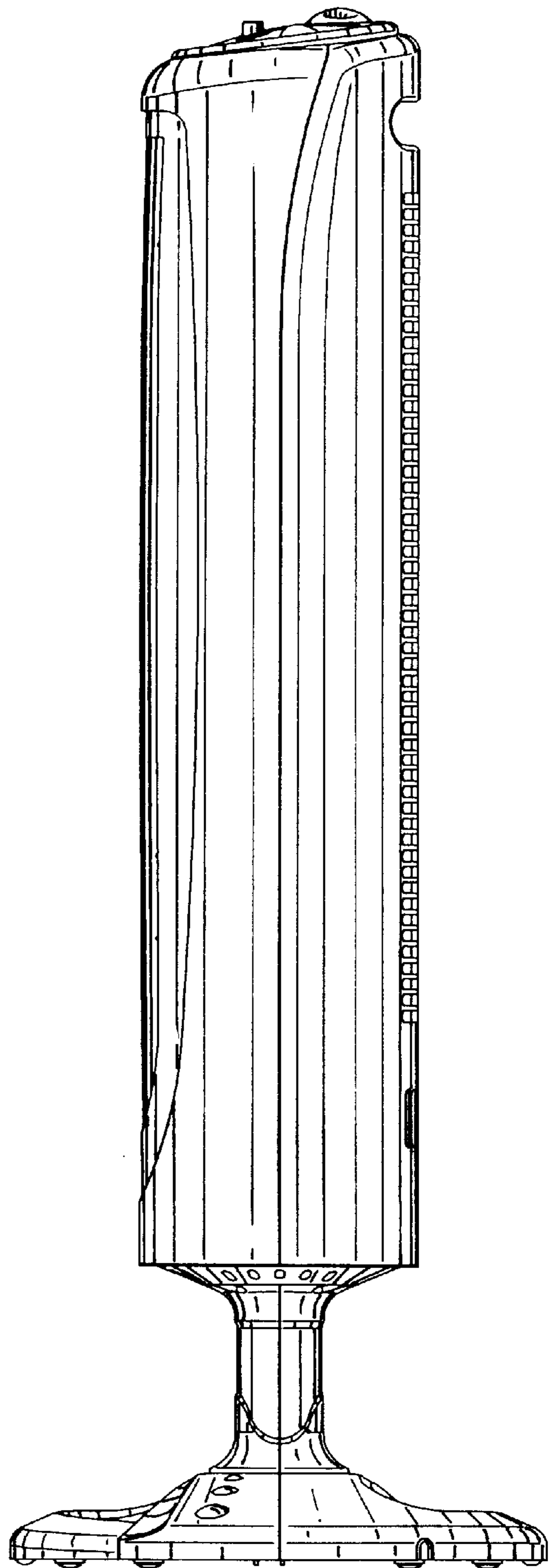

FIG. 5

FIG. 6

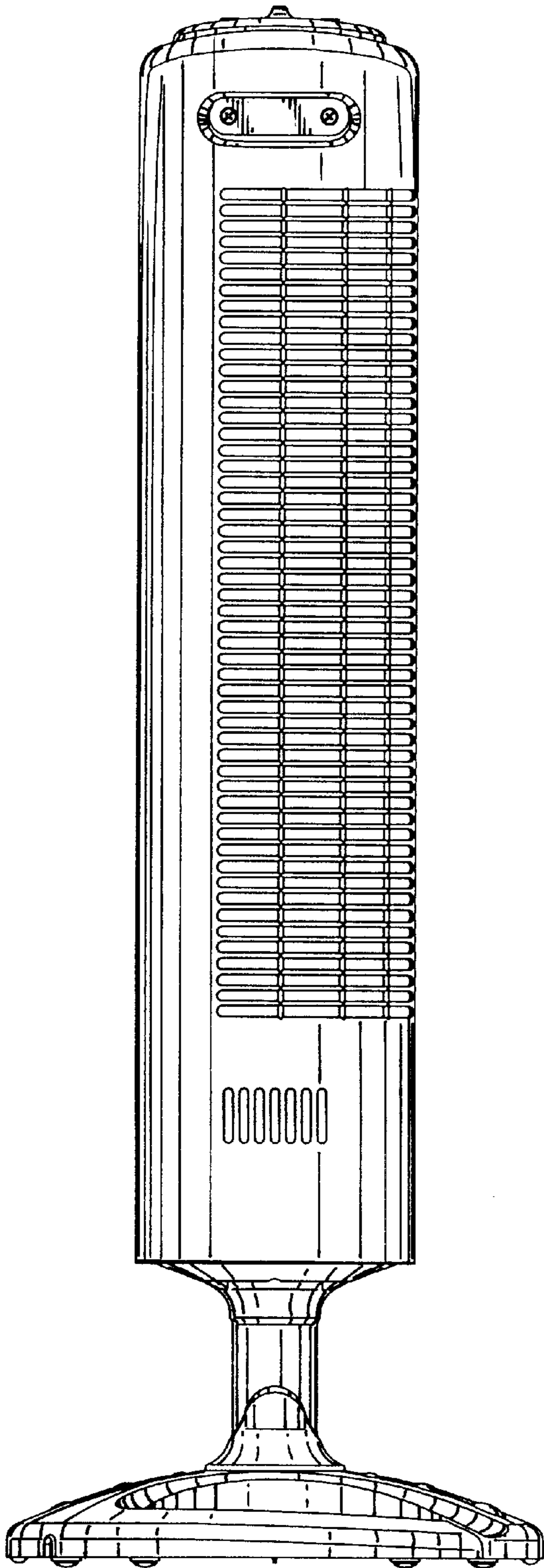

FIG. 7

