



US00D479370S

(12) **United States Design Patent**
Neves

(10) **Patent No.: US D479,370 S**

(45) **Date of Patent: ** *Sep. 2, 2003**

(54) **HOUSE SHAPED LITTER BOX WITH
REMOVABLE PEAK ROOF**

(76) Inventor: **Susan Diane Neves**, P.O. Box 2631,
Rocklin, CA (US) 95677

(*) Notice: This patent is subject to a terminal dis-
claimer.

(**) Term: **14 Years**

(21) Appl. No.: **29/148,582**

(22) Filed: **Sep. 21, 2001**

(51) **LOC (7) Cl.** **30-99**

(52) **U.S. Cl.** **D30/161**

(58) **Field of Search** D30/108-109,
D30/112-119, 158-160, 161, 110-111;
119/28.5, 436, 445, 452-453, 455-456,
464, 467-468, 474-475, 497, 482, 484-485,
489, 498, 500, 503, 537, 165-170

(56) **References Cited**

U.S. PATENT DOCUMENTS

D134,429 S	*	11/1942	Steelman	D30/108
D248,879 S	*	8/1978	Hill	D30/112
4,732,111 A	*	3/1988	Runion	119/165
D314,453 S	*	2/1991	Dewing	D30/108
D319,115 S	*	8/1991	White	D30/112
D327,143 S	*	6/1992	Dickinson	D30/108
5,121,710 A	*	6/1992	Gonzalez	119/498
D335,589 S	*	5/1993	Benedict	D30/161
D349,366 S	*	8/1994	Kuhn et al.	D30/108
D351,637 S	*	10/1994	Neidig	D30/108
D353,028 S	*	11/1994	Boscato	D30/108
D356,253 S	*	3/1995	Bacchetti et al.	D30/108
D359,588 S	*	6/1995	Brazis	D30/108
D361,647 S	*	8/1995	Thomas et al.	D30/108
D366,541 S	*	1/1996	Bradburn et al.	D30/112
5,551,371 A	*	9/1996	Markey et al.	119/499
5,582,135 A	*	12/1996	Bellows	119/168
D377,549 S	*	1/1997	Long et al.	D30/161
D386,830 S	*	11/1997	Mele	D30/108
D388,910 S	*	1/1998	Willinger et al.	D30/108

5,865,140 A	*	2/1999	McGivern	119/168
D420,470 S	*	2/2000	Kolozsvari et al.	D30/108
D425,674 S	*	5/2000	Dykens	D30/112
D432,593 S	*	10/2000	Naughton	D30/110
D443,731 S	*	6/2001	Lee	D30/108
D443,732 S	*	6/2001	Gelhar	D30/108

* cited by examiner

Primary Examiner—Cathy Anne MacCormac
(74) *Attorney, Agent, or Firm*—Mark C. Jacobs

(57) **CLAIM**

The ornamental design for a house shaped litter box with removable peak roof, as shown and described.

DESCRIPTION

FIG. 1 is a perspective view of the first embodiment with the roof;

FIG. 2 is a front elevational view of the first and third embodiment;

FIG. 3 is a side view of the first embodiment;

FIG. 4 is a top plan view of all embodiments;

FIG. 5 is a rear view of all embodiments;

FIG. 6 is a bottom plan view of all embodiments;

FIG. 7 is a front view of the removed roof;

FIG. 8 is a perspective bottom inside view of the removed roof;

FIG. 9 is an underside plan view of the roof;

FIG. 10 is a left perspective view of the first embodiment without the roof, the right perspective view being a mirror image thereof;

FIG. 11 is the top plan view of the first and third embodiments with the roof removed;

FIG. 12 is a right side front perspective view of the second embodiment;

FIG. 13 is an elevational view of the left right side of the third embodiment;

FIG. 14 is a left side elevational view of the second embodiment; and,

FIG. 15 is a top plan view of the second embodiment with the roof removed.

1 Claim, 5 Drawing Sheets

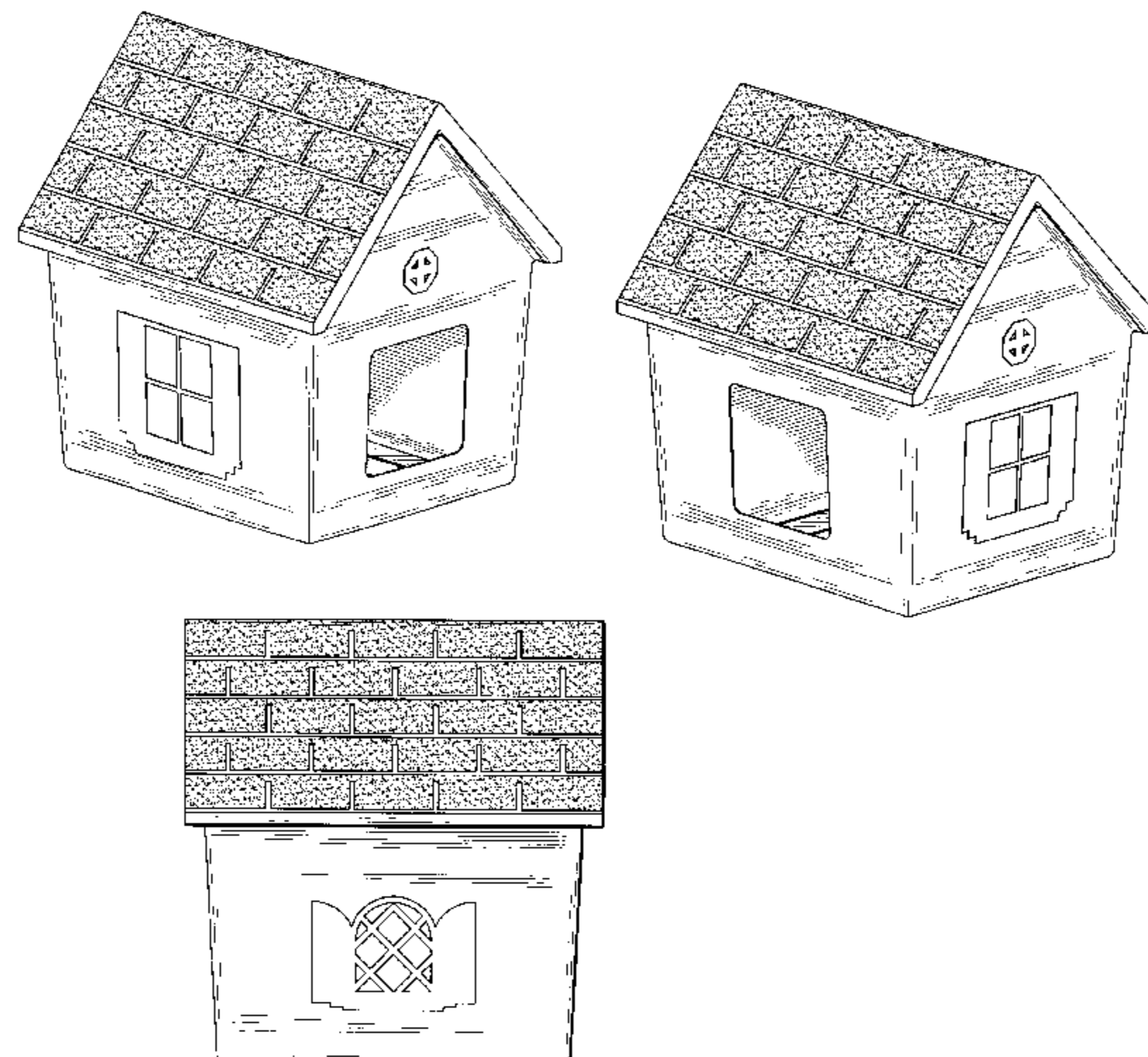

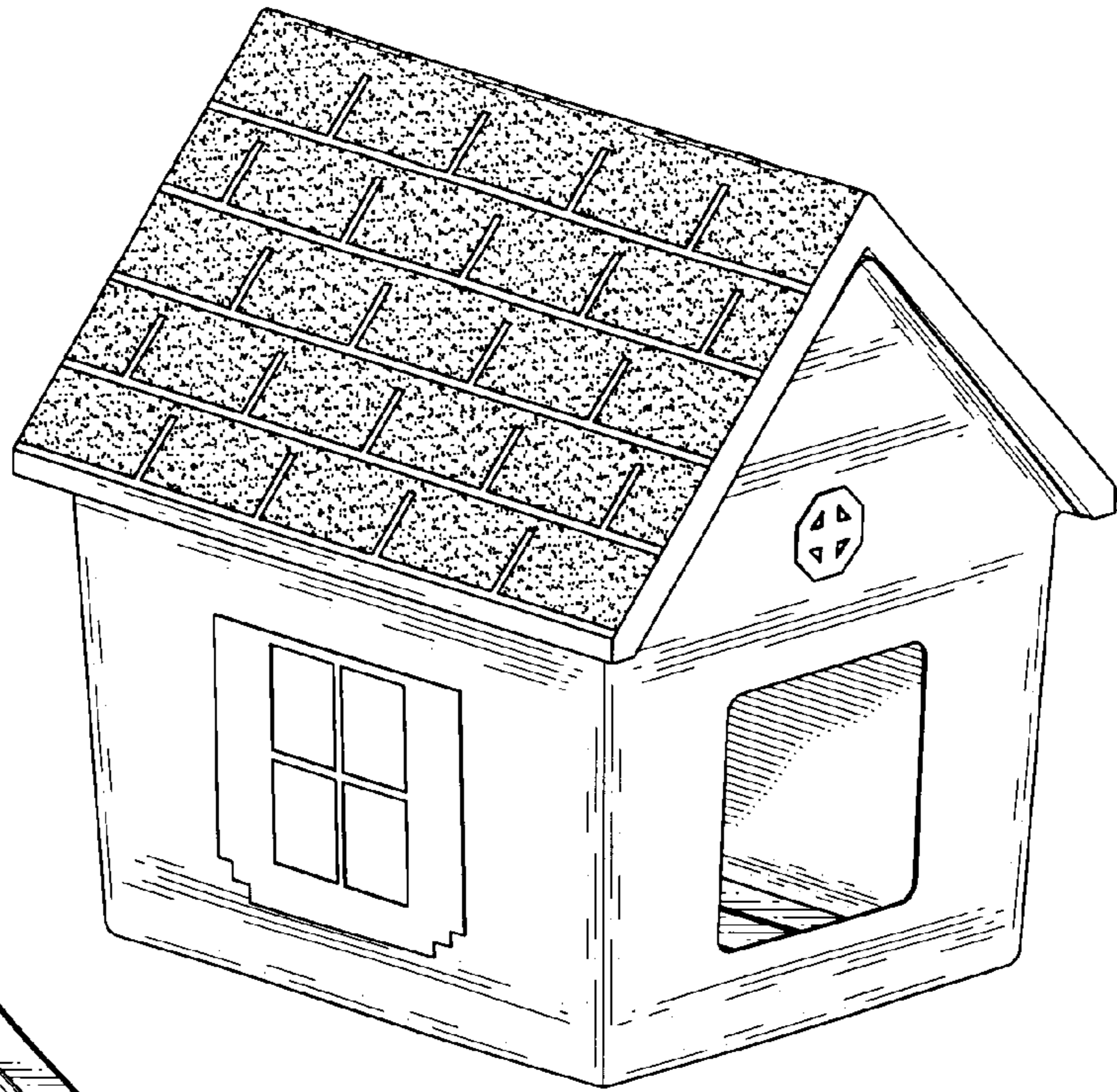

Fig. 1

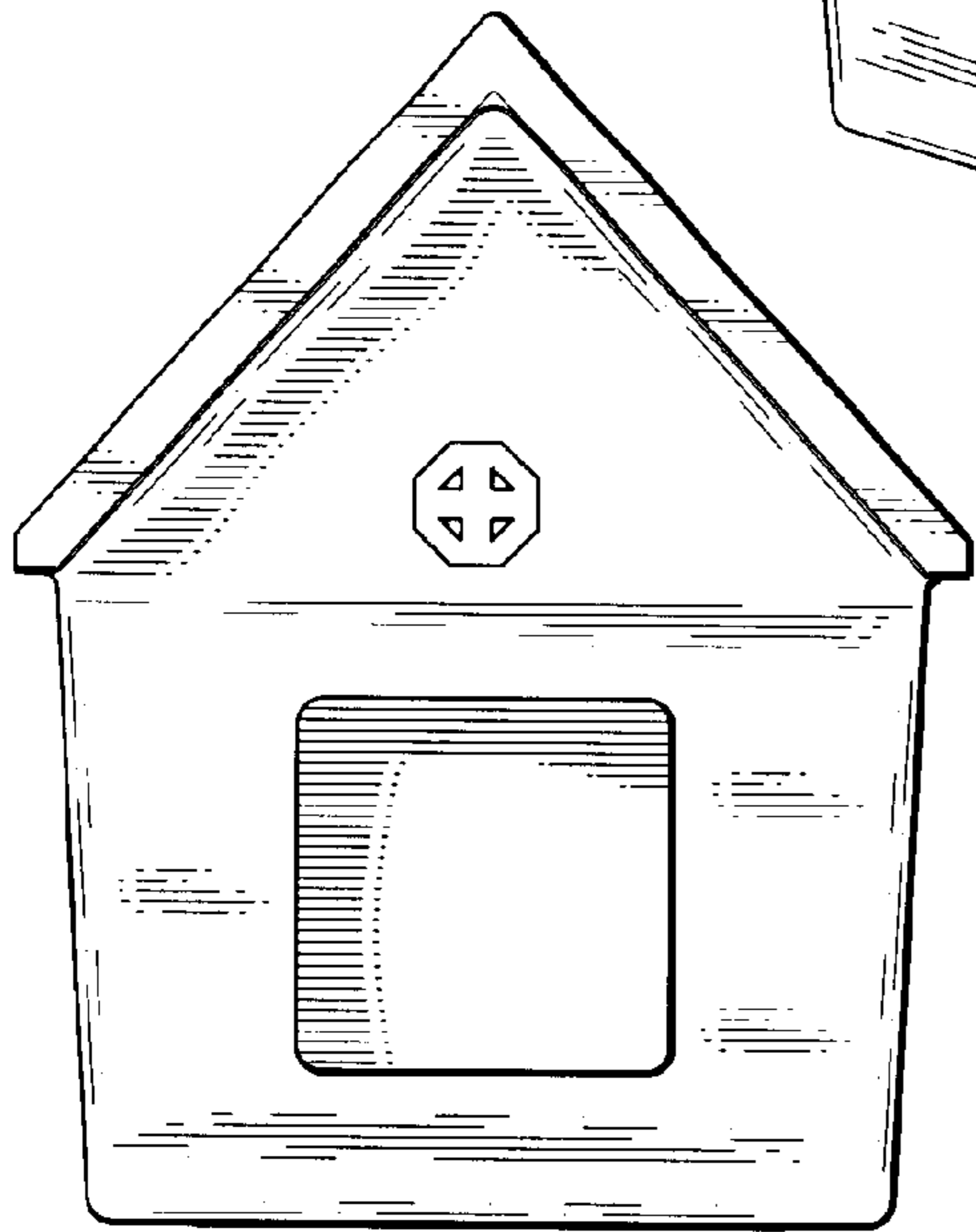

Fig. 2

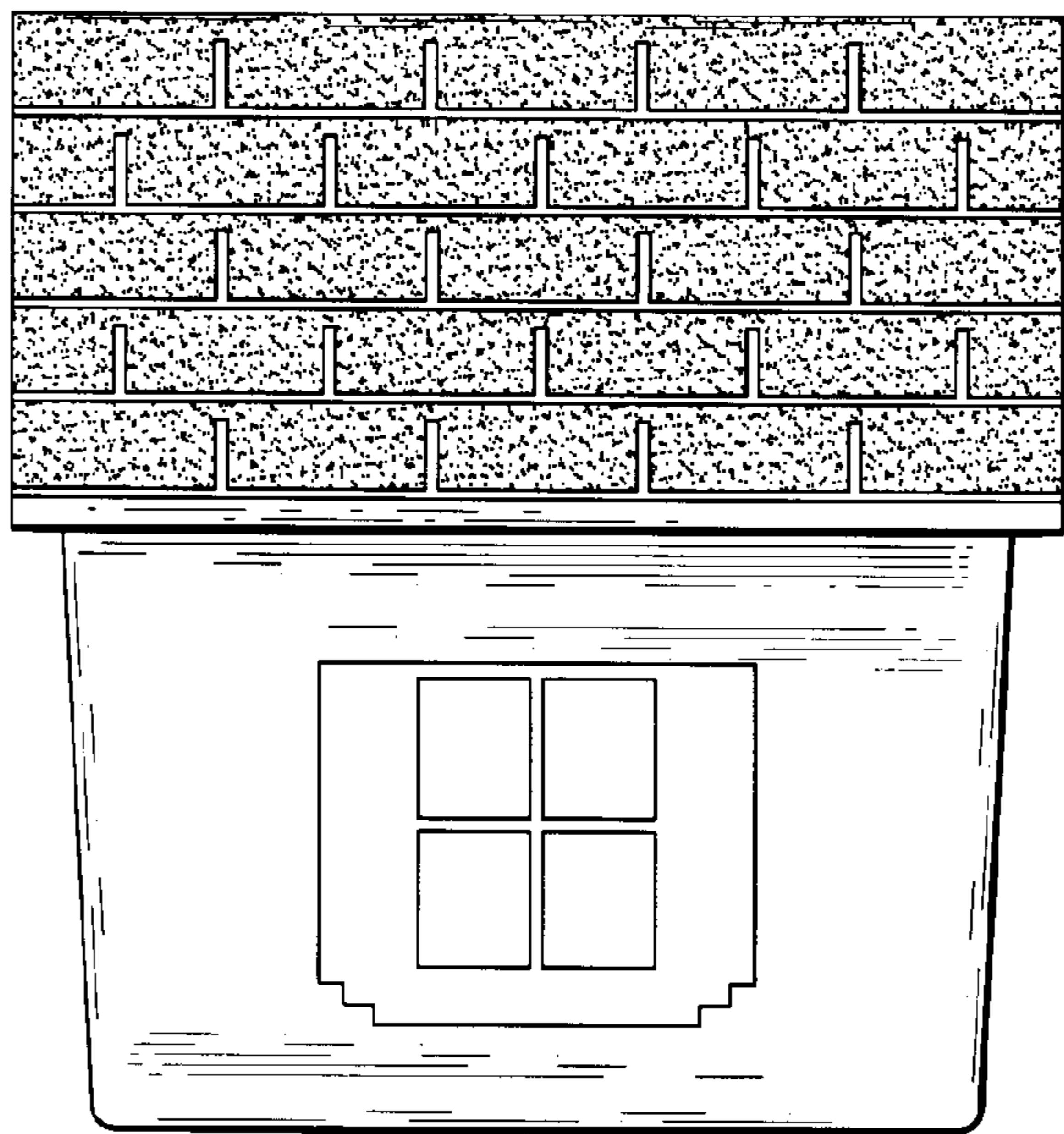

Fig. 3

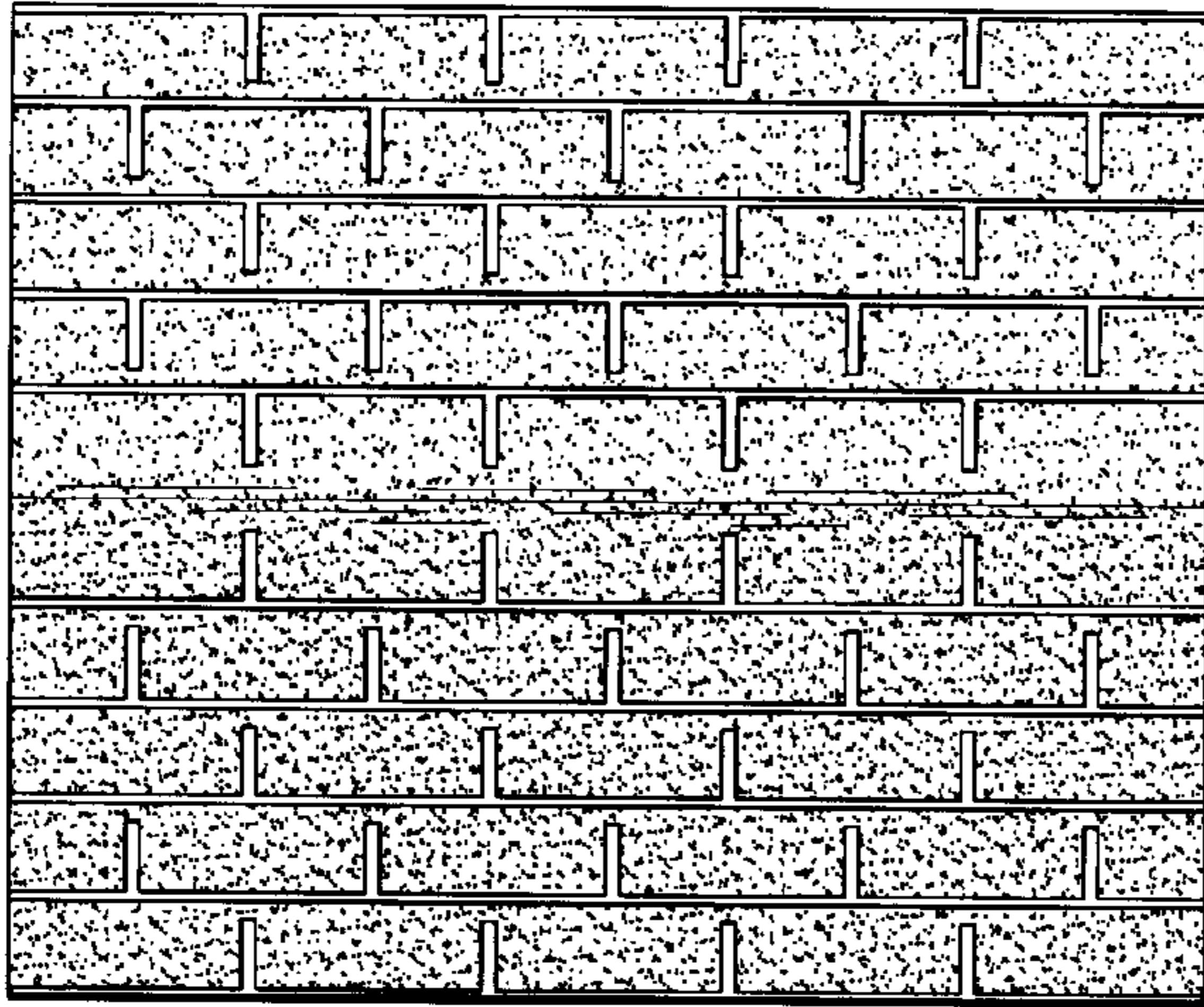

Fig. 4

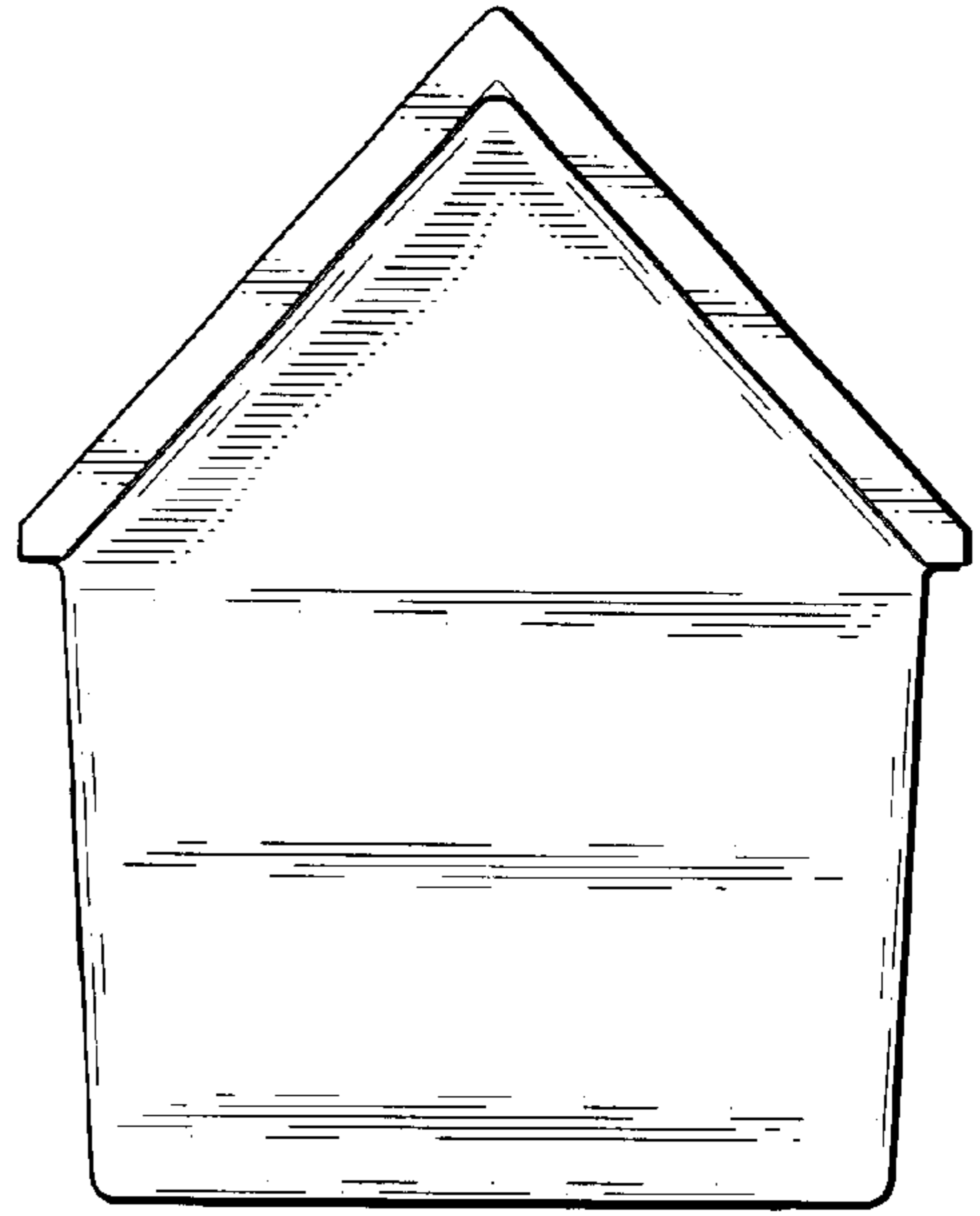

Fig. 5

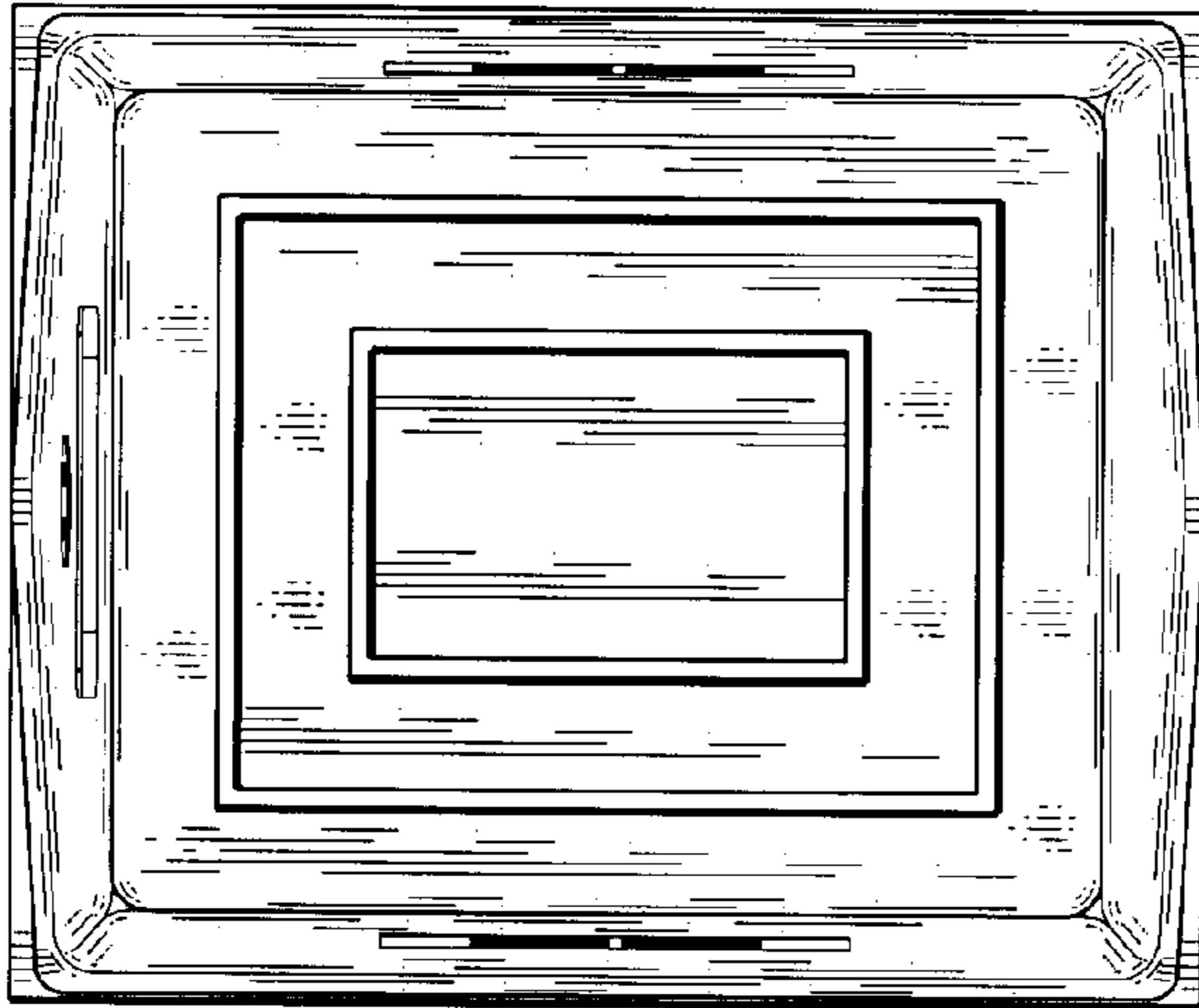

Fig. 6

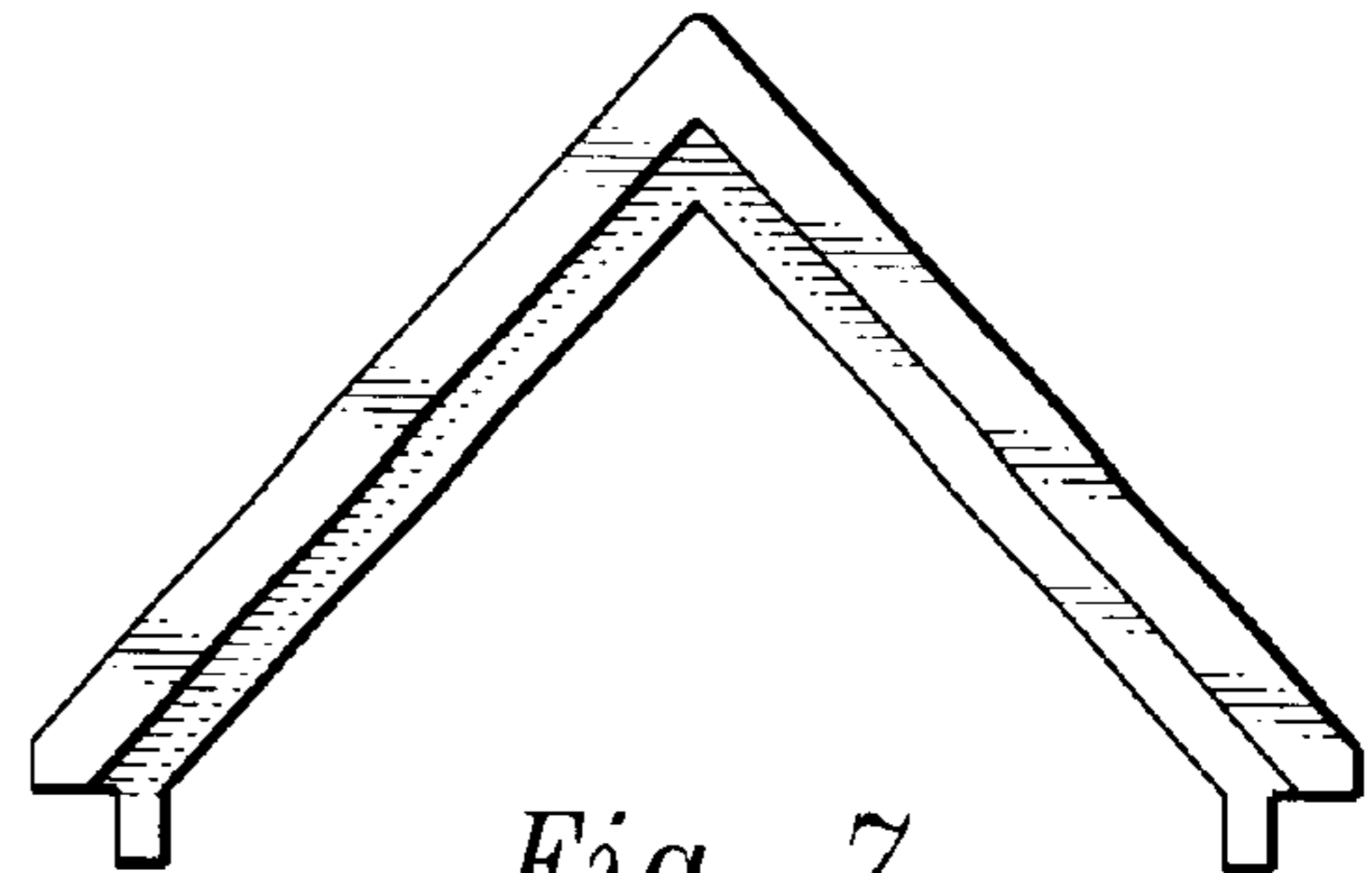

Fig. 7

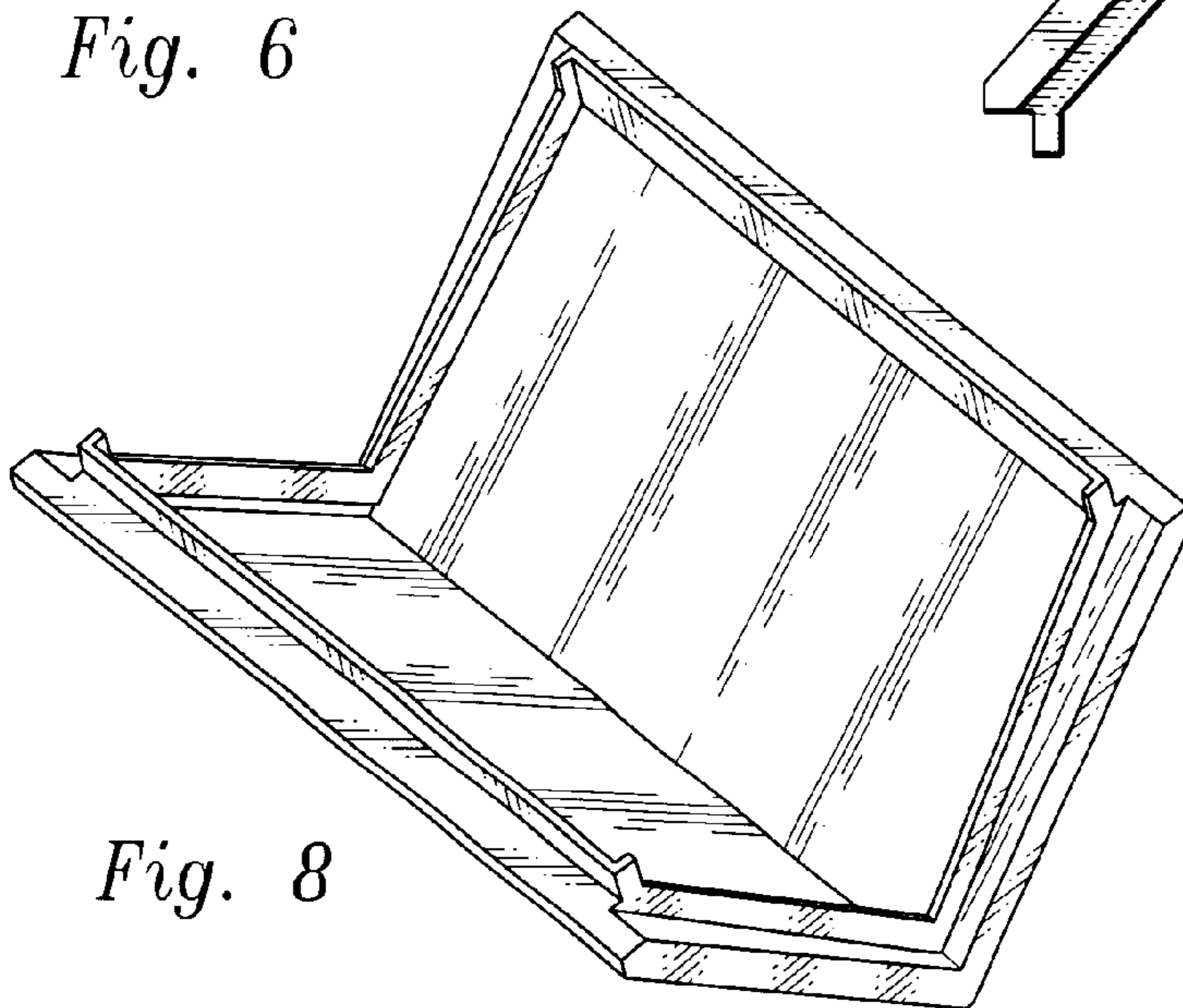

Fig. 8

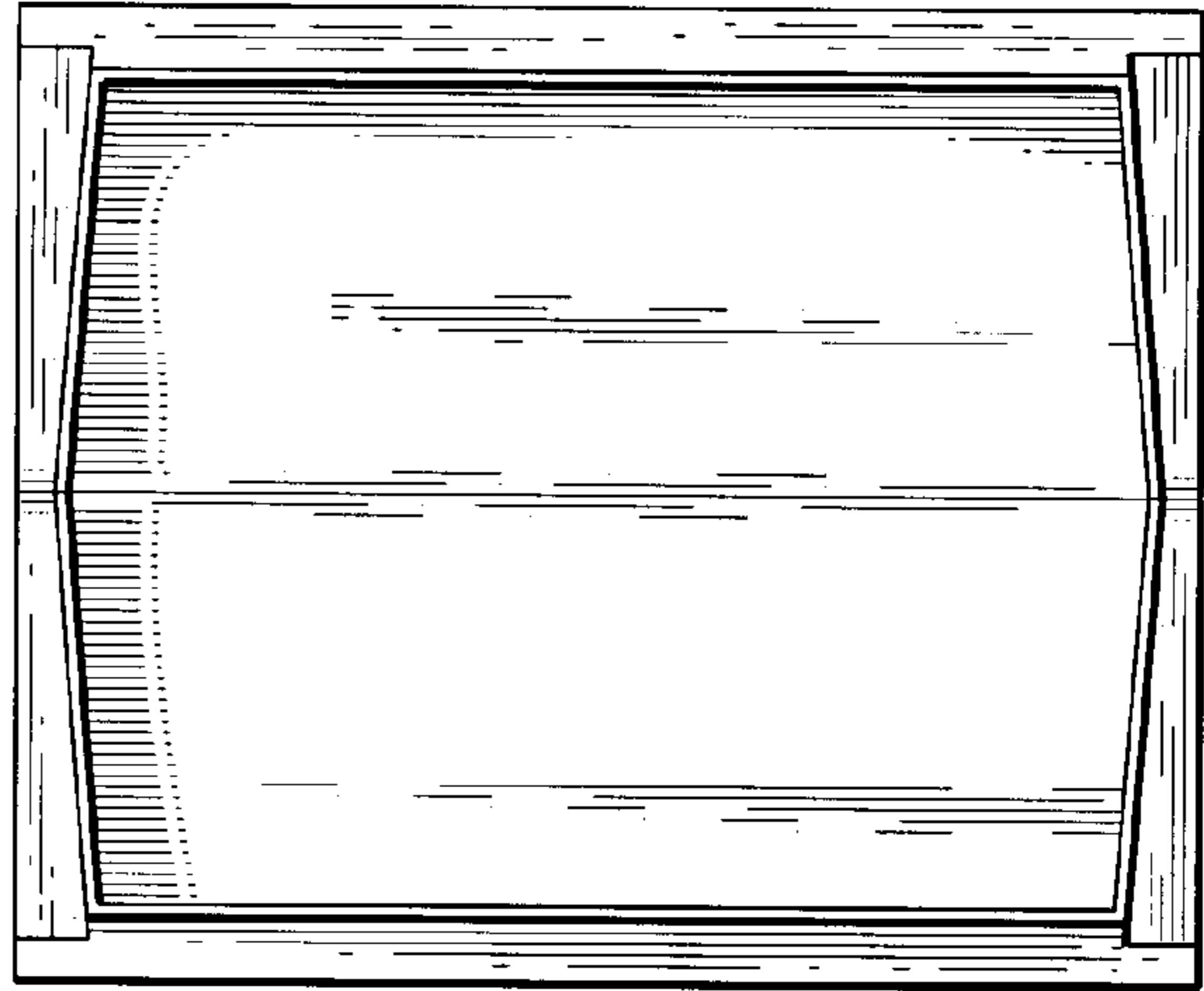

Fig. 9

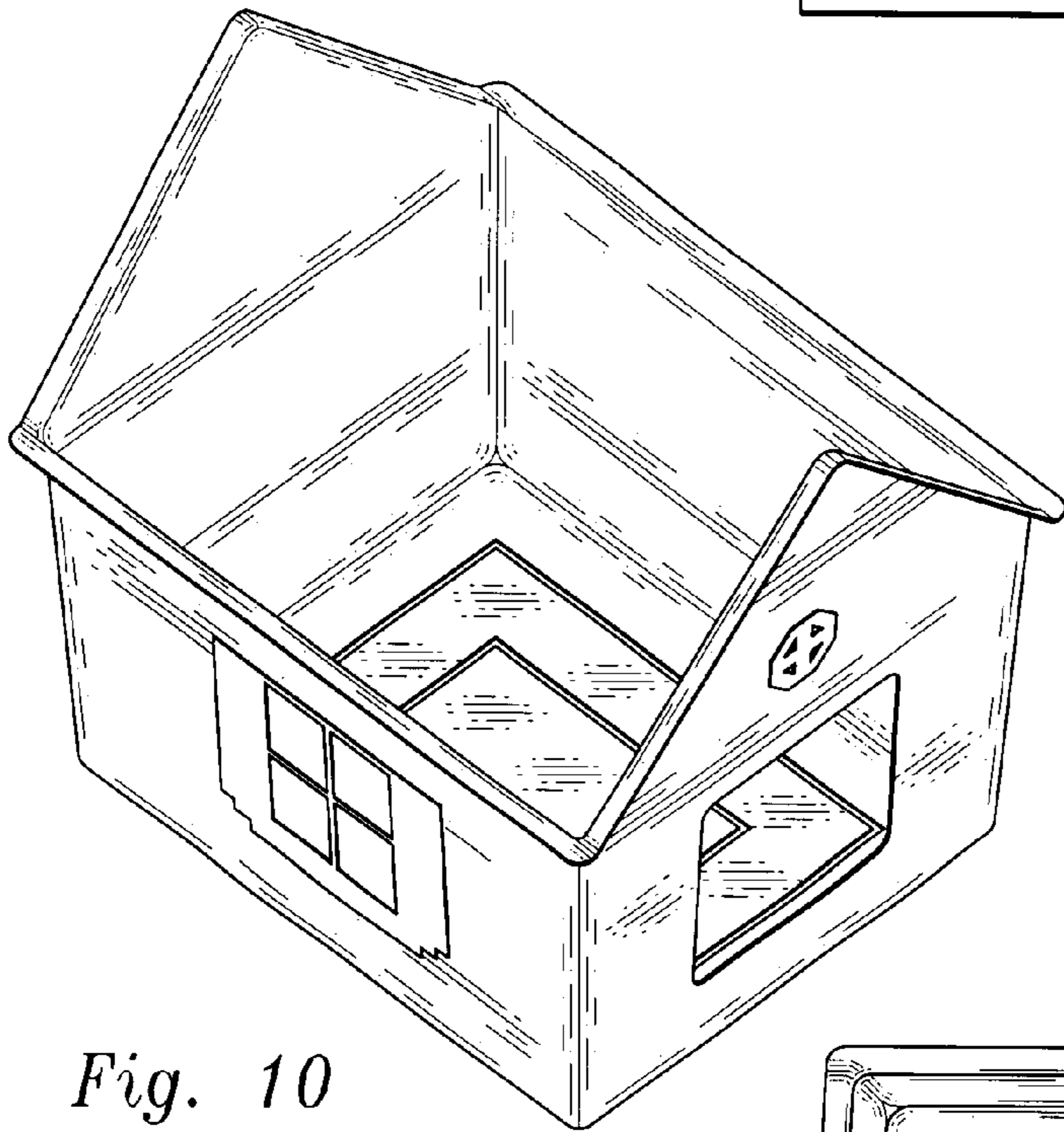

Fig. 10

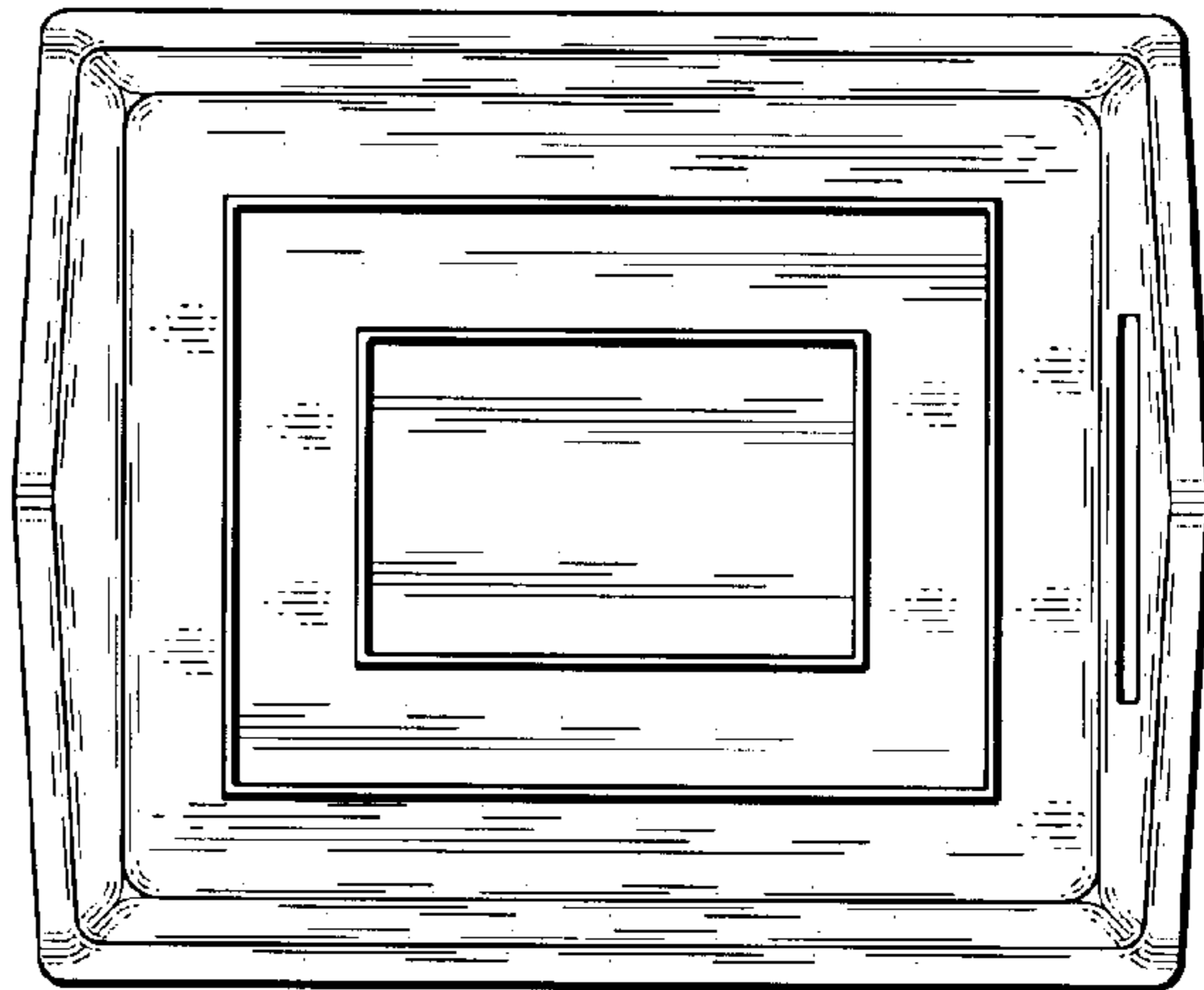

Fig. 11

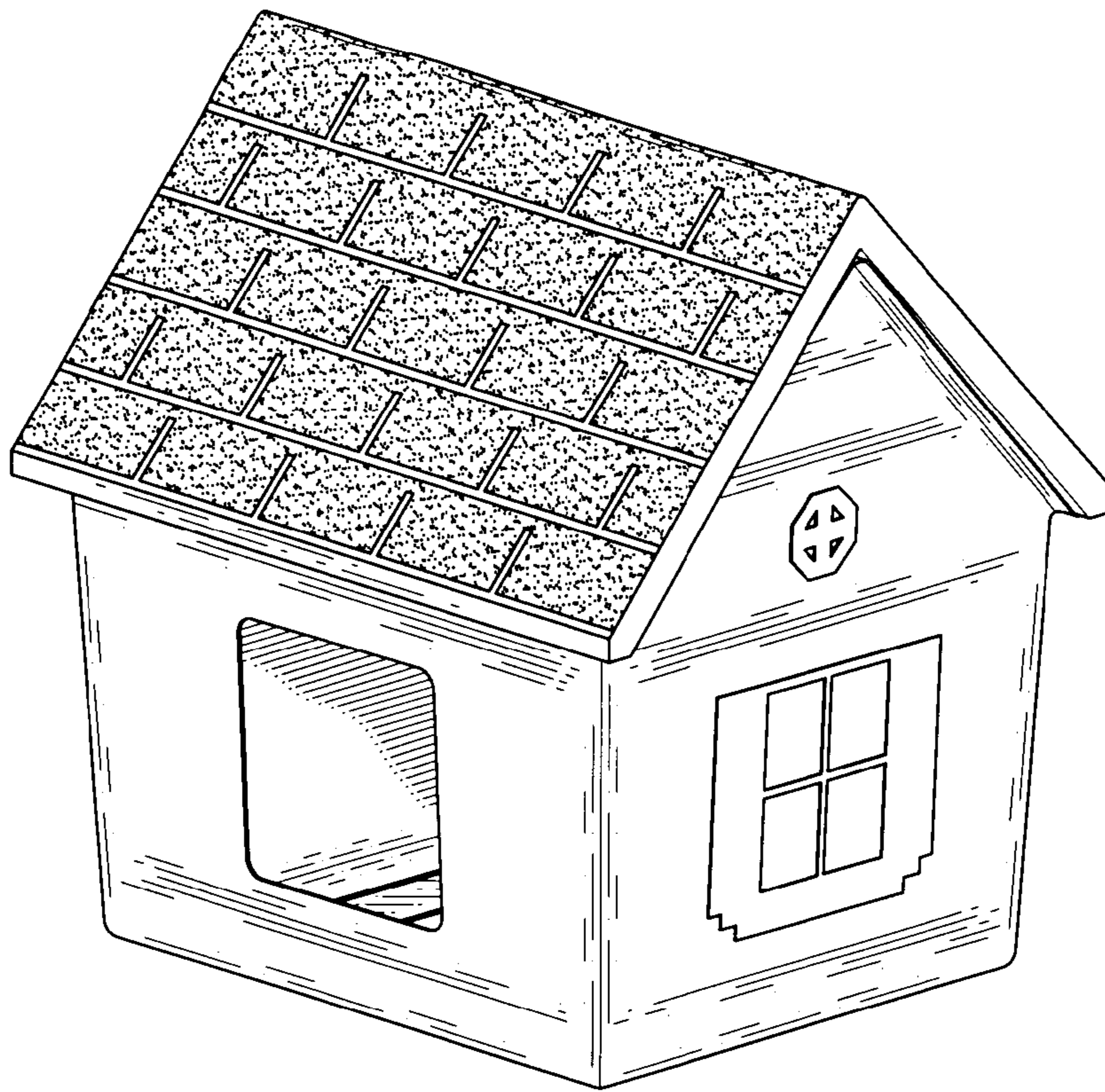

Fig. 12

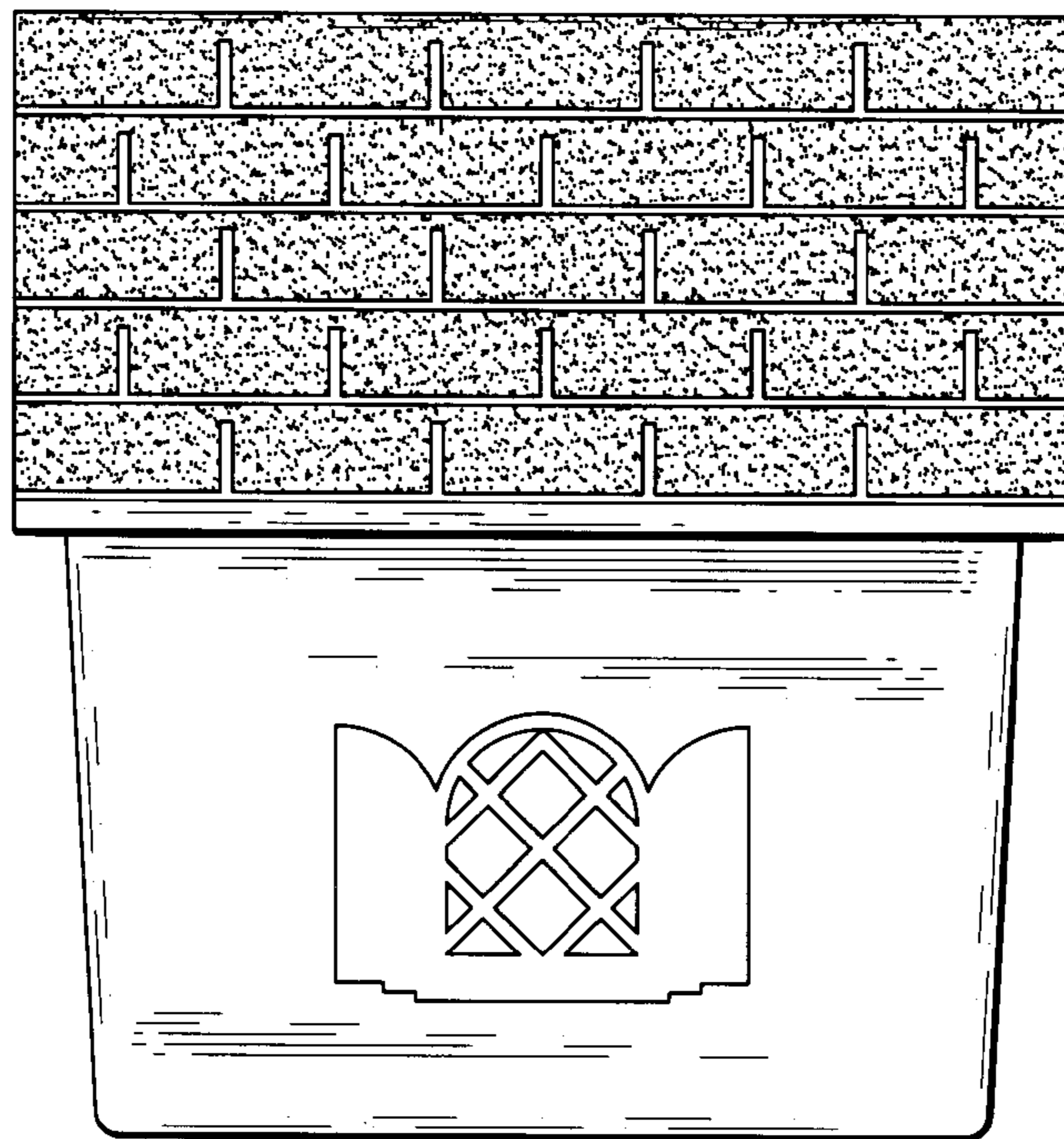

Fig. 13

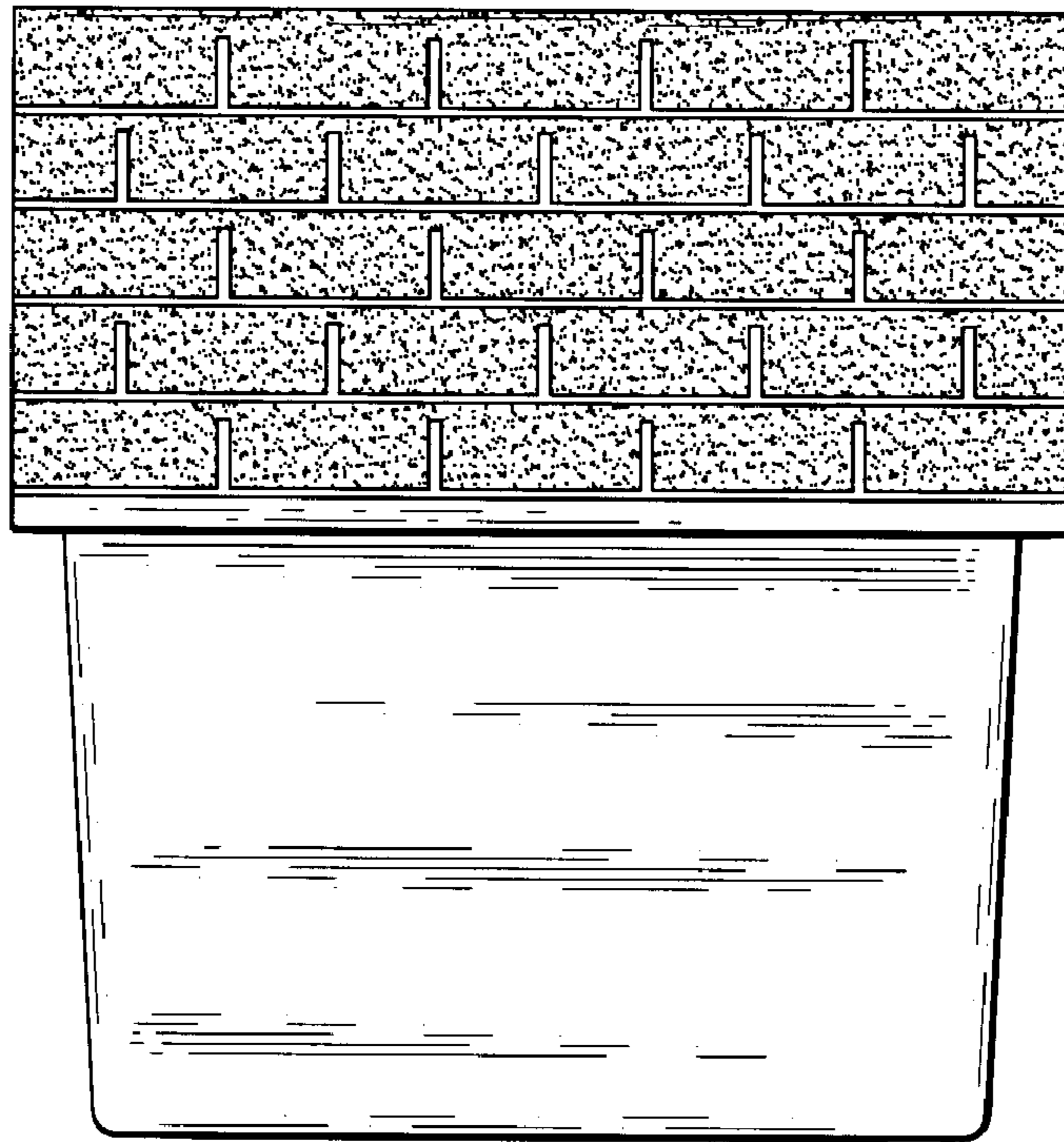

Fig. 14

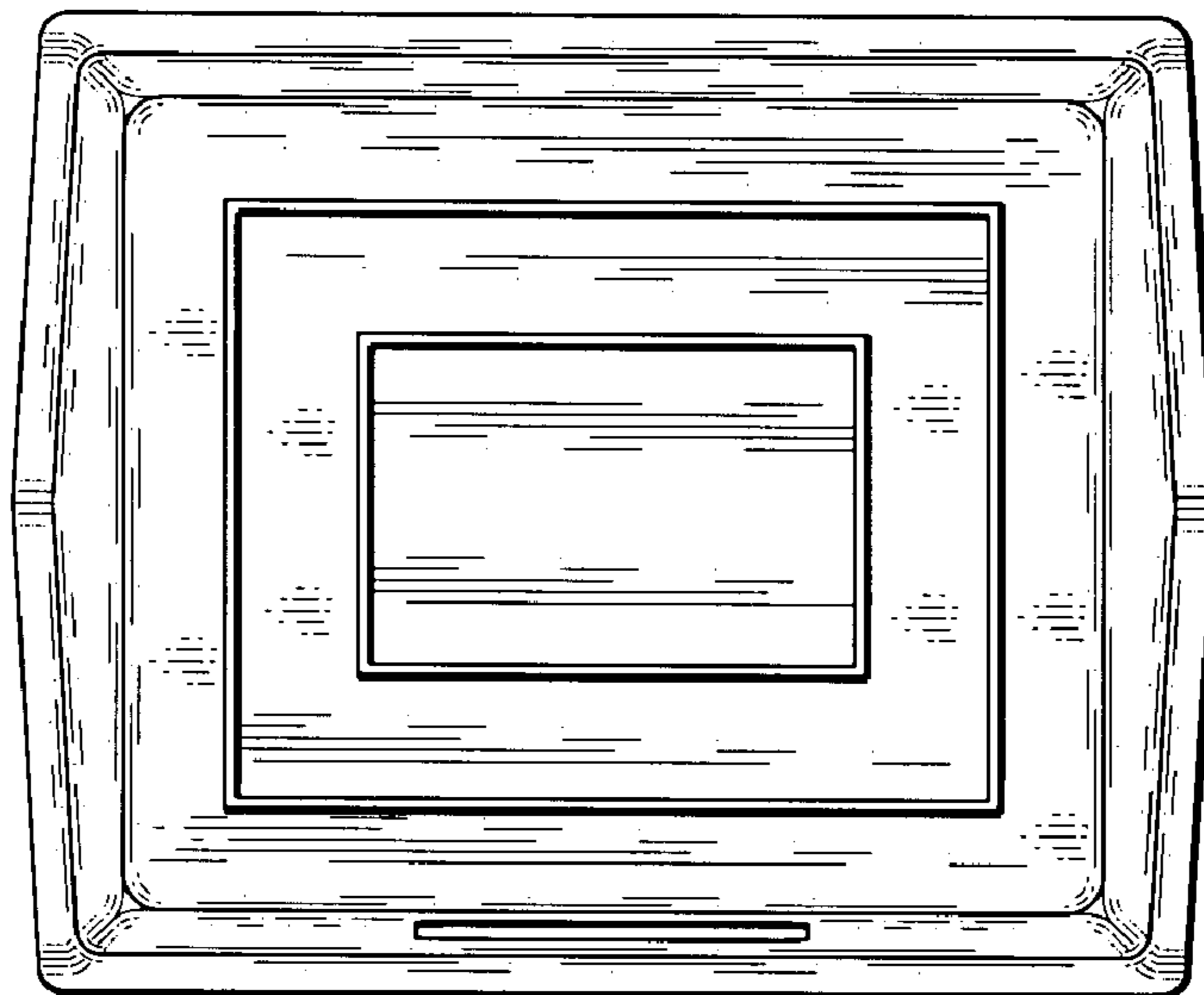

Fig. 15