



US00D479357S

(12) **United States Design Patent**
Focke et al.

(10) **Patent No.:** **US D479,357 S**

(45) **Date of Patent:** **** Sep. 2, 2003**

(54) **CIGARETTE PACK**

(75) Inventors: **Heinz Focke**, Verden (DE); **Viktor Hein**, Verden (DE); **Reinhard Lohmann**, Scheessel (DE); **Hans Schönberger**, Verden (DE)

(73) Assignee: **Focke & Co. (GmbH) & Co.**, Verden (DE)

(**) Term: **14 Years**

(21) Appl. No.: **29/173,727**

(22) Filed: **Jan. 6, 2003**

(30) **Foreign Application Priority Data**

Jul. 5, 2002 (WO) DM/060 954

(51) **LOC (7) Cl.** **27-06**

(52) **U.S. Cl.** **D27/189**

(58) **Field of Search** D27/183, 189,
D27/190, 191; 206/38, 261, 263, 268, 271,
273, 265; 229/160.1

(56) **References Cited**

U.S. PATENT DOCUMENTS

5,044,550 A * 9/1991 Lamm 229/160.1

6,168,014 B1 * 1/2001 Manservigi et al. 206/268

* cited by examiner

Primary Examiner—Jennifer Rivard

(74) *Attorney, Agent, or Firm*—Sughrue Mion, PLLC

(57) **CLAIM**

The ornamental design for a cigarette pack, as shown and described.

DESCRIPTION

FIG. 1 is a perspective view of the top, front and left side view of a cigarette pack according to a first embodiment showing our new design;

FIG. 2 is a perspective view similar to FIG. 1 with the cover in the cover in the open position;

FIG. 3 is a left side elevational view thereof;

FIG. 4 is a right side elevational view thereof;

FIG. 5 is a front elevational view thereof;

FIG. 6 is a rear elevational view thereof;

FIG. 7 is a top plan view thereof, the bottom plan view being identical thereto,

FIG. 8 is a perspective view of the top, front and left side of a cigarette pack according to a second embodiment;

FIG. 9 is a perspective view similar to FIG. 8 with the cover in the open position;

FIG. 10 is a left side elevational view thereof;

FIG. 11 is a right side elevational view thereof;

FIG. 12 is a front elevational view thereof;

FIG. 13 is a rear elevational view thereof; and,

FIG. 14 is a top plan view thereof, the bottom plan view being identical thereto.

1 Claim, 8 Drawing Sheets

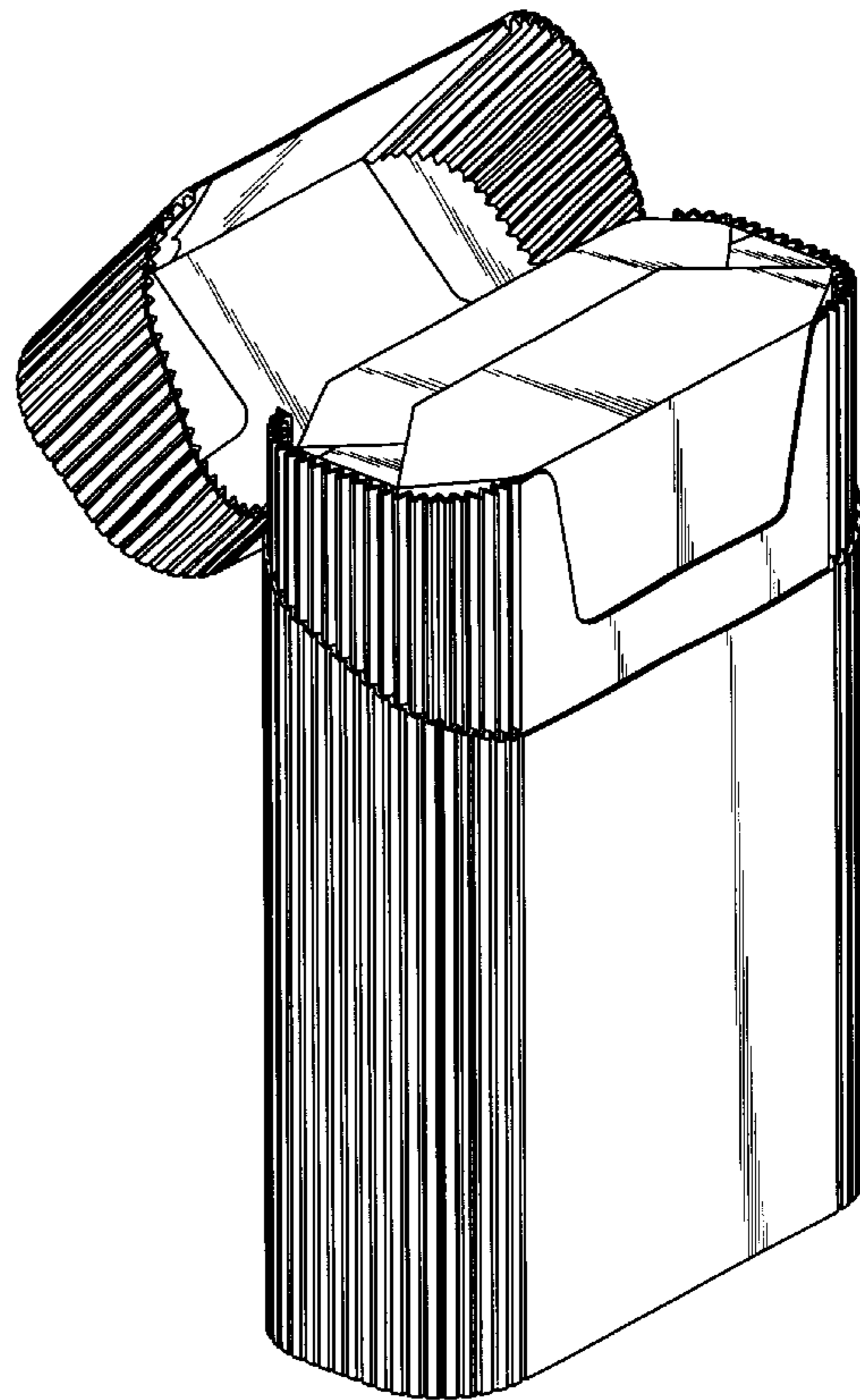
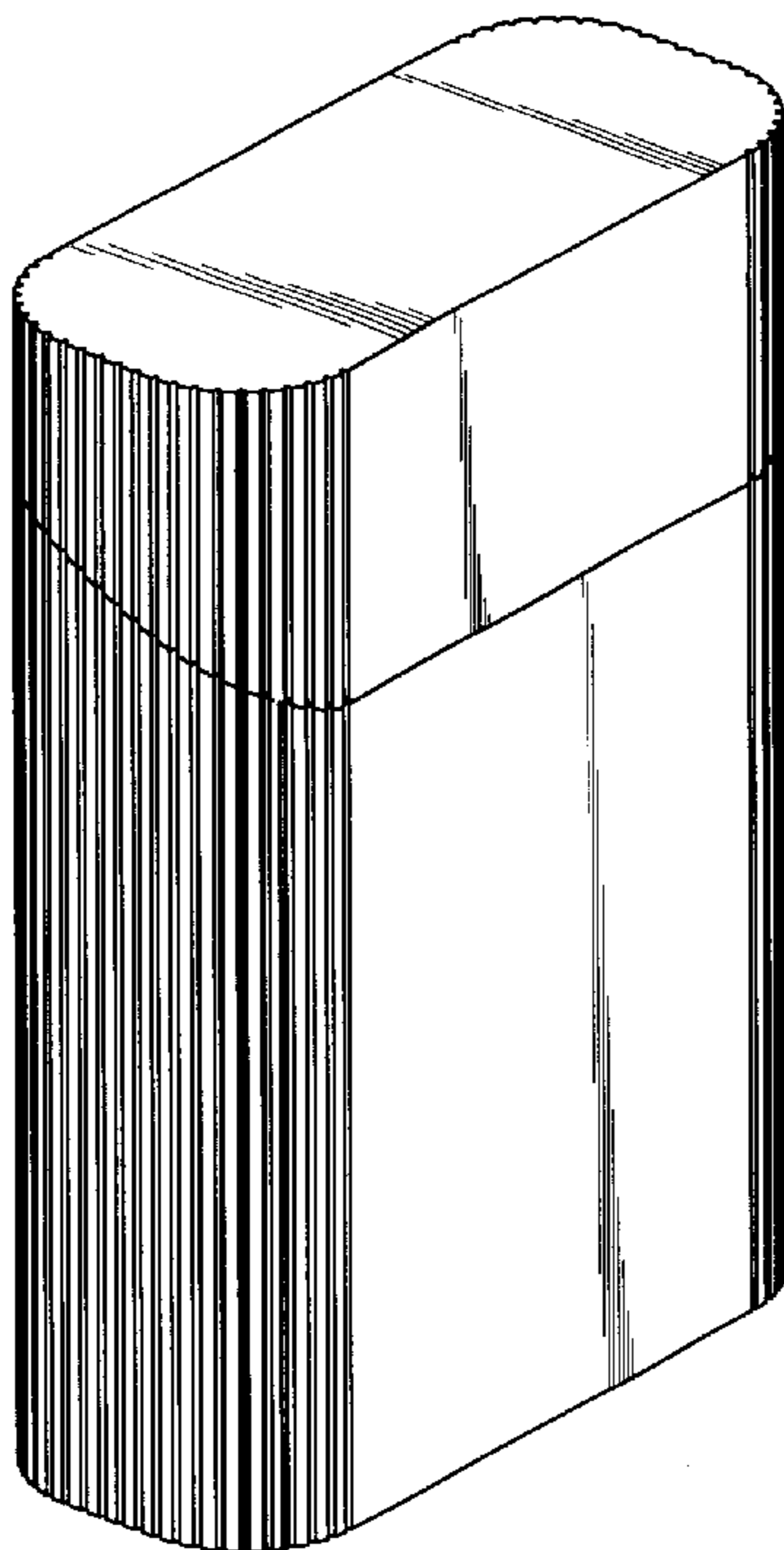

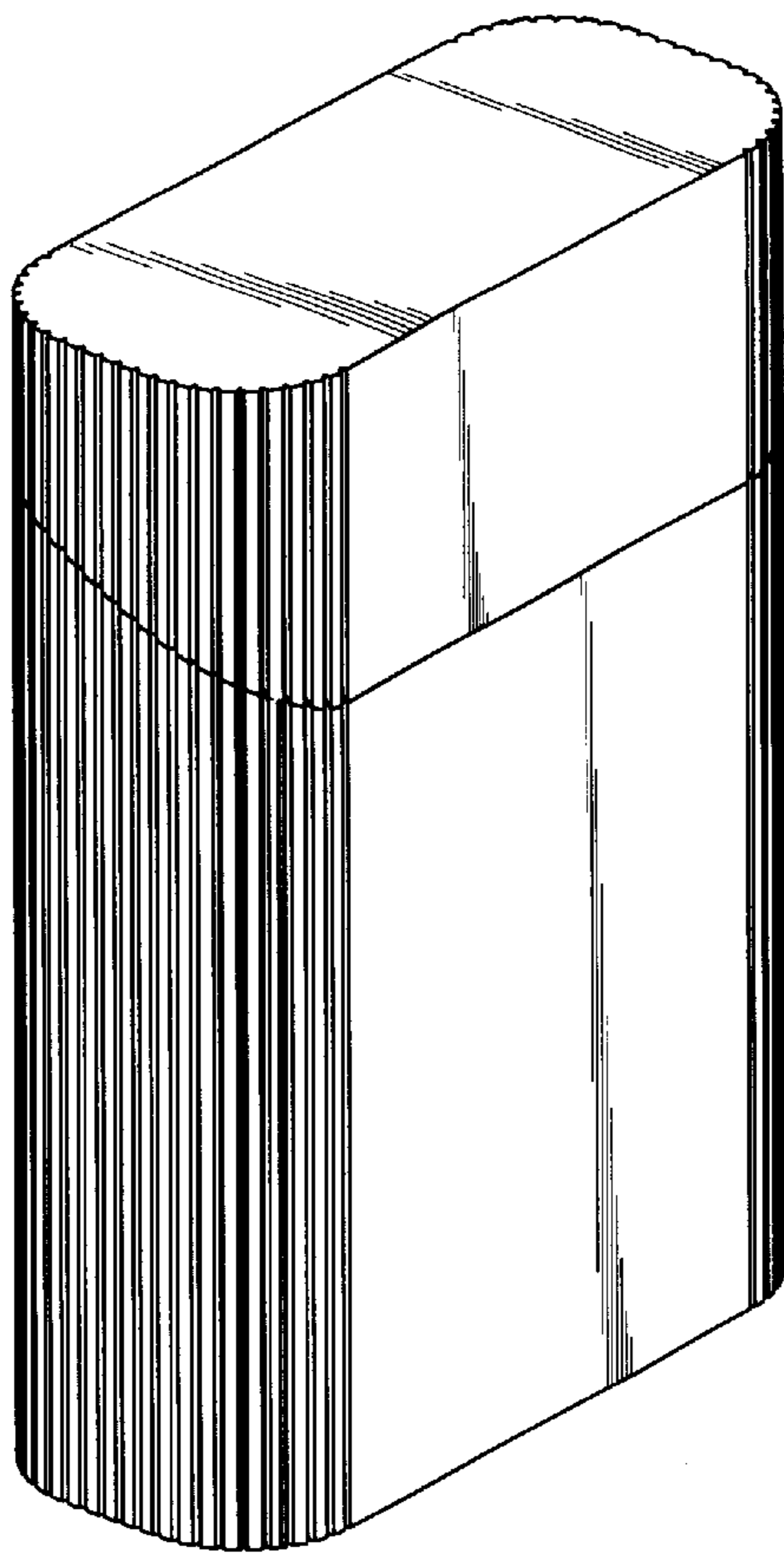

Fig. 1

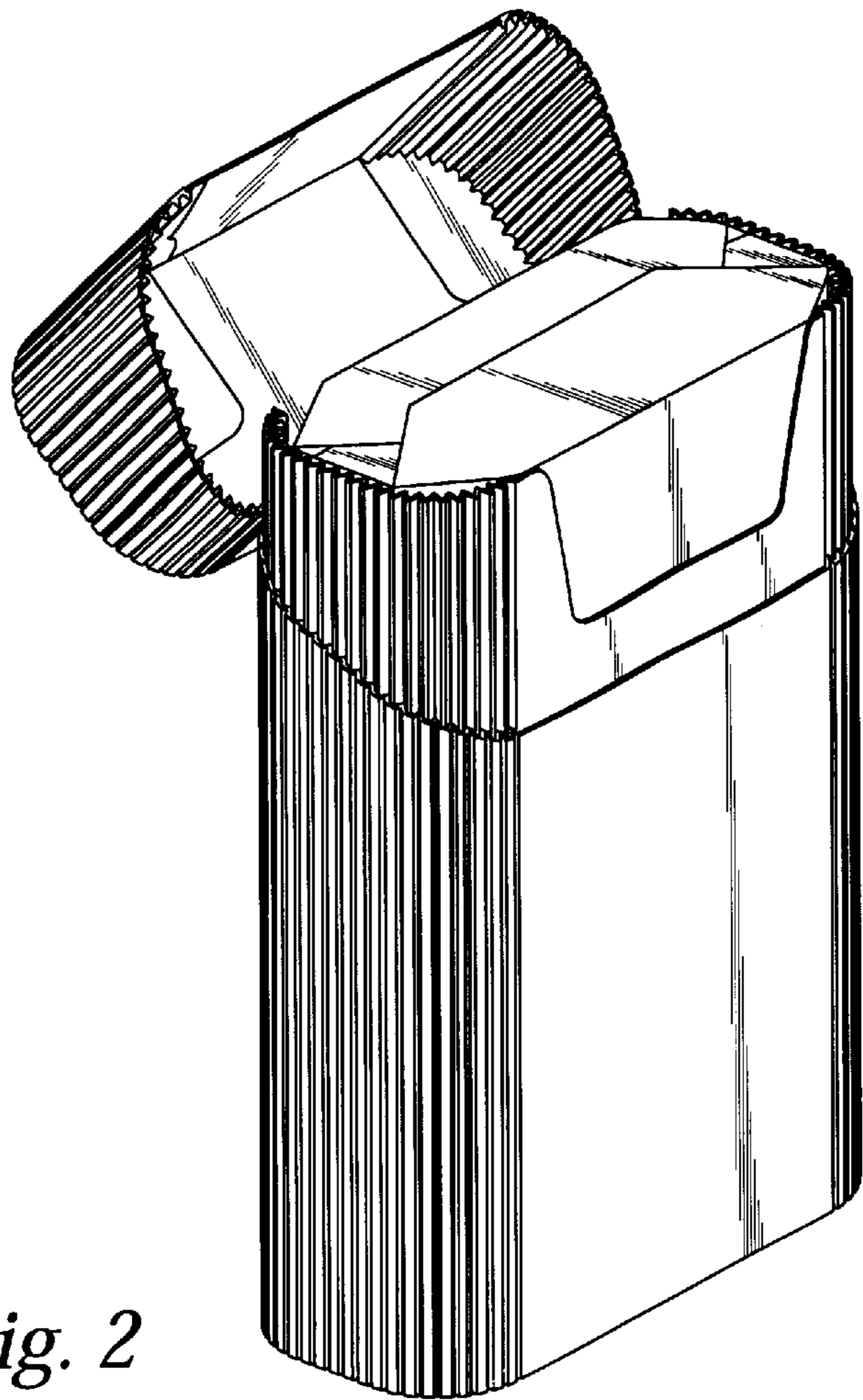

Fig. 2

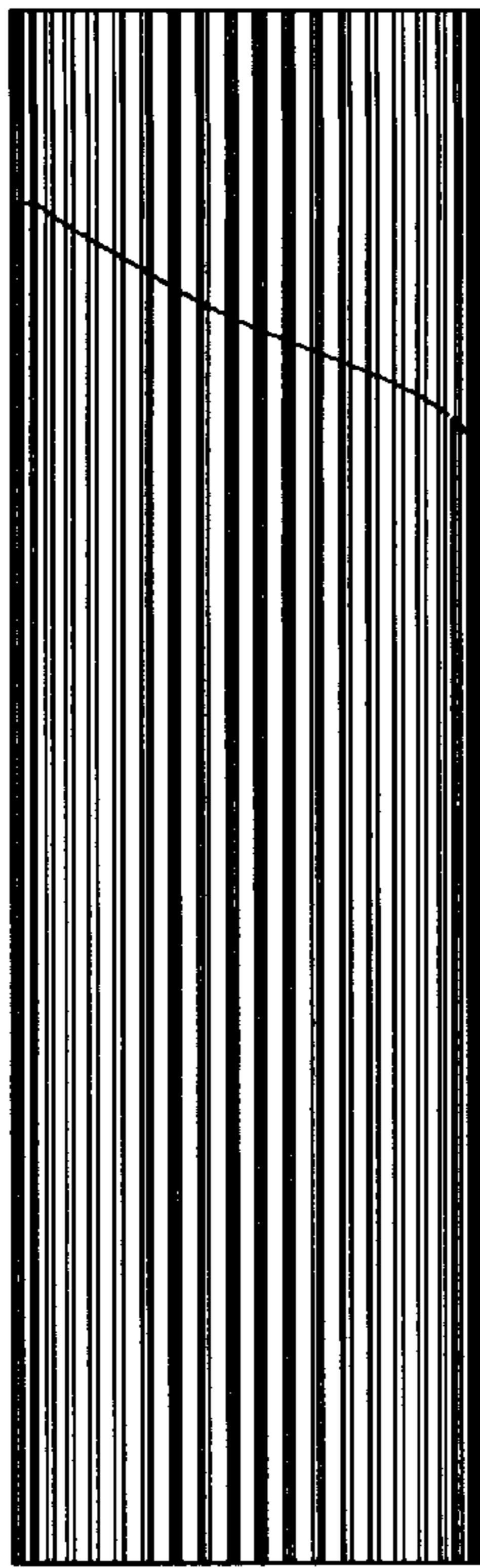

Fig. 3

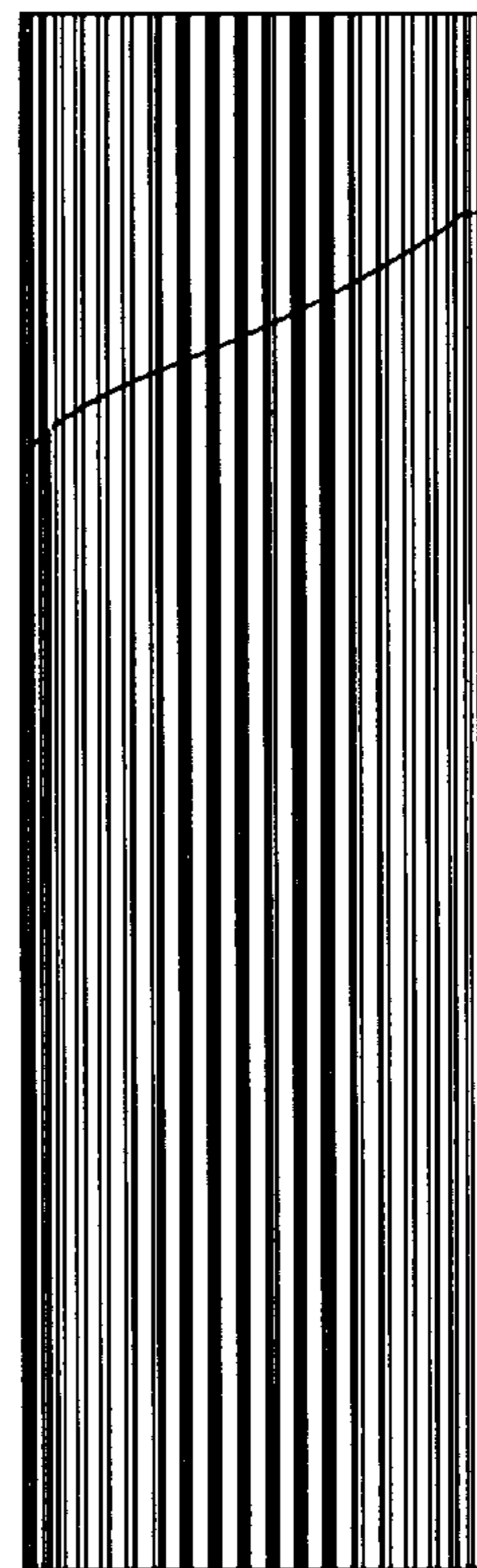

Fig. 4

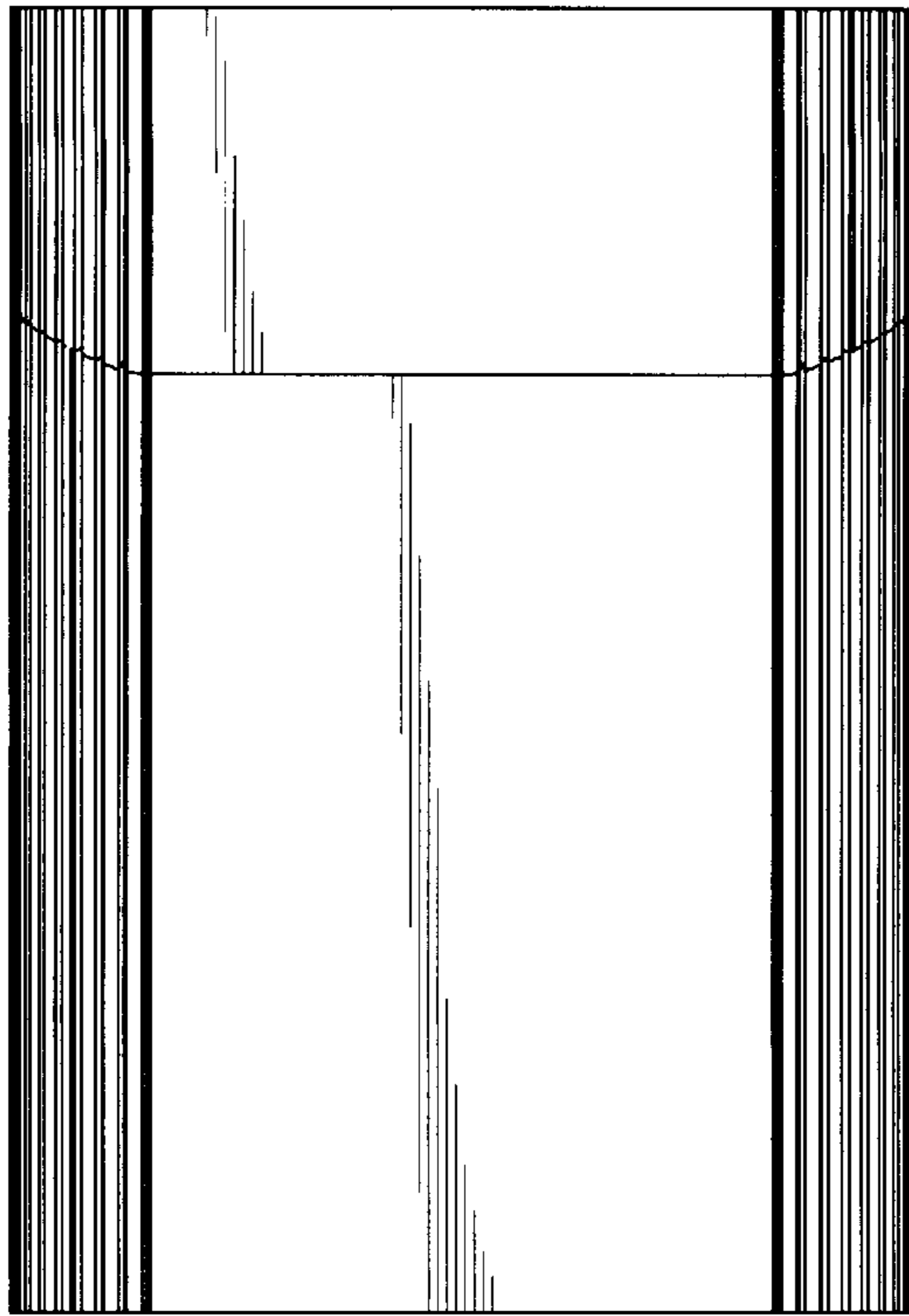

Fig. 5

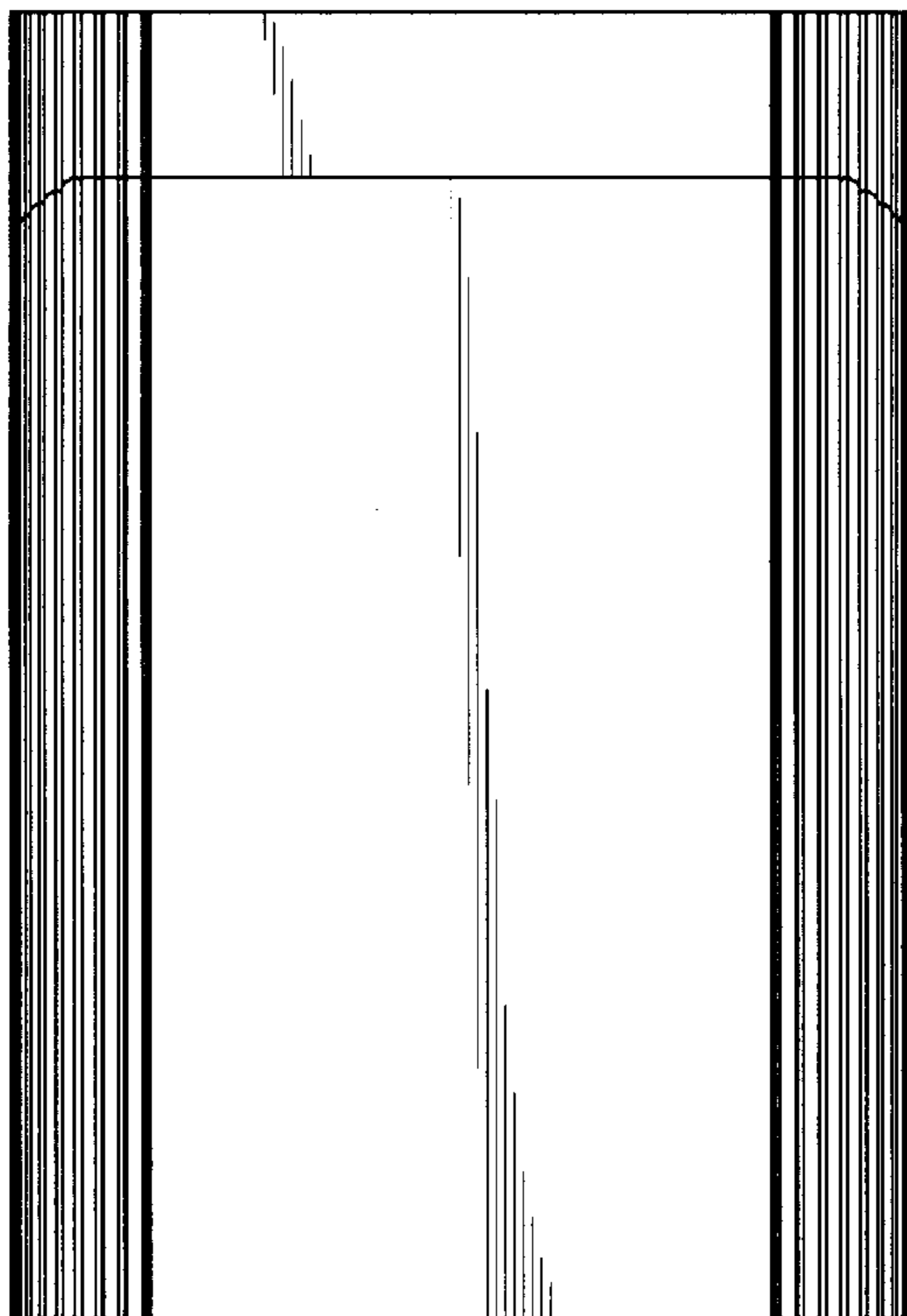

Fig. 6

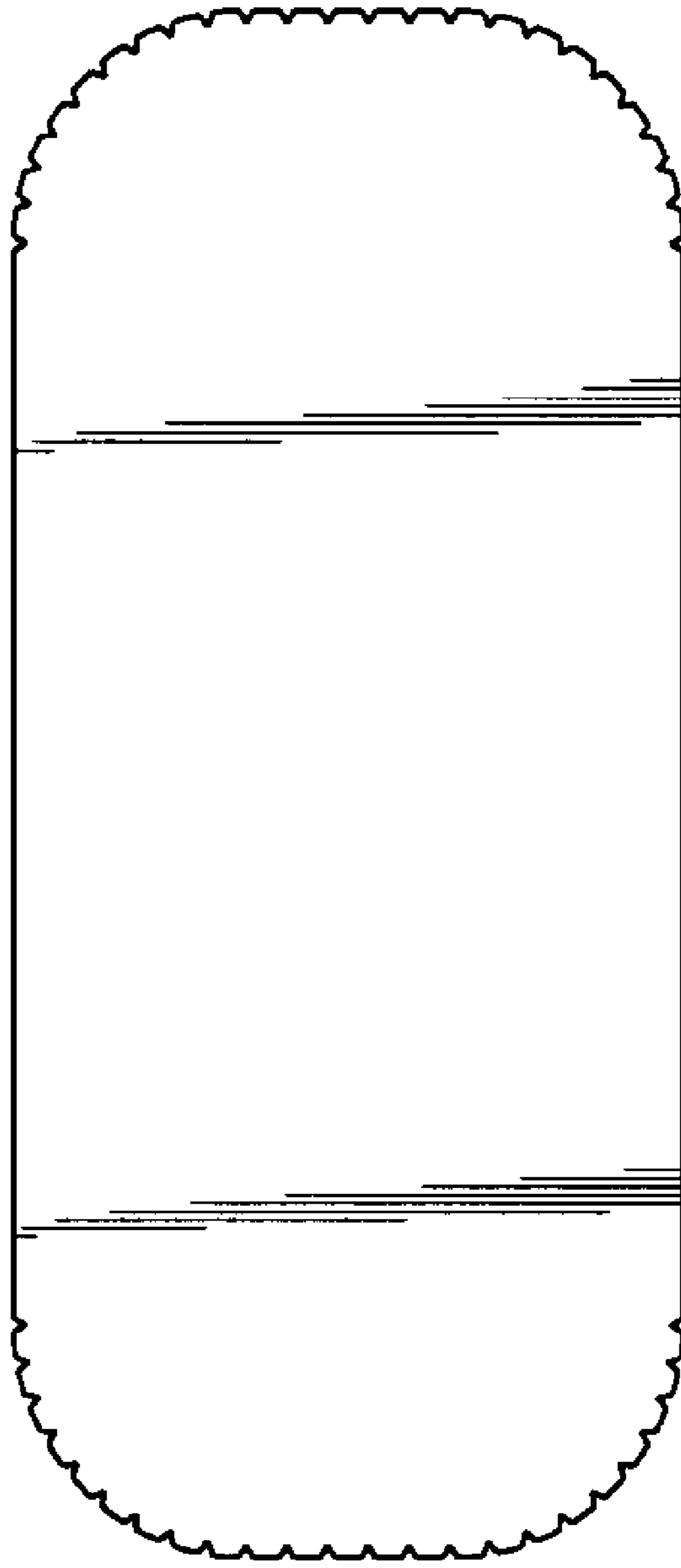

Fig. 7

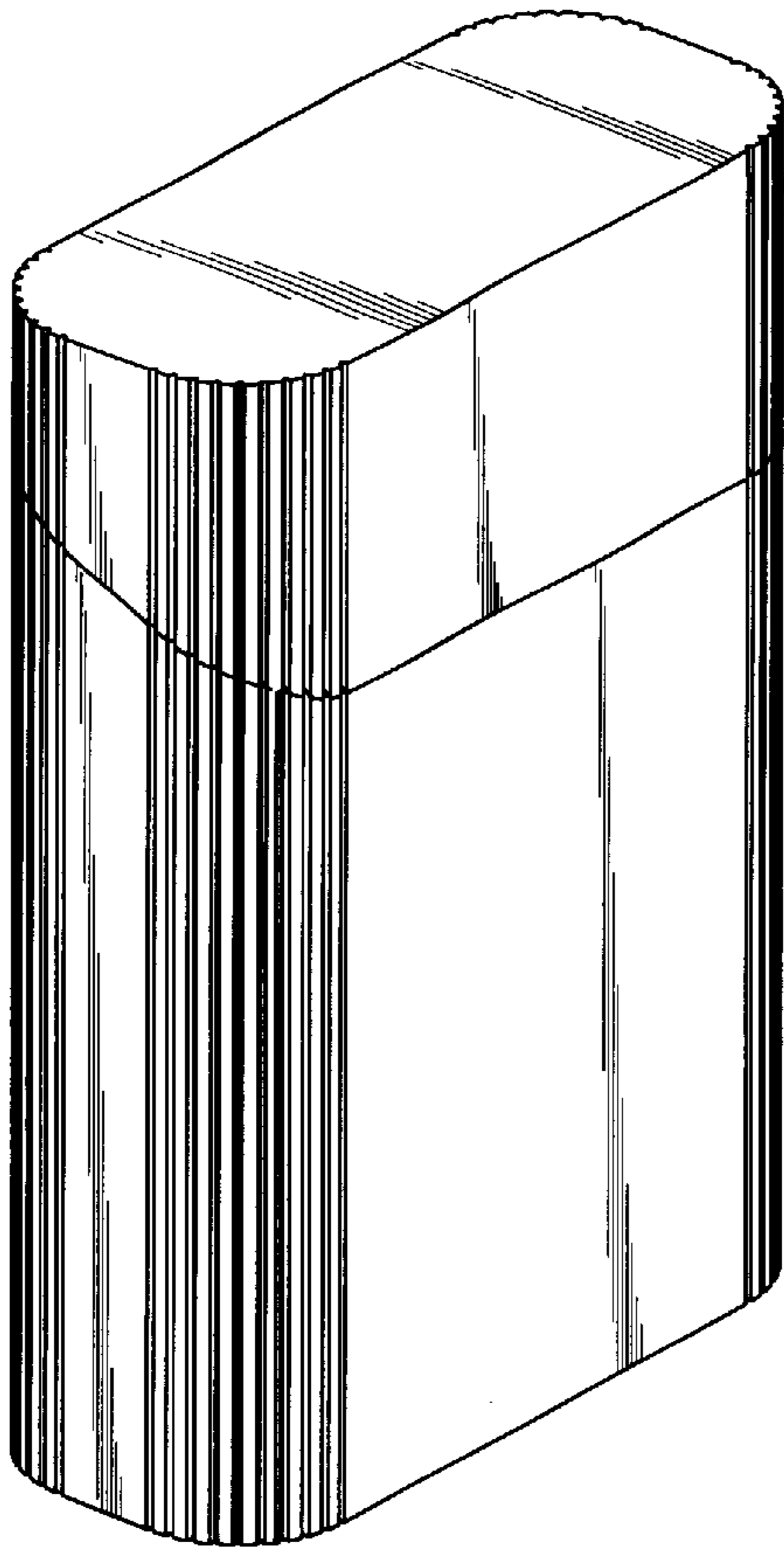

Fig. 8

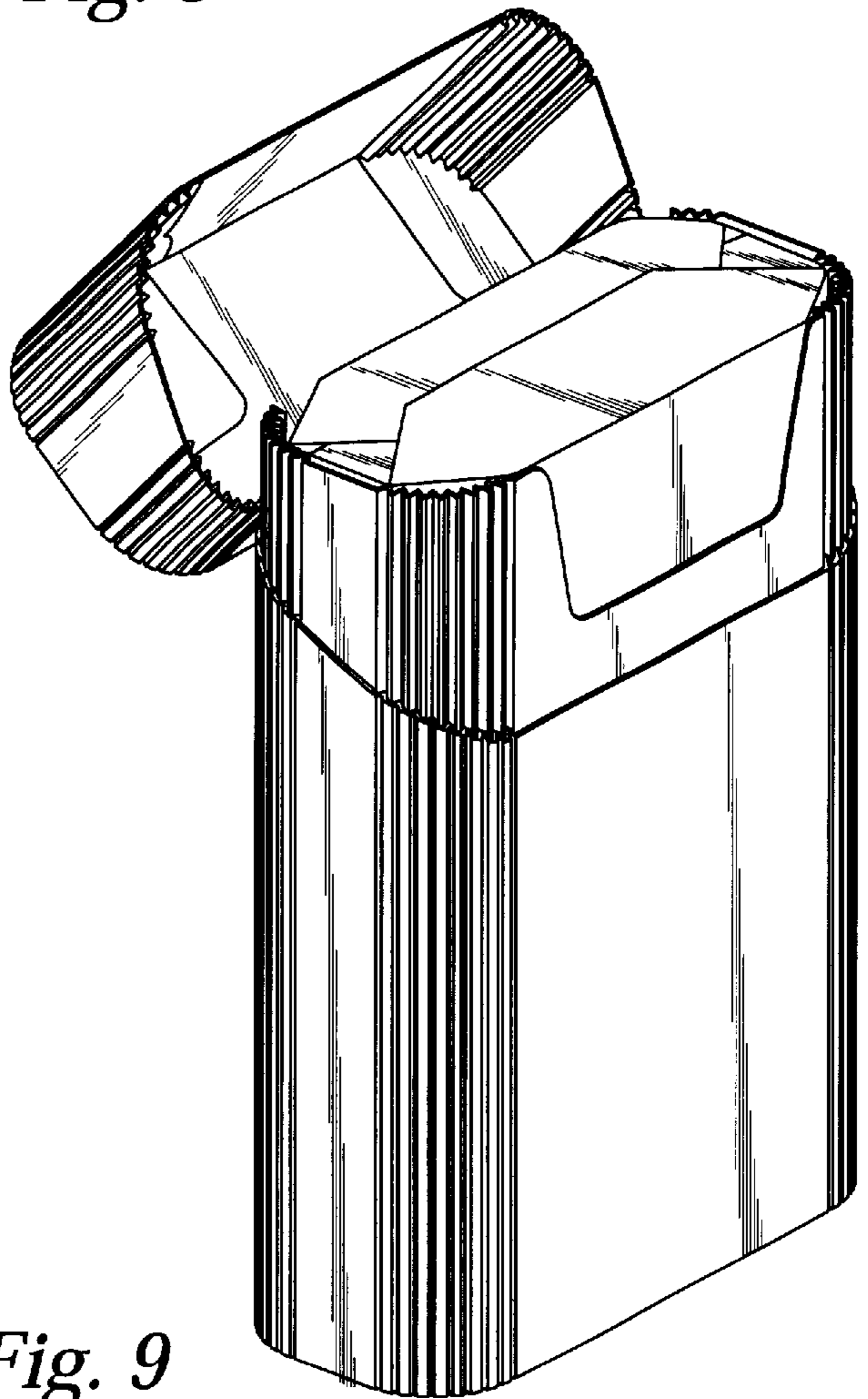

Fig. 9

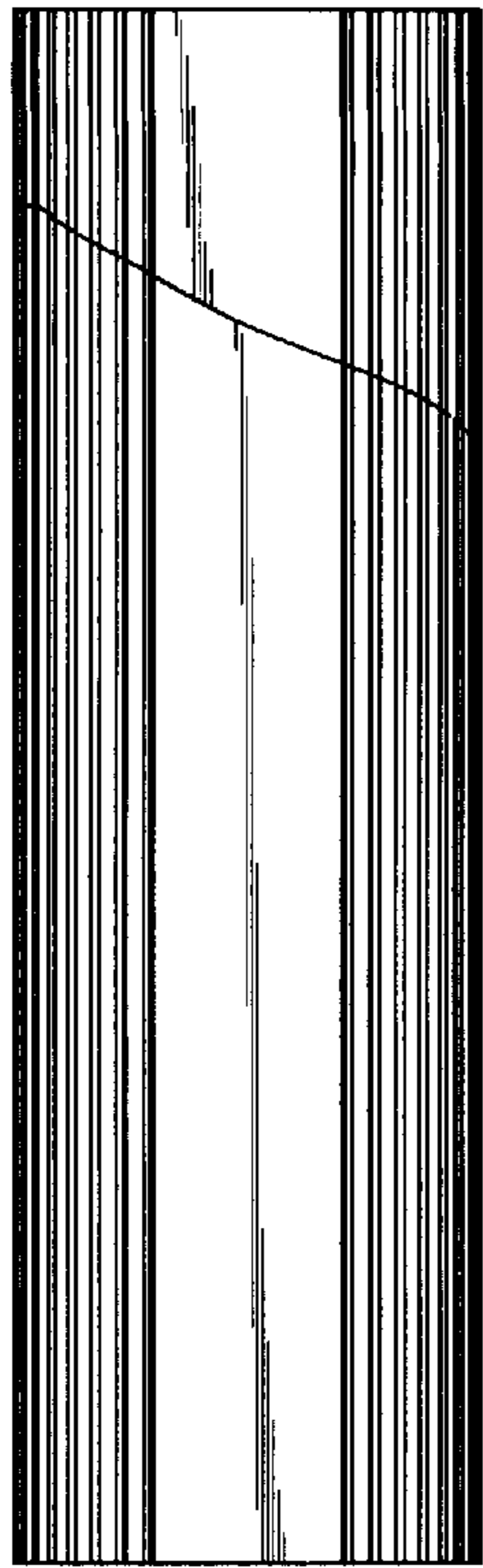

Fig. 10

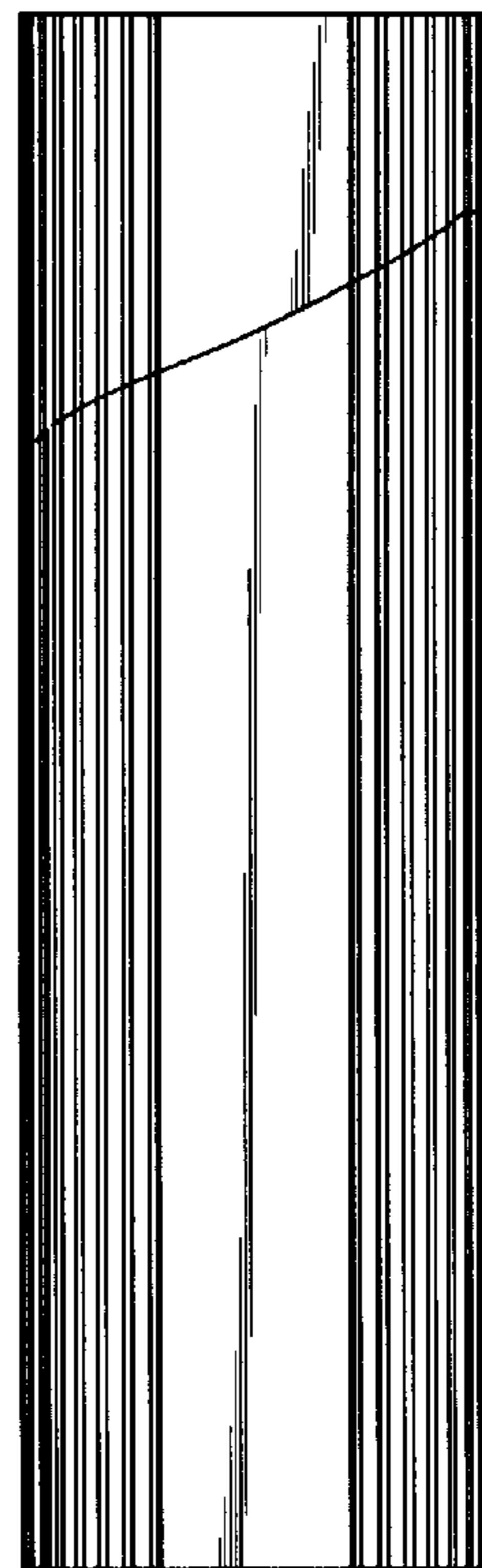

Fig. 11

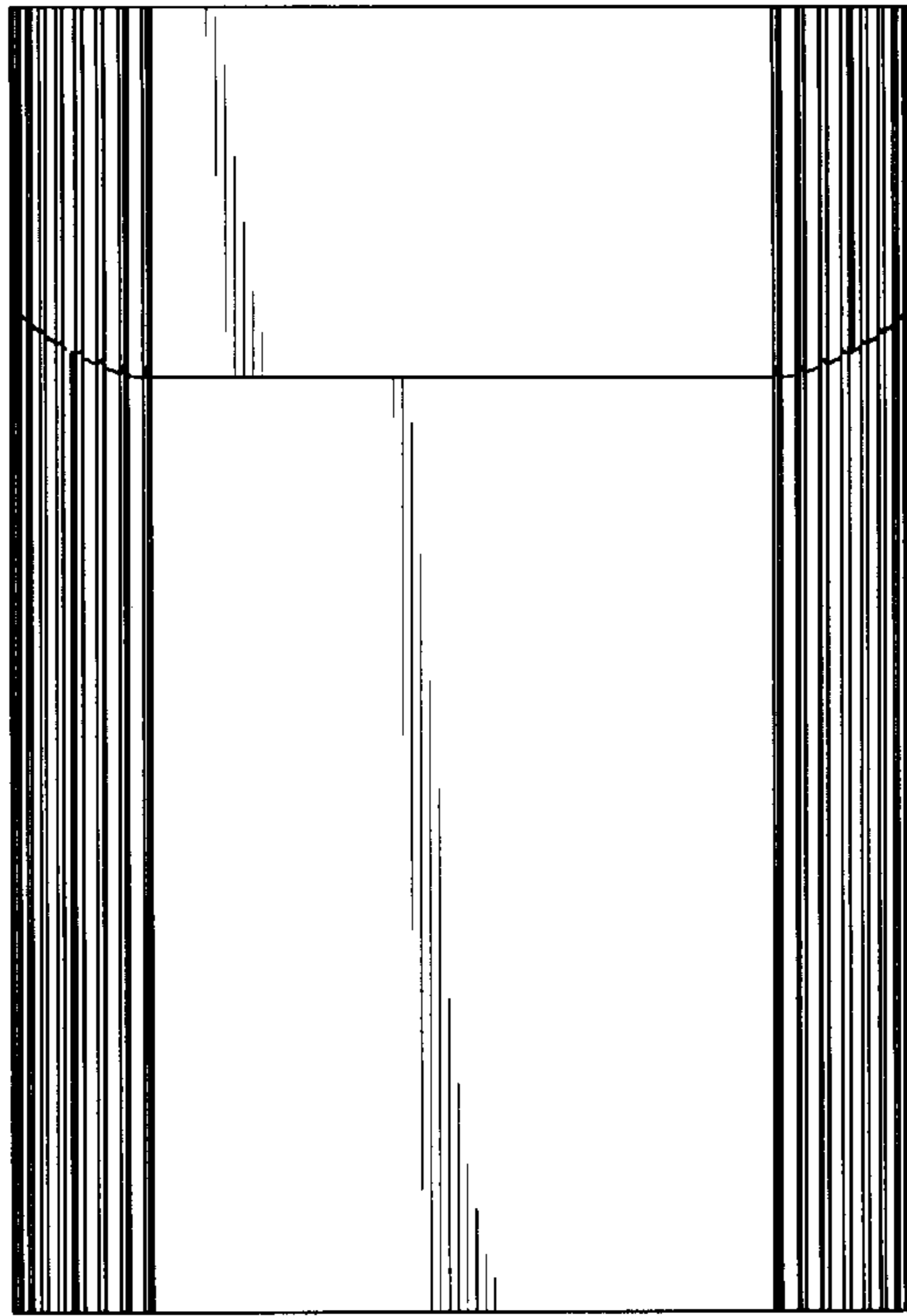

Fig. 12

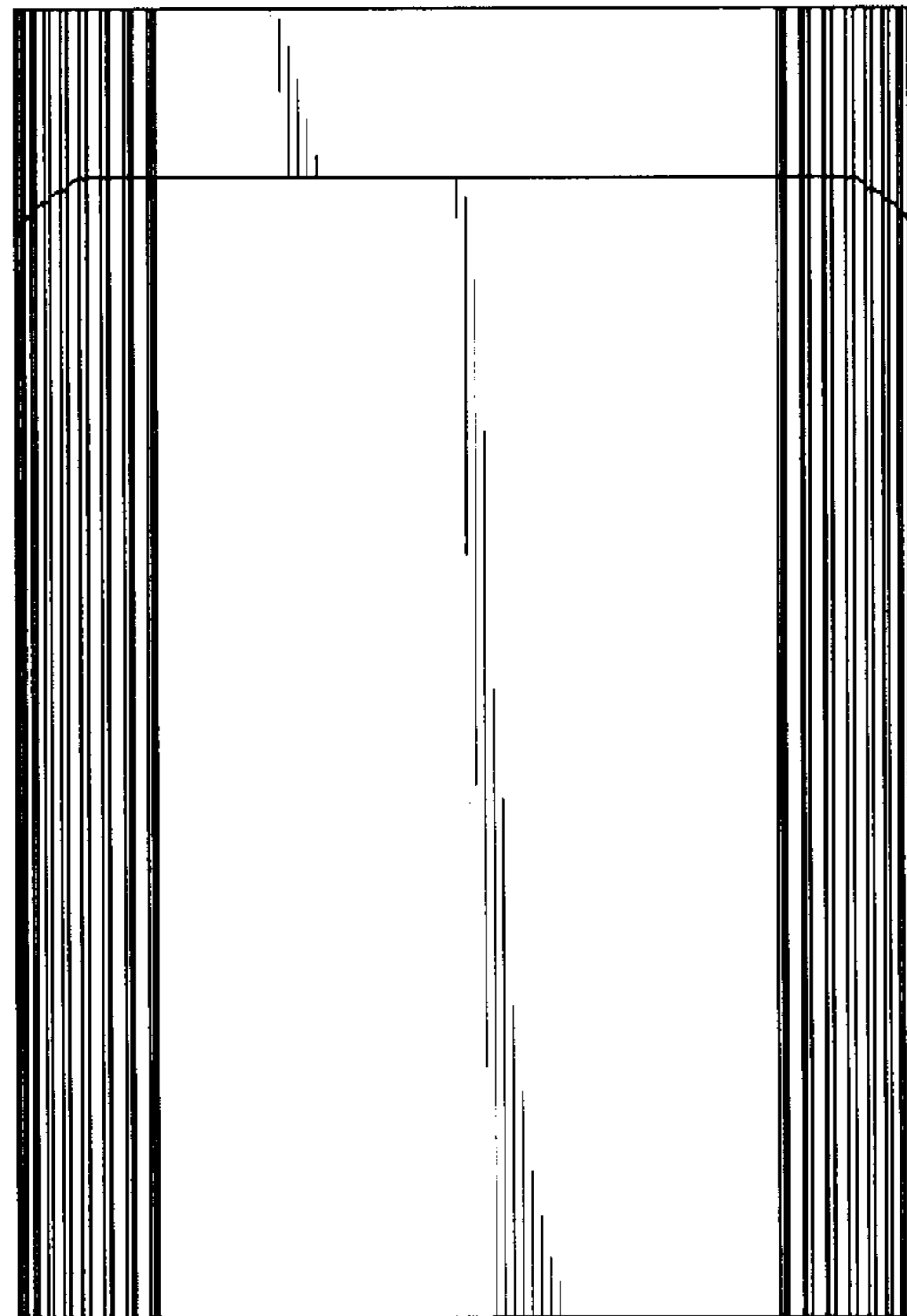

Fig. 13

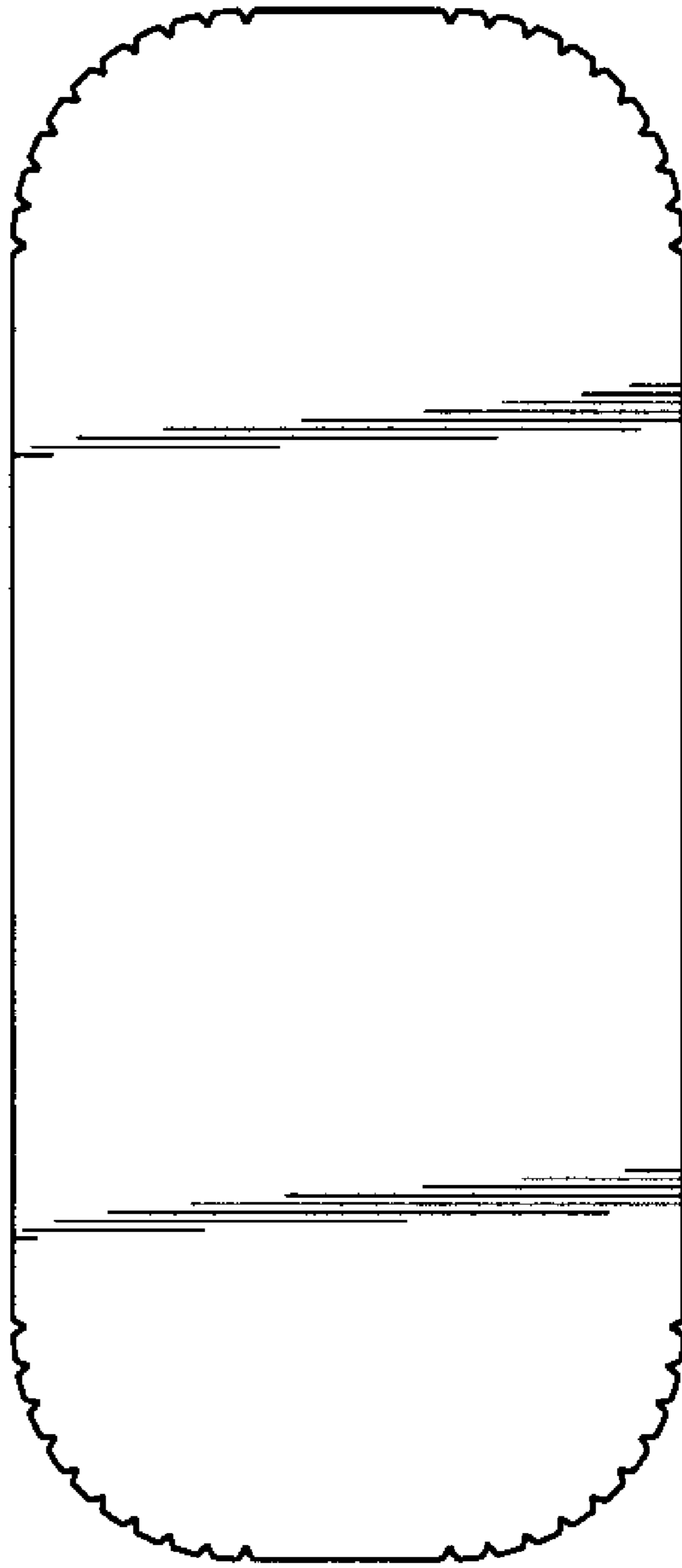

Fig. 14