



US00D479347S

(12) **United States Design Patent**
Kakuno et al.

(10) **Patent No.:** **US D479,347 S**

(45) **Date of Patent:** **** Sep. 2, 2003**

(54) **FLUORESCENT LAMP**

D437,946 S 2/2001 Choi
D448,502 S 9/2001 Choi

(75) Inventors: **Yoshinori Kakuno**, Osaka (JP); **Shirou Iida**, Kyoto (JP)

FOREIGN PATENT DOCUMENTS

(73) Assignee: **Matsushita Electric Industrial Co., Ltd.**, Osaka (JP)

CN 94300629 1/1995
CN 00338589 6/2001
JP 927965 6/1995

(**) Term: **14 Years**

* cited by examiner

(21) Appl. No.: **29/170,737**

Primary Examiner—Marcus A. Jackson

(22) Filed: **Nov. 8, 2002**

(74) *Attorney, Agent, or Firm*—Christensen O'Connor Johnson Kindness PLLC

(30) **Foreign Application Priority Data**

(57) **CLAIM**

May 10, 2002 (JP) 2002-012461

The ornamental design for a fluorescent lamp, as shown and described.

(51) **LOC (7) Cl.** **26-06**

DESCRIPTION

(52) **U.S. Cl.** **D26/3**

(58) **Field of Search** D26/1, 2, 3, 26;
313/313, 315, 317, 318, 493; 315/52, 53,
56, 57, 58; 362/216, 222, 310

FIG. 1 is a perspective view of the top, front and right side of a fluorescent lamp showing our new design;
FIG. 2 is a front view thereof;
FIG. 3 is a rear view thereof;
FIG. 4 is a left side view thereof;
FIG. 5 is a right side view thereof;
FIG. 6 is a top plan view thereof; and,
FIG. 7 is a bottom view thereof.

(56) **References Cited**

U.S. PATENT DOCUMENTS

D302,473 S * 7/1989 MacDonald et al. D26/3
D356,874 S * 3/1995 Sangen et al. D26/3
D400,988 S * 11/1998 Matsumura et al. D26/3

1 Claim, 4 Drawing Sheets

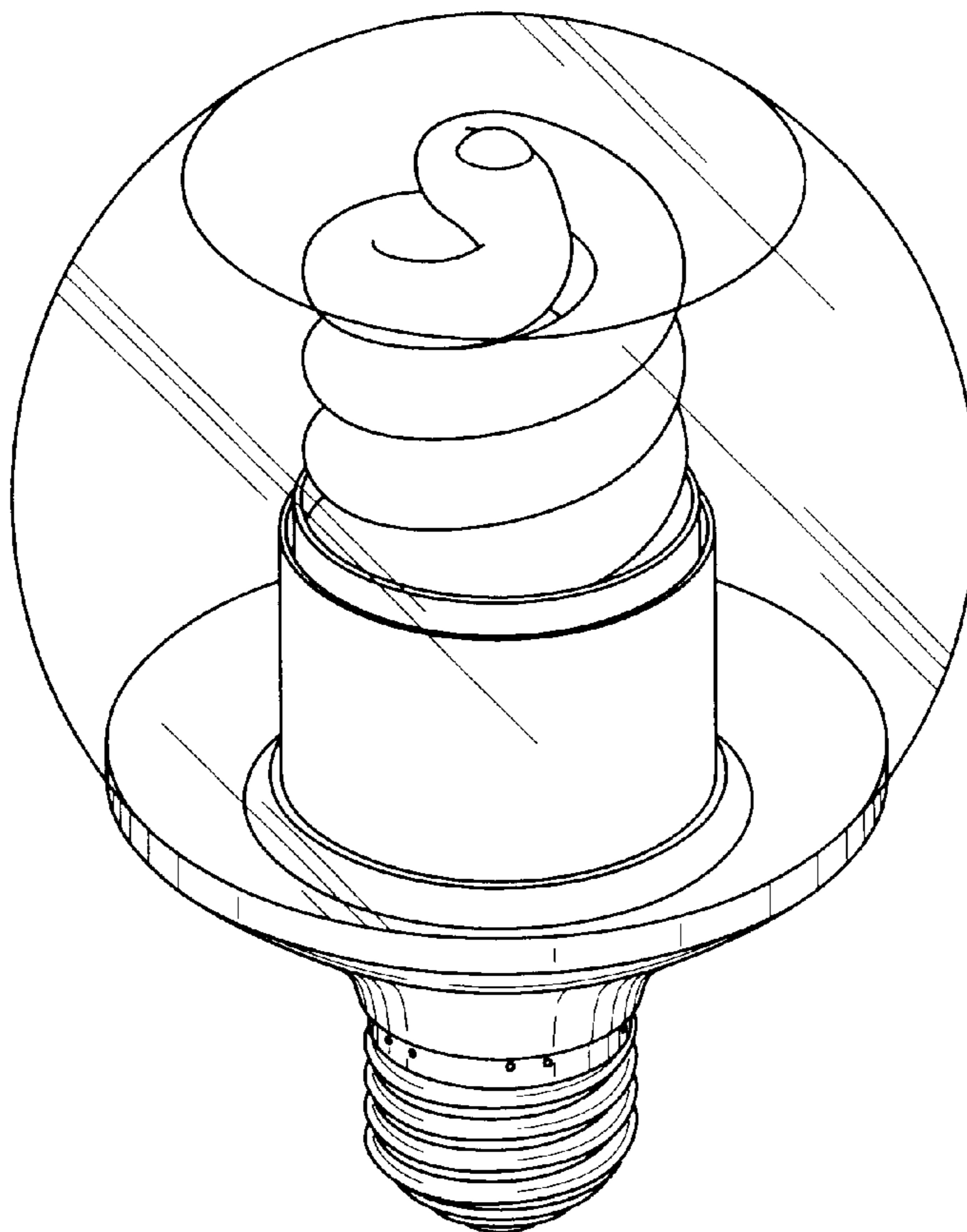

FIG. 1

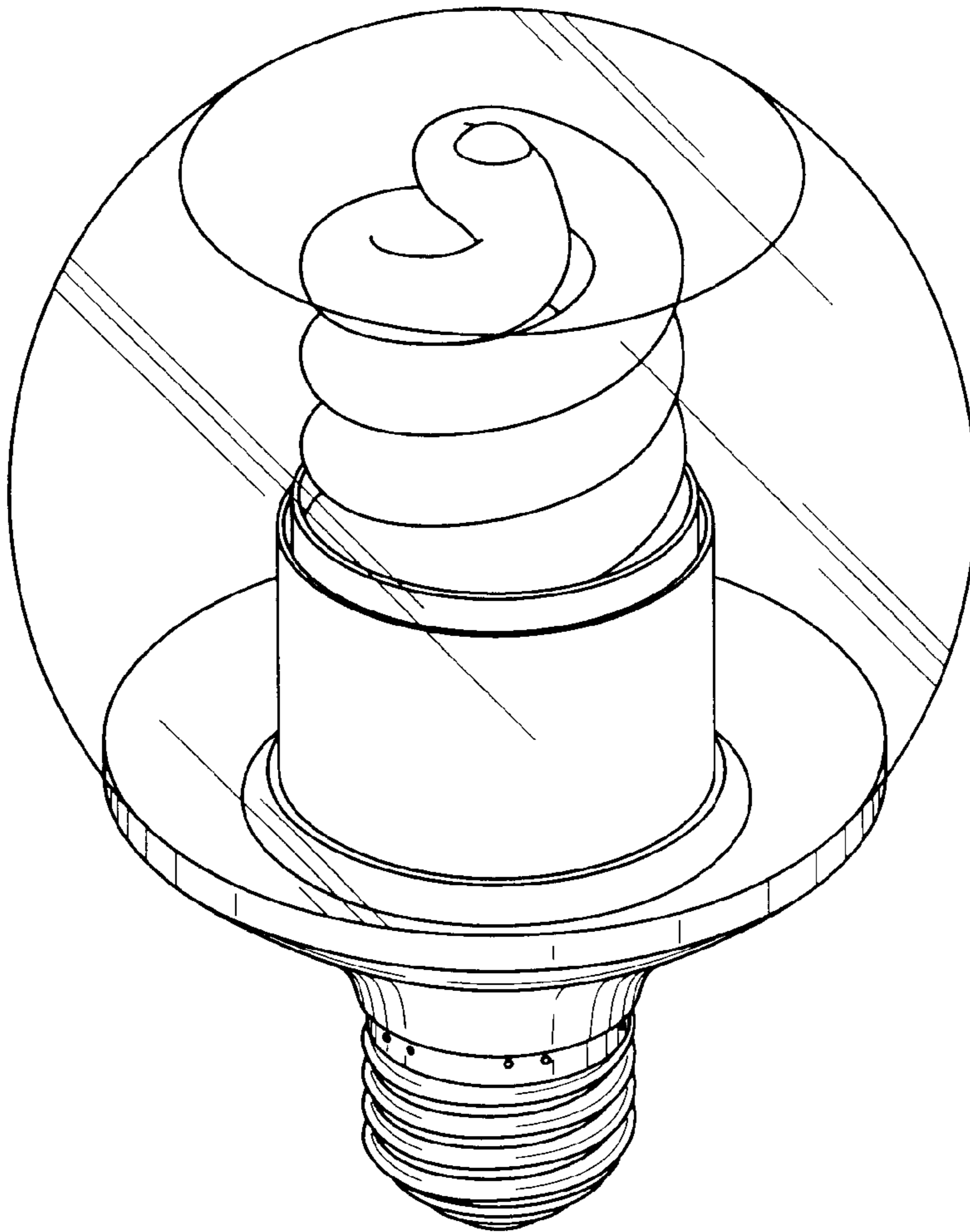

FIG. 2

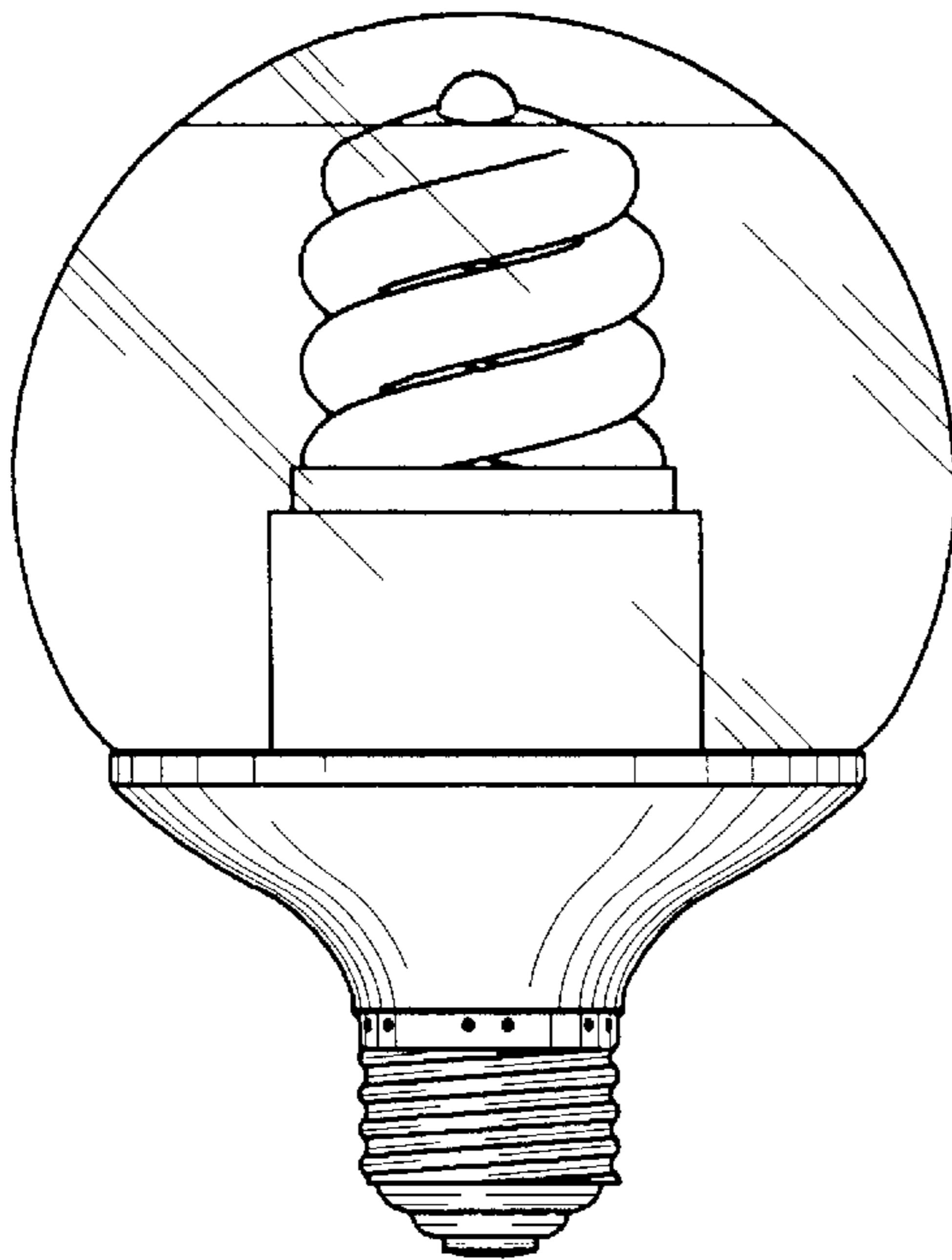

FIG. 3

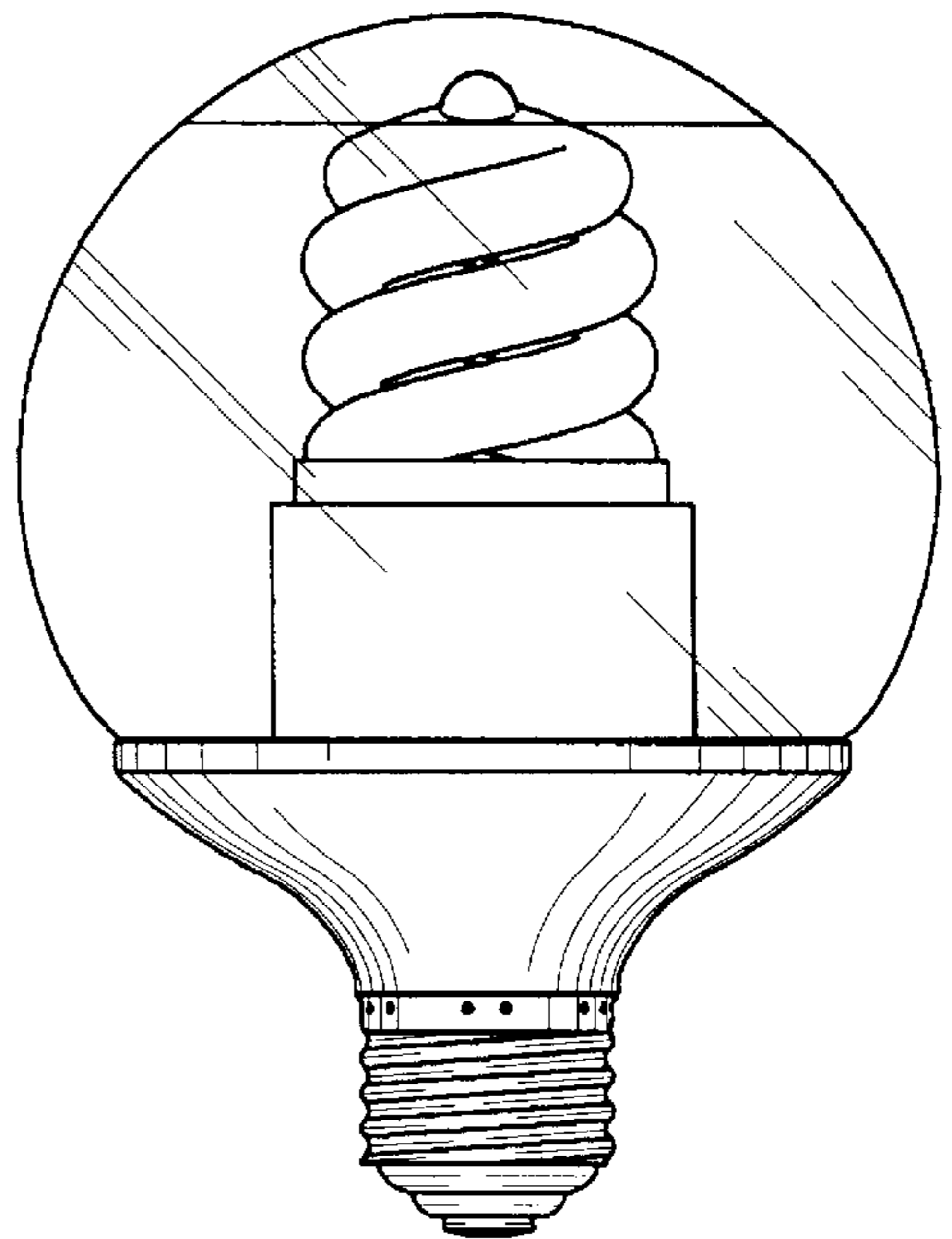

FIG. 4

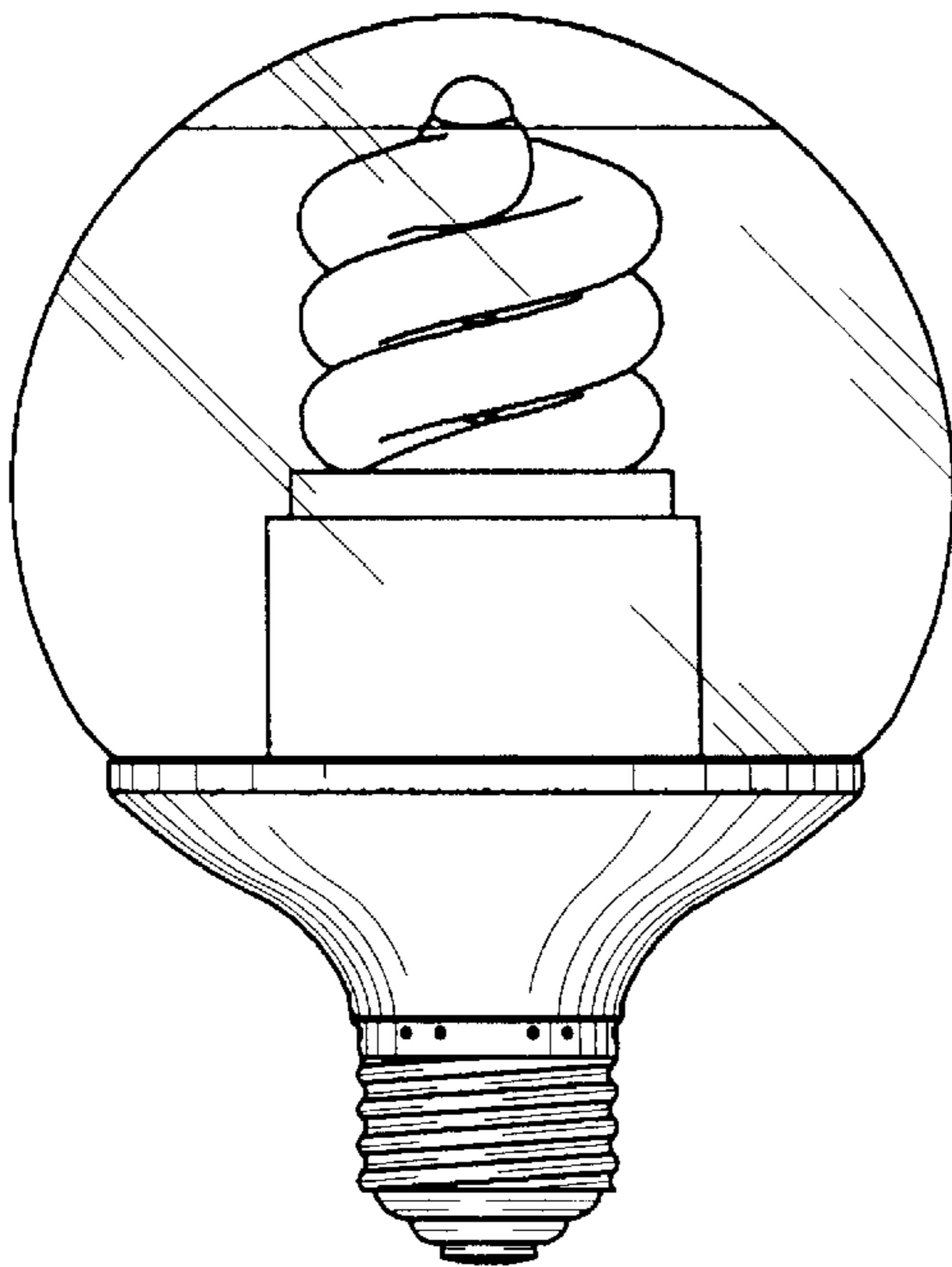

FIG. 5

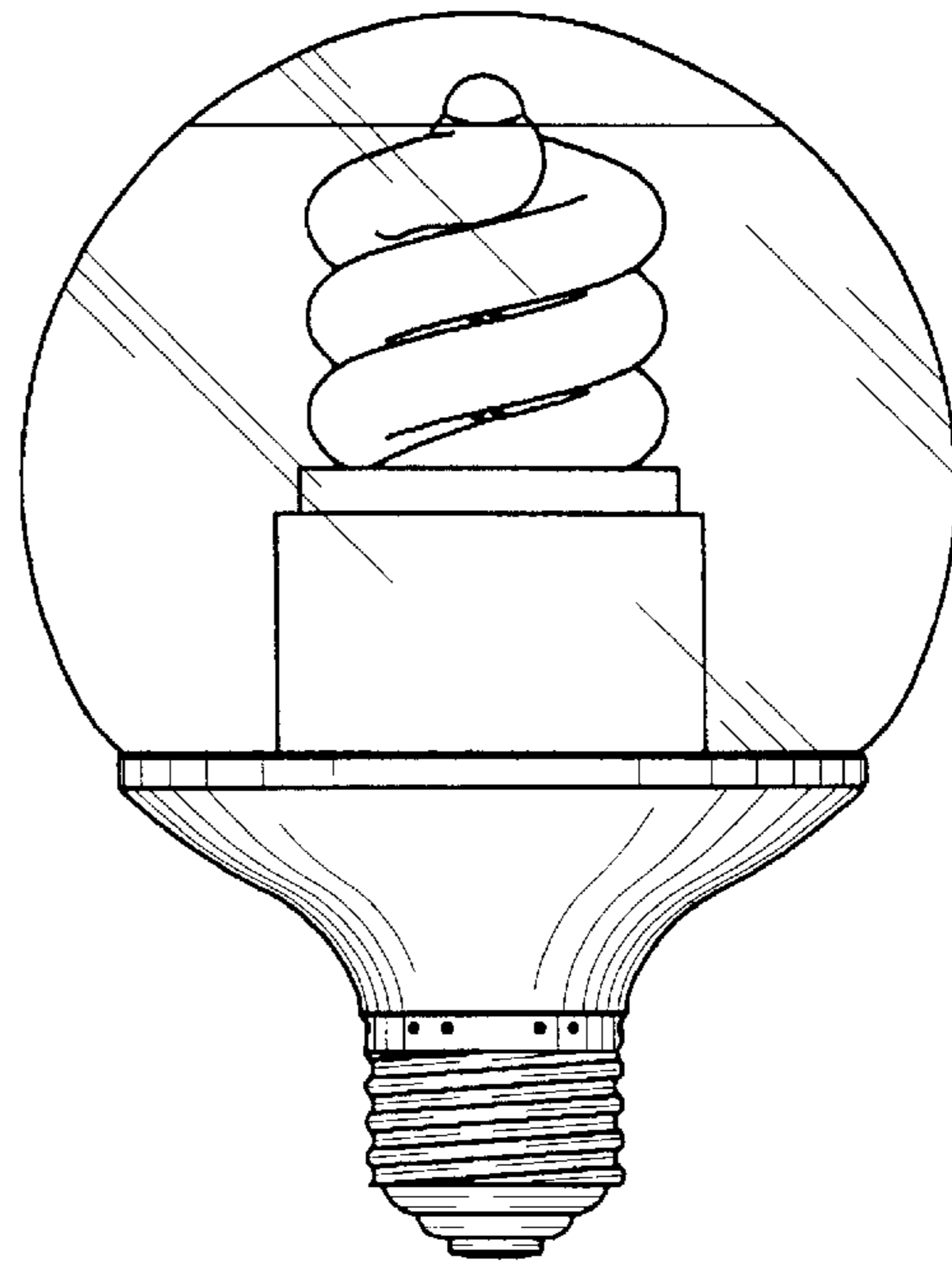

FIG. 6

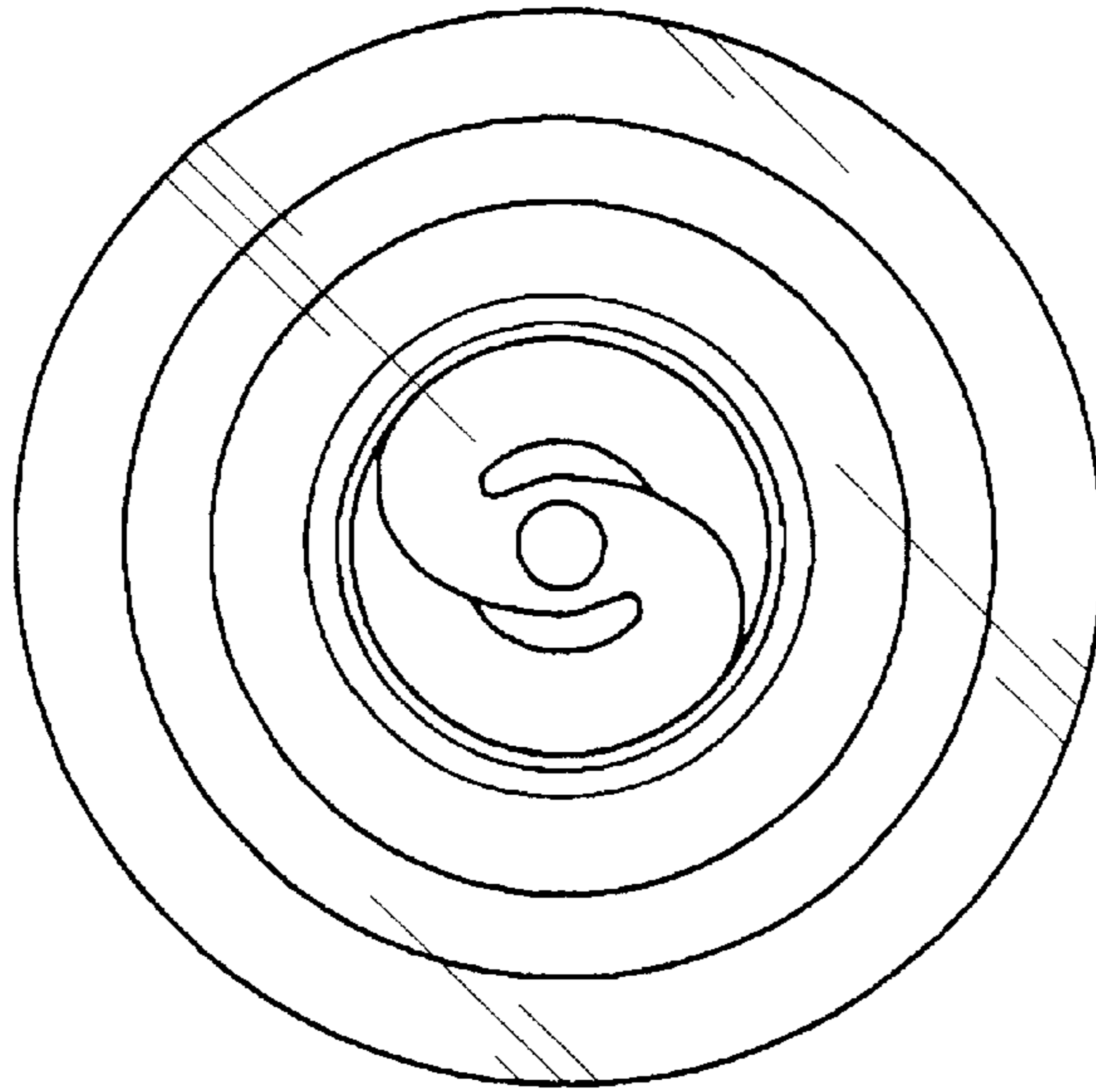

FIG. 7

