



US00D479257S

(12) **United States Design Patent**
Smith et al.

(10) **Patent No.:** **US D479,257 S**

(45) **Date of Patent:** **** Sep. 2, 2003**

(54) **UNDERWATER HOUSING ASSEMBLY**

(75) Inventors: **Stephen J. Smith**, Shortsville, NY (US); **Wayne E. Stiehler**, Spencerport, NY (US); **Edwin J. Khang**, Redondo Beach, CA (US); **Jeffrey S. Eng**, Willington, NC (US)

(73) Assignee: **Eastman Kodak Company**, Rochester, NY (US)

(**) Term: **14 Years**

(21) Appl. No.: **29/153,013**

(22) Filed: **Dec. 21, 2001**

(51) **LOC (7) Cl.** **16-01**

(52) **U.S. Cl.** **D16/204**

(58) **Field of Search** D16/200-205, D16/208, 218; D3/219, 267; 206/316.1, 316.2; 396/25-29, 535-541

(56) **References Cited**

U.S. PATENT DOCUMENTS

D348,076 S *	6/1994	Chan	D16/218
D367,283 S *	2/1996	Lyon et al.	D16/208
D394,869 S *	6/1998	Reibl et al.	D16/204
D438,880 S *	3/2001	Katayama	D16/204
6,377,751 B1 *	4/2002	Uchiyama	396/25
6,434,330 B1 *	8/2002	Uchiyama et al.	396/27

* cited by examiner

Primary Examiner—Adir Aronovich

(74) *Attorney, Agent, or Firm*—Robert Luke Walker

(57) **CLAIM**

The ornamental design for a underwater housing assembly, as shown and described.

DESCRIPTION

FIG. 1 is a front perspective view of the underwater housing assembly.

FIG. 2 is a rear perspective view of the underwater housing assembly.

FIG. 3 is a front view of the underwater housing assembly.

FIG. 4 is a rear view of the underwater housing assembly.

FIG. 5 is a top view of the underwater housing assembly.

FIG. 6 is a bottom view of the underwater housing assembly.

FIG. 7 is a right side view of the underwater housing assembly.

FIG. 8 is a left side view of the underwater housing assembly; and,

FIG. 9 is a front view of the underwater housing assembly showing, in phantom lines, a camera assembly enclosed within the underwater housing assembly.

The portions of the article in broken lines are shown for illustrative purposes only and form no part of the claimed design.

1 Claim, 9 Drawing Sheets

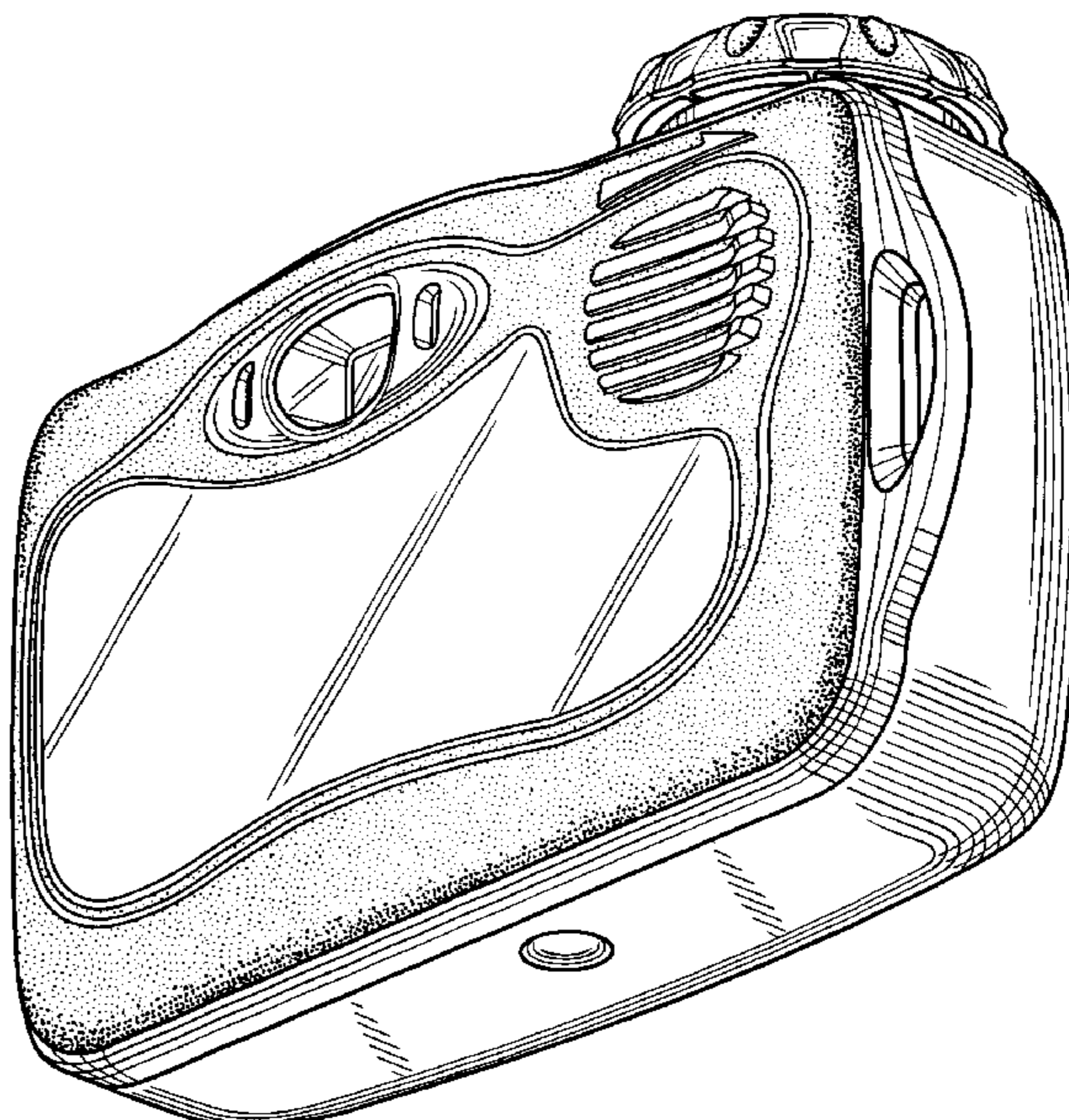
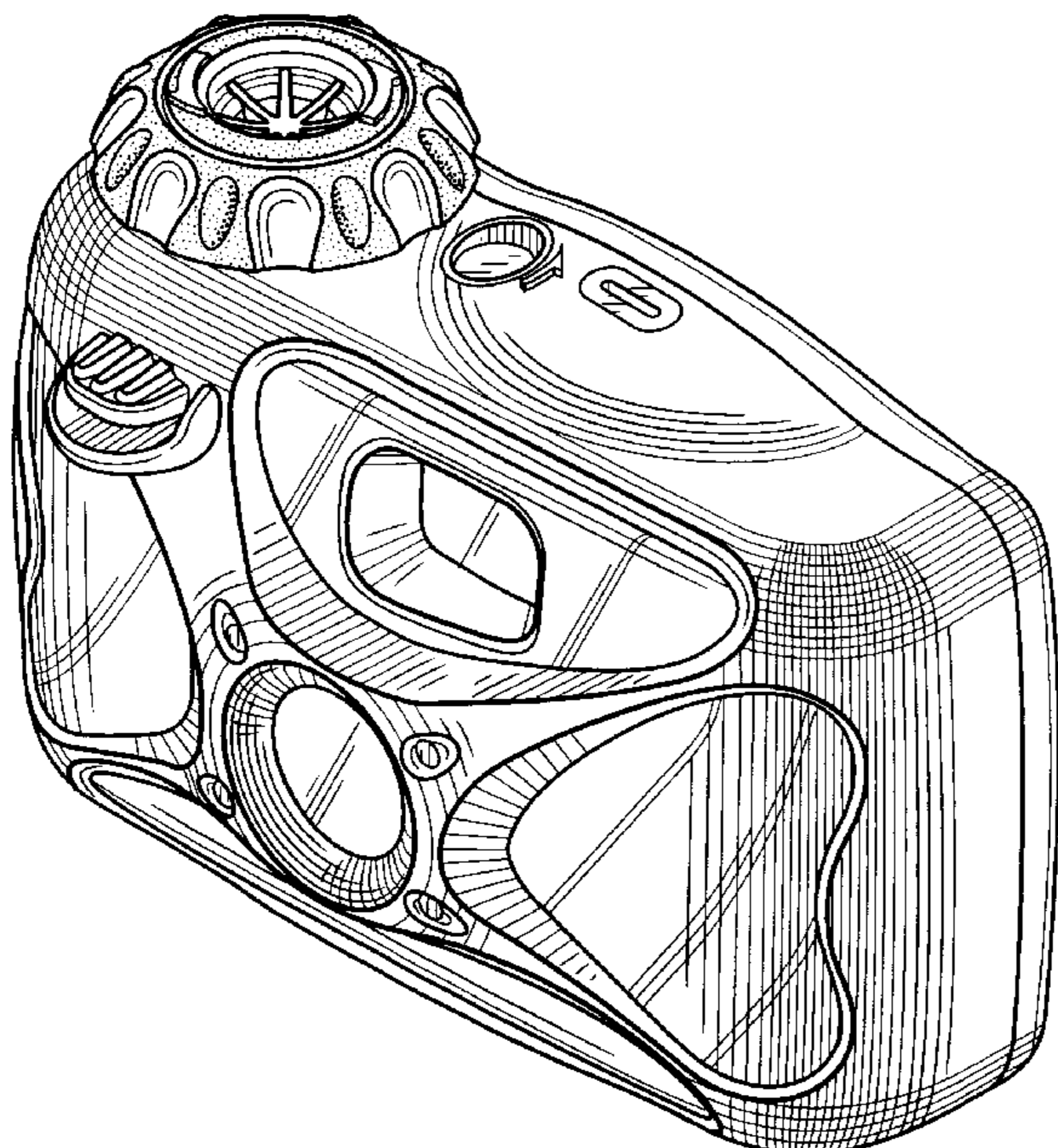

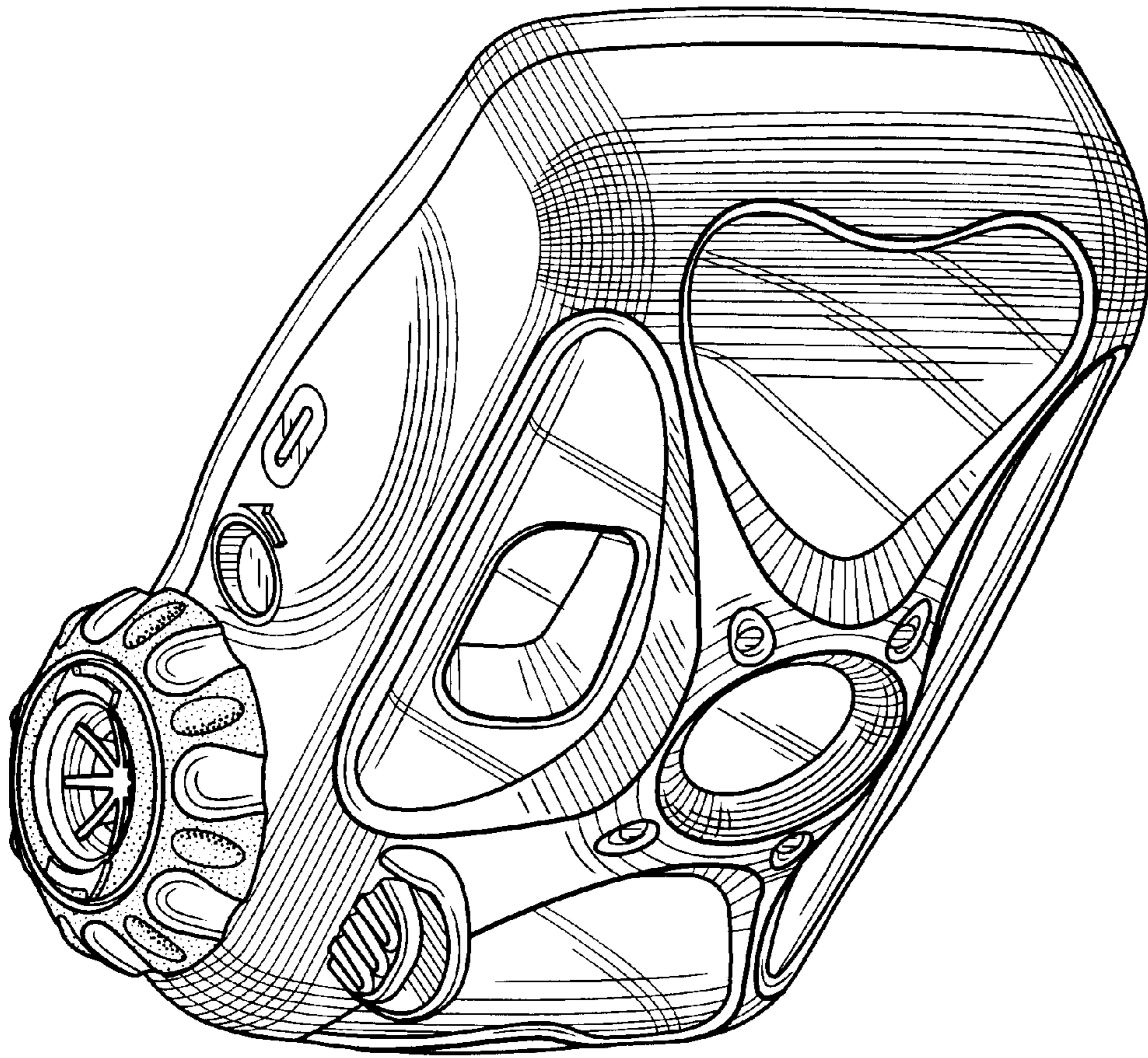

FIG. 1

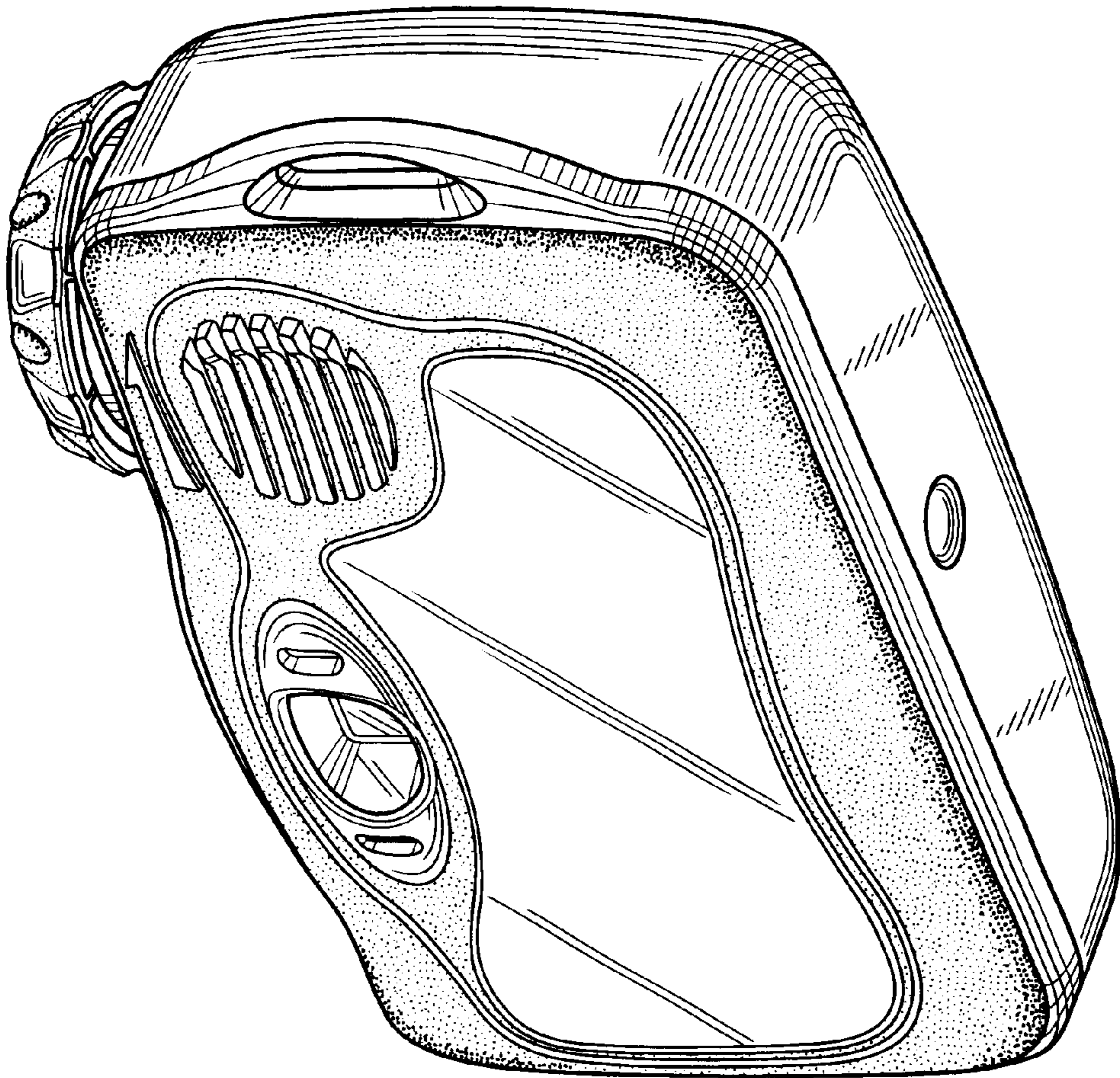

FIG. 2

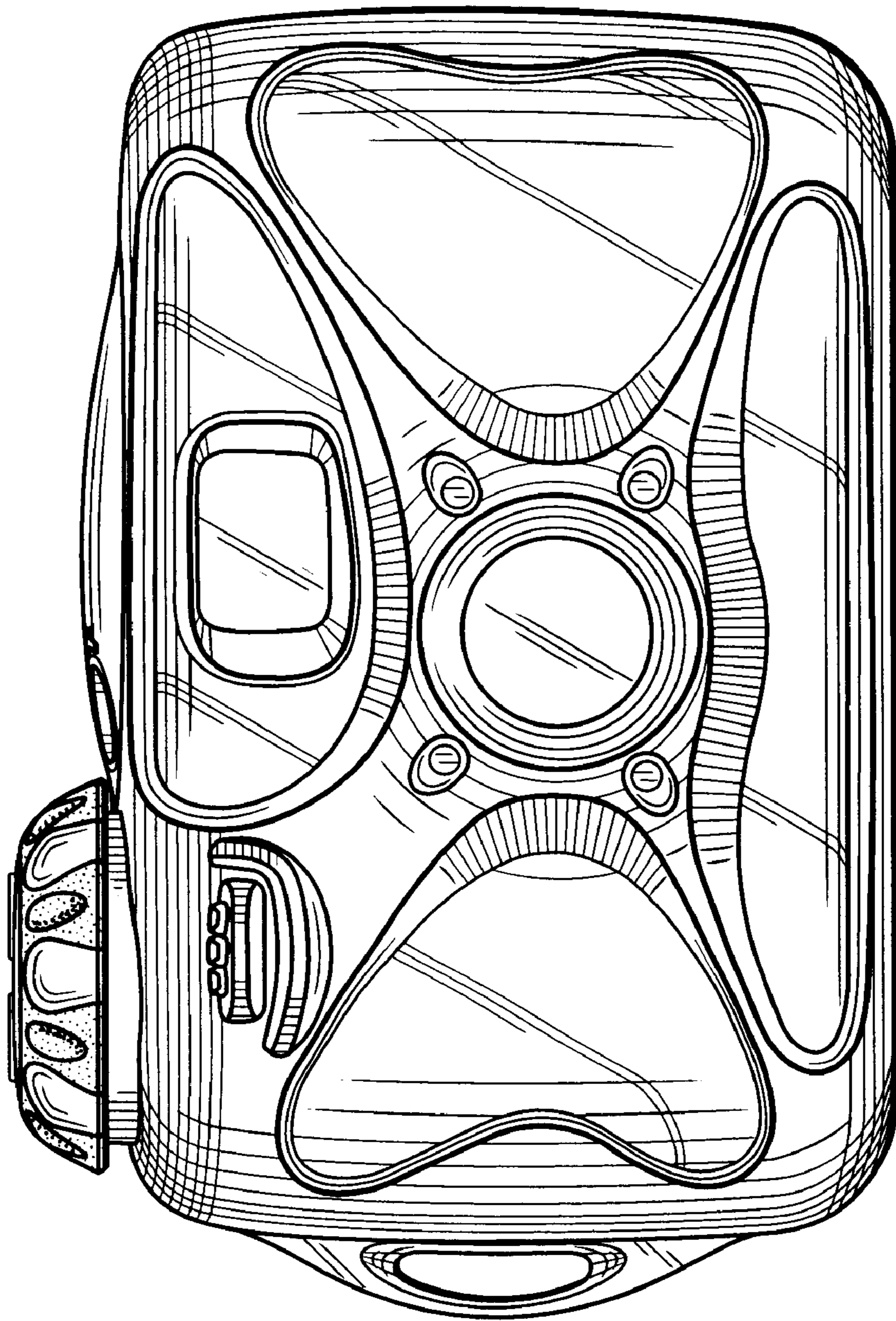

FIG. 3

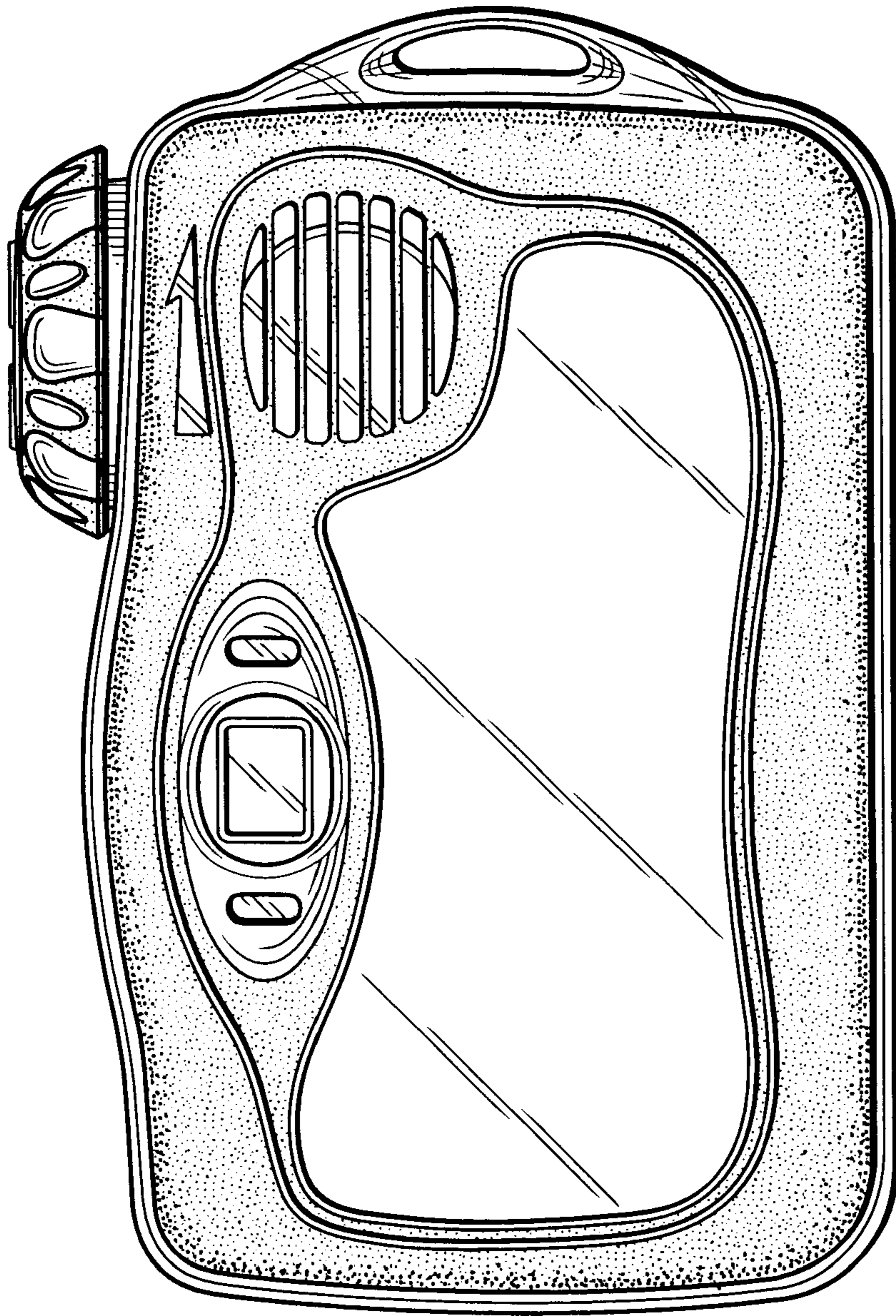

FIG. 4

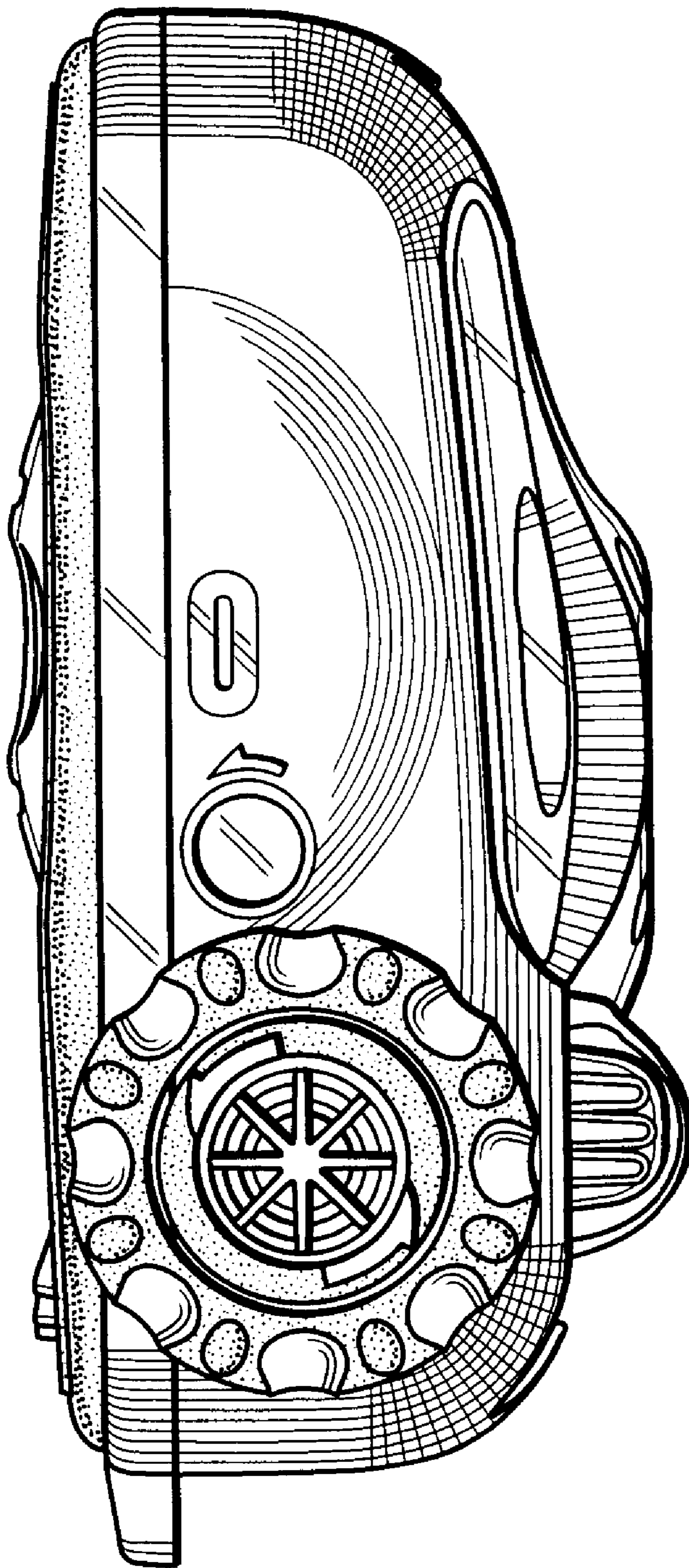

FIG. 5

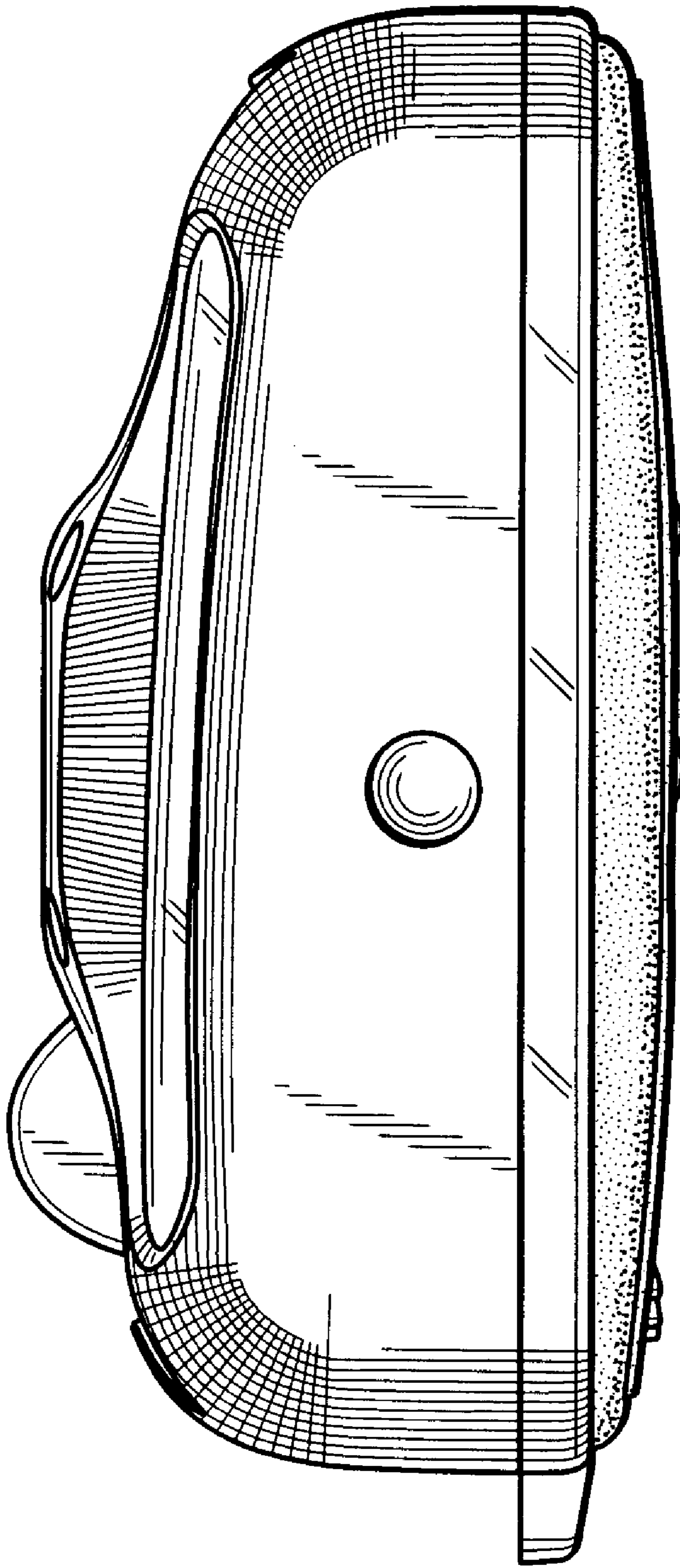

FIG. 6

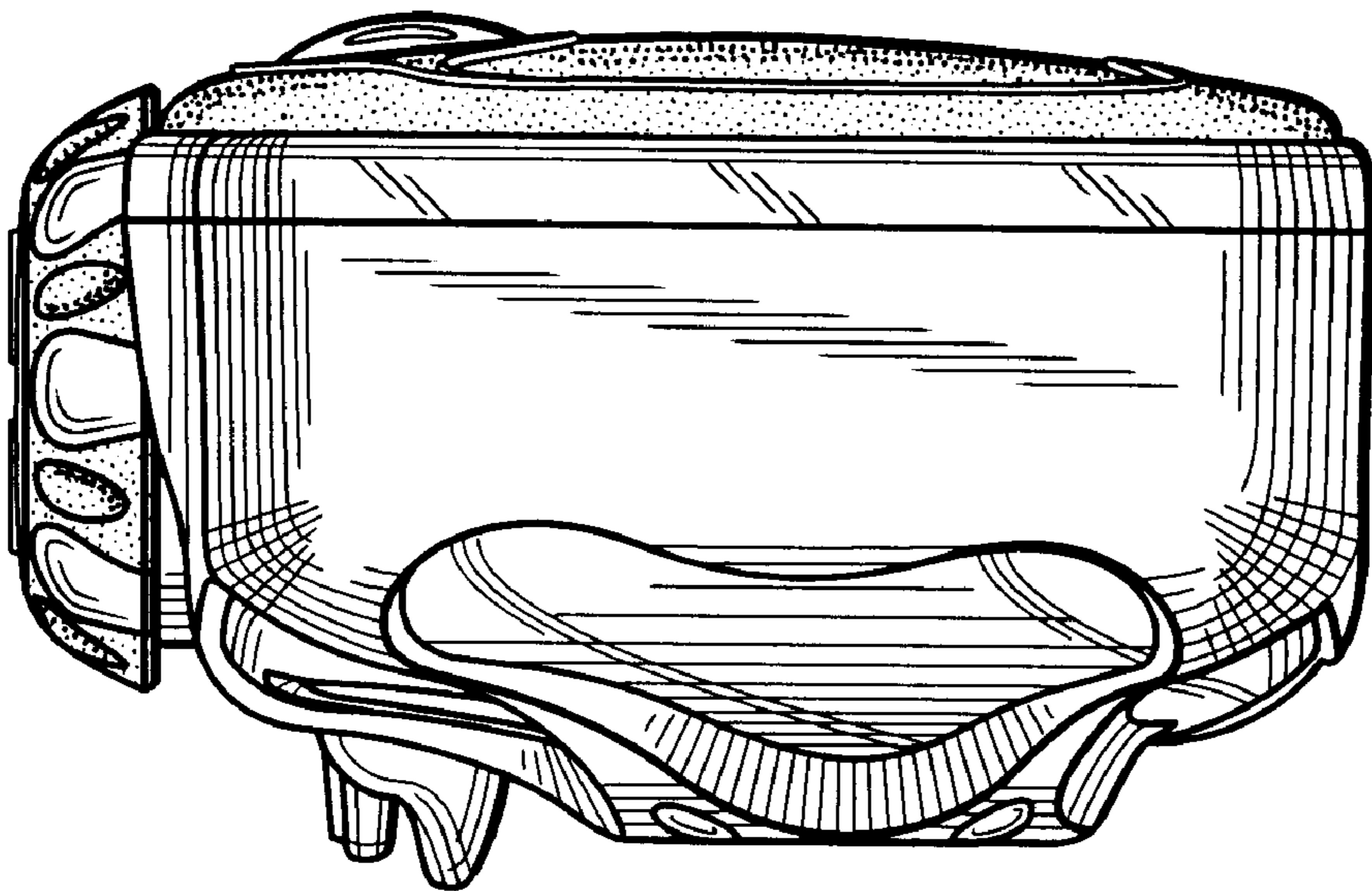

FIG. 7

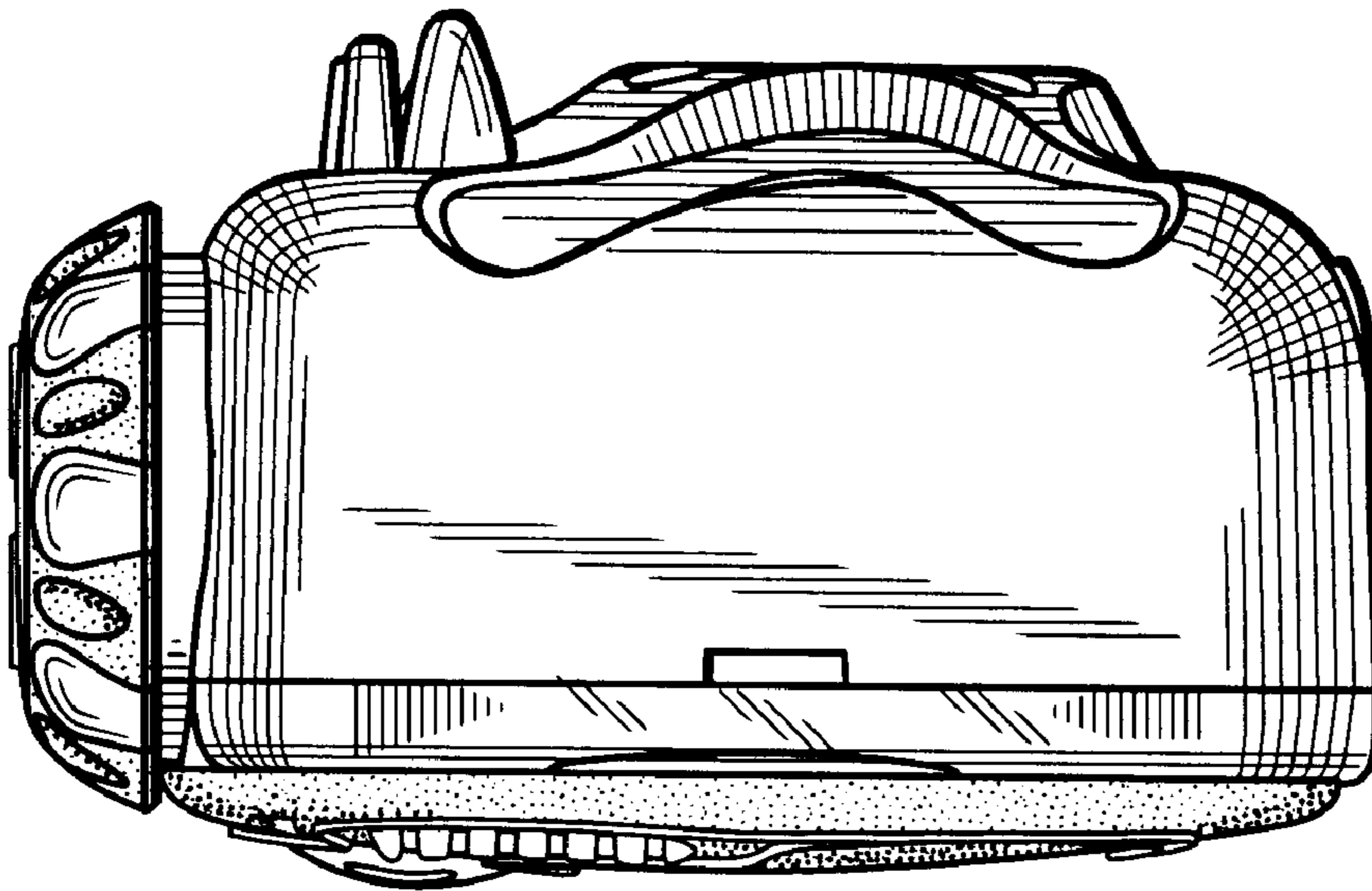

FIG. 8

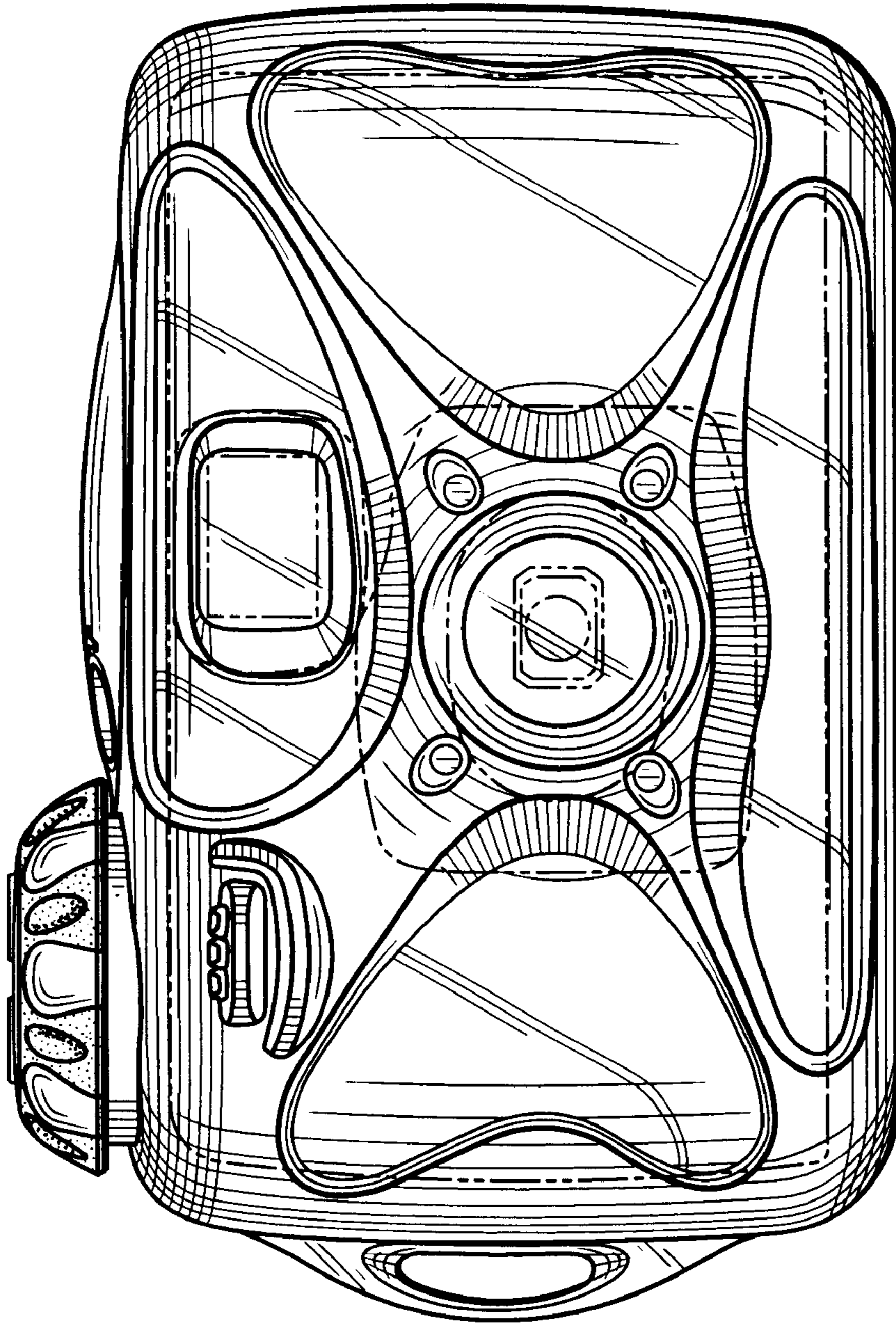

FIG. 9