



US00D479218S

(12) **United States Design Patent**
Christianson

(10) **Patent No.:** **US D479,218 S**

(45) **Date of Patent:** **** Sep. 2, 2003**

(54) **DVD/CD PLAYER AND SOUND GENERATOR**

(75) Inventor: **Tristan M. Christianson**, San Francisco, CA (US)

(73) Assignee: **Sharper Image Corporation**, San Francisco, CA (US)

(**) Term: **14 Years**

(21) Appl. No.: **29/168,427**

(22) Filed: **Oct. 1, 2002**

(51) **LOC (7) Cl.** **14-01**

(52) **U.S. Cl.** **D14/168; D14/156**

(58) **Field of Search** D14/135-136,
D14/156-157, 167-168, 188, 193-198,
257-258, 132; 369/75.1, 75.2, 77.1, 77.2;
455/344, 347, 350-351

(56) **References Cited**

U.S. PATENT DOCUMENTS

5,265,083 A	*	11/1993	Ishii et al.	369/75.2
D409,184 S	*	5/1999	Sakamoto et al.	D14/136
D409,606 S	*	5/1999	Syudo	D14/156
D415,761 S	*	10/1999	Pinchuk	D14/171
D424,050 S	*	5/2000	Sakamoto et al.	D14/136
D456,373 S	*	4/2002	Usami et al.	D14/136
D456,382 S	*	4/2002	Christianson	D14/168

* cited by examiner

Primary Examiner—Nanda Bondade

(74) *Attorney, Agent, or Firm*—Fliesler, Dubb, Meyer & Lovejoy LLP

(57) **CLAIM**

The ornamental design for DVD/CD player and sound generator, as shown and described.

DESCRIPTION

FIG. 1 is a front closed perspective view of a DVD/CD player and sound generator showing my new design;
 FIG. 2 is a front closed view thereof;
 FIG. 3 is a rear closed view thereof;
 FIG. 4 is a top closed view thereof;
 FIG. 5 is a bottom closed view thereof;
 FIG. 6 is a right closed side view thereof; The left closed side view is a mirror image and not shown.
 FIG. 7 is a front open perspective view thereof;
 FIG. 8 is a front open view thereof;
 FIG. 9 is a rear open view thereof;
 FIG. 10 is a top open view thereof;
 FIG. 11 is a bottom open view thereof; and,
 FIG. 12 is a right open side view thereof; The left open side view is a mirror image and not shown.
 FIGS. 1 and 7 are on a reduced scale.
 The broken line showing on FIGS. 1-12 is for illustrative purposes only and forms no part of the claimed design.

1 Claim, 11 Drawing Sheets

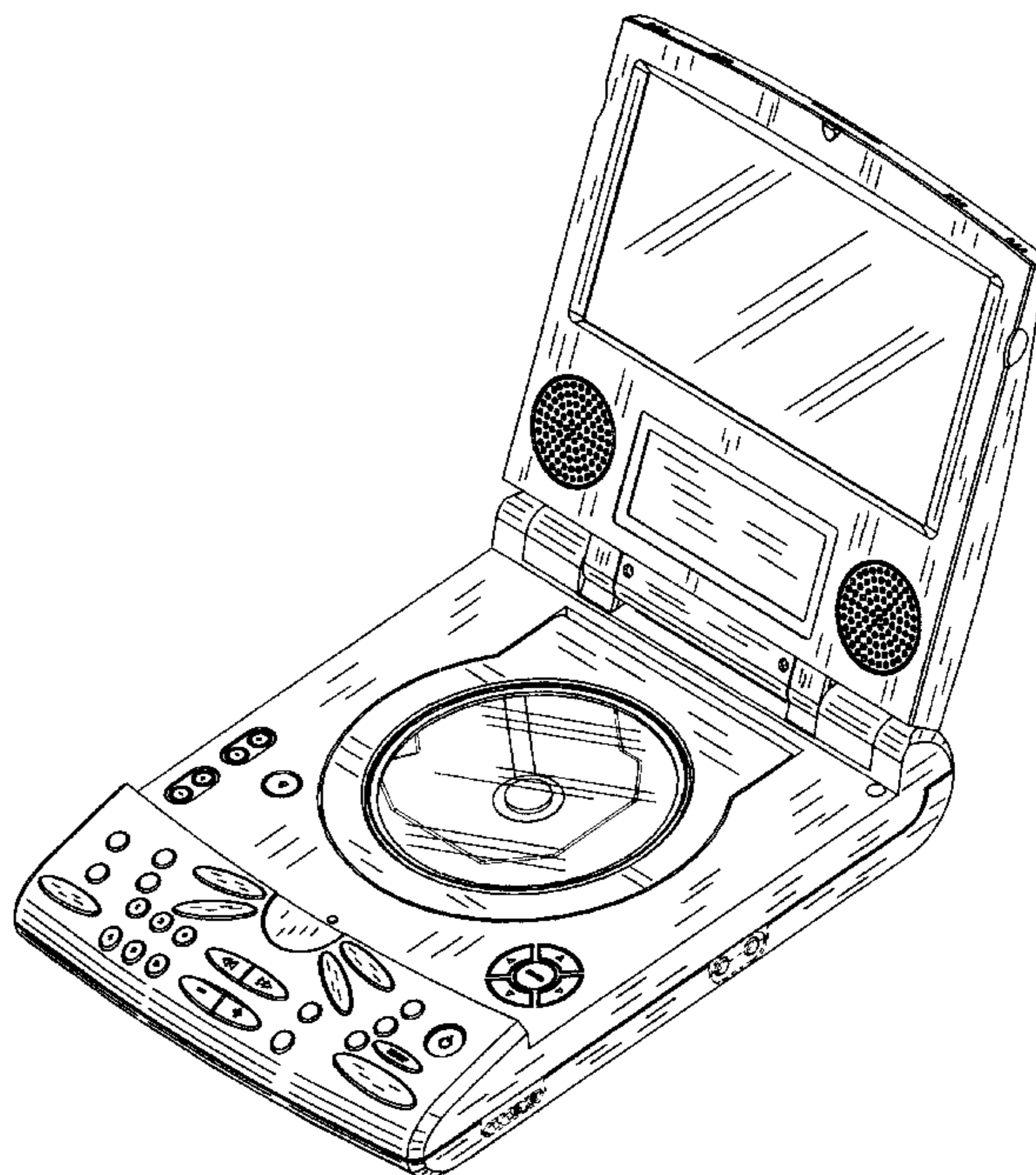
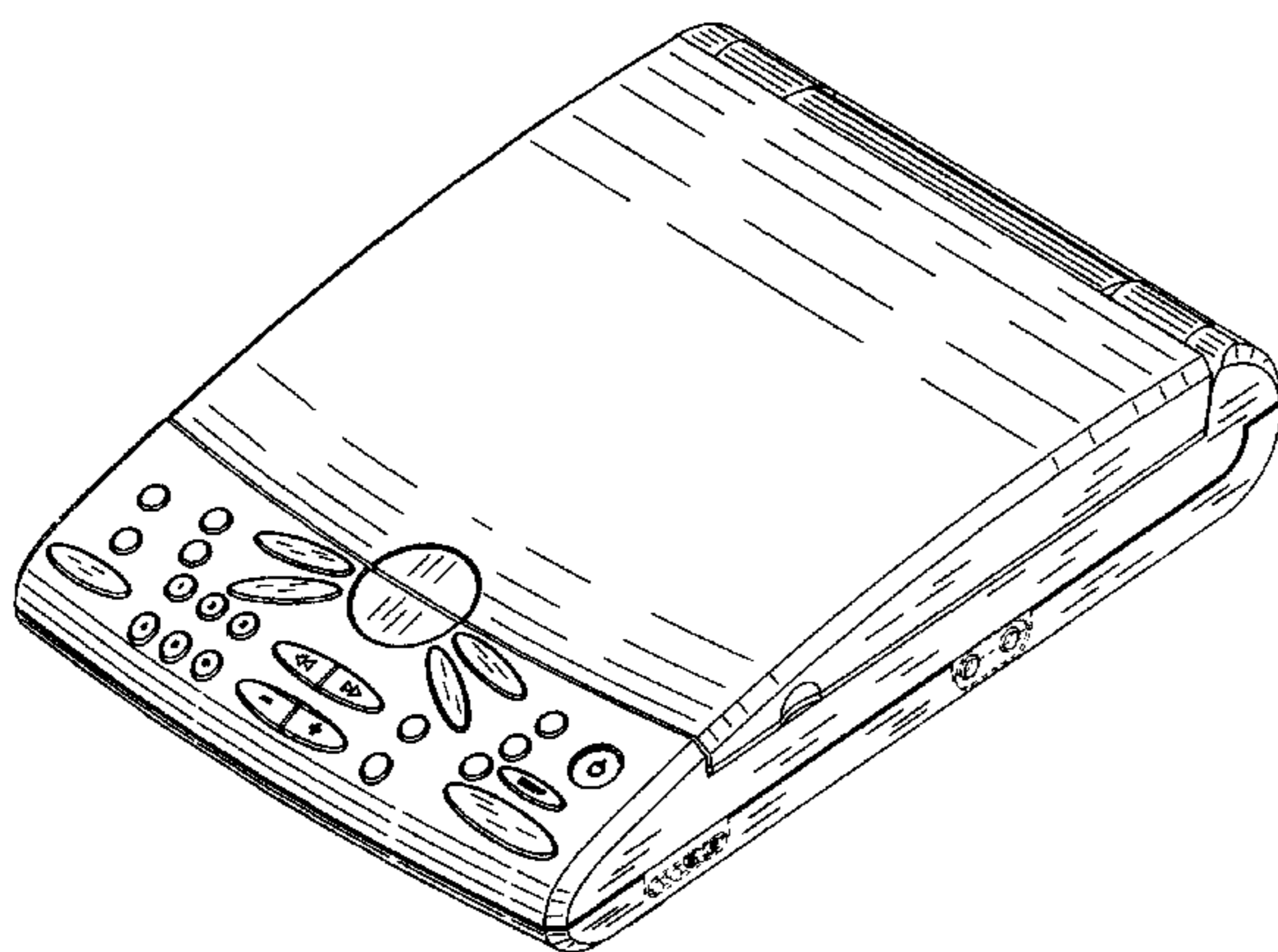

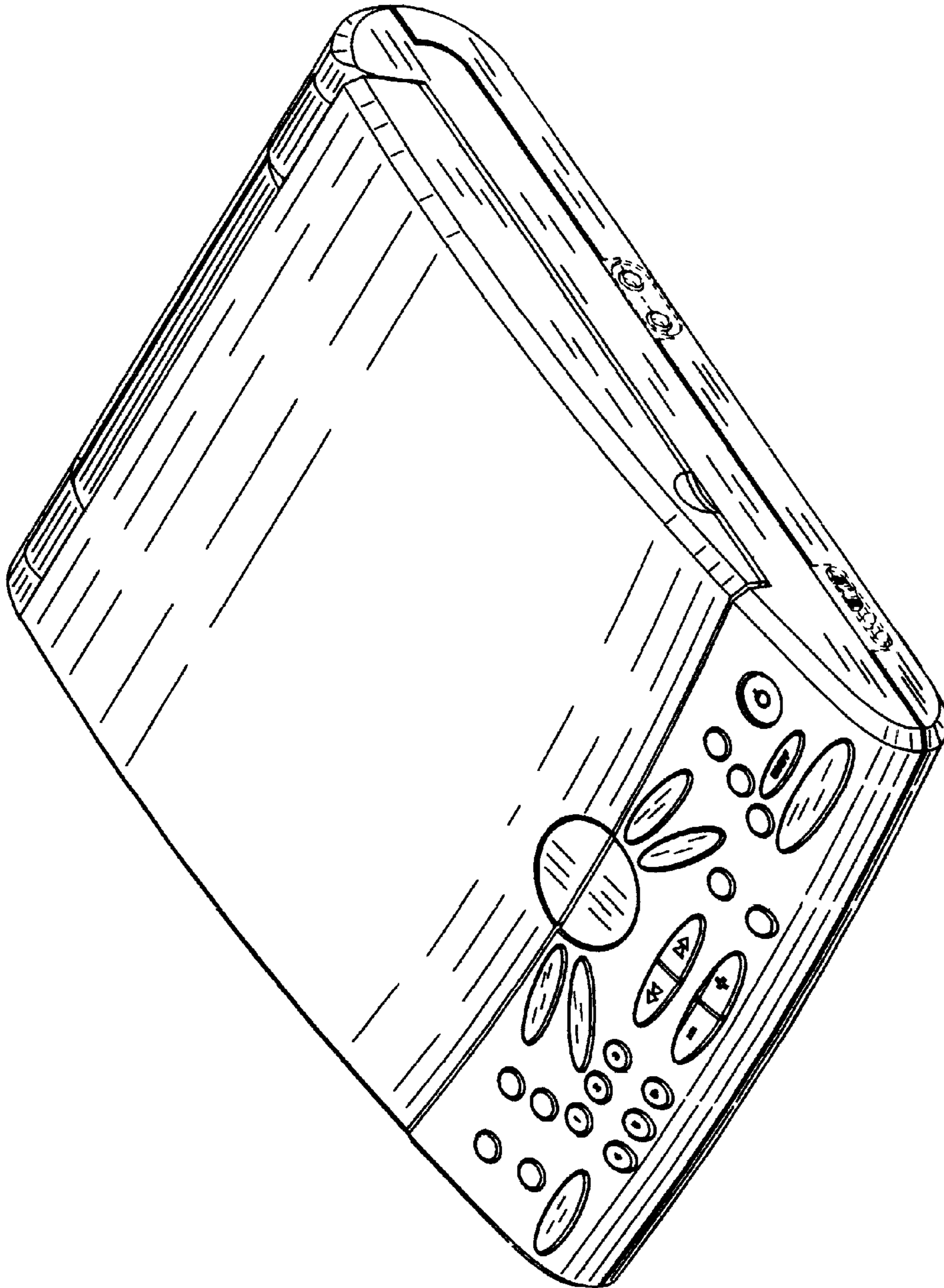

FIG. - 1

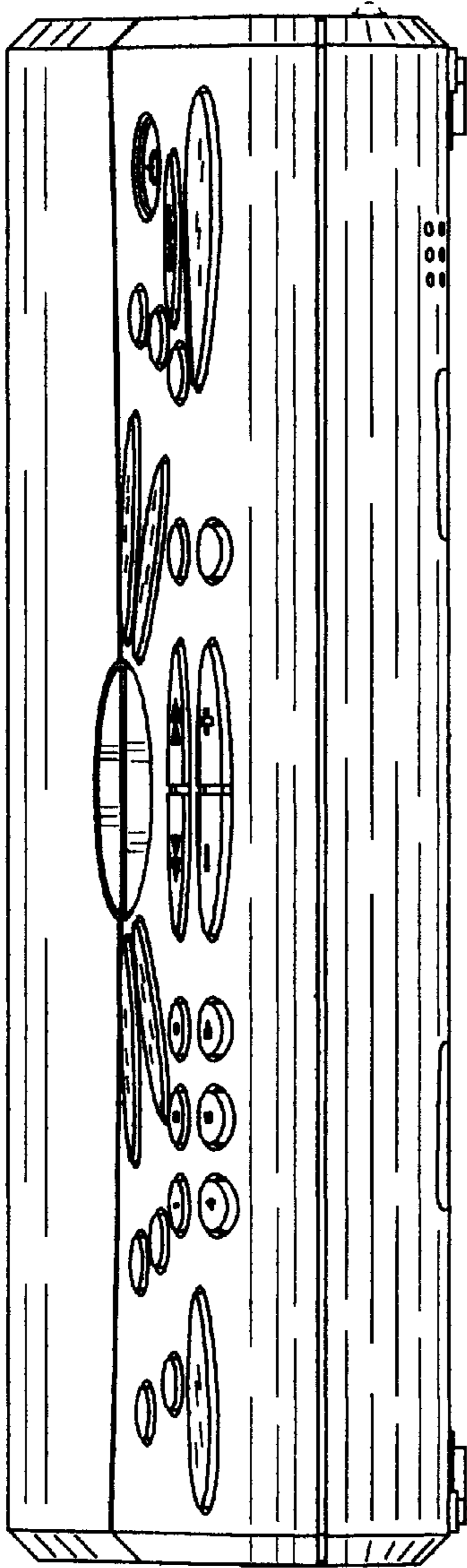

FIG. - 2

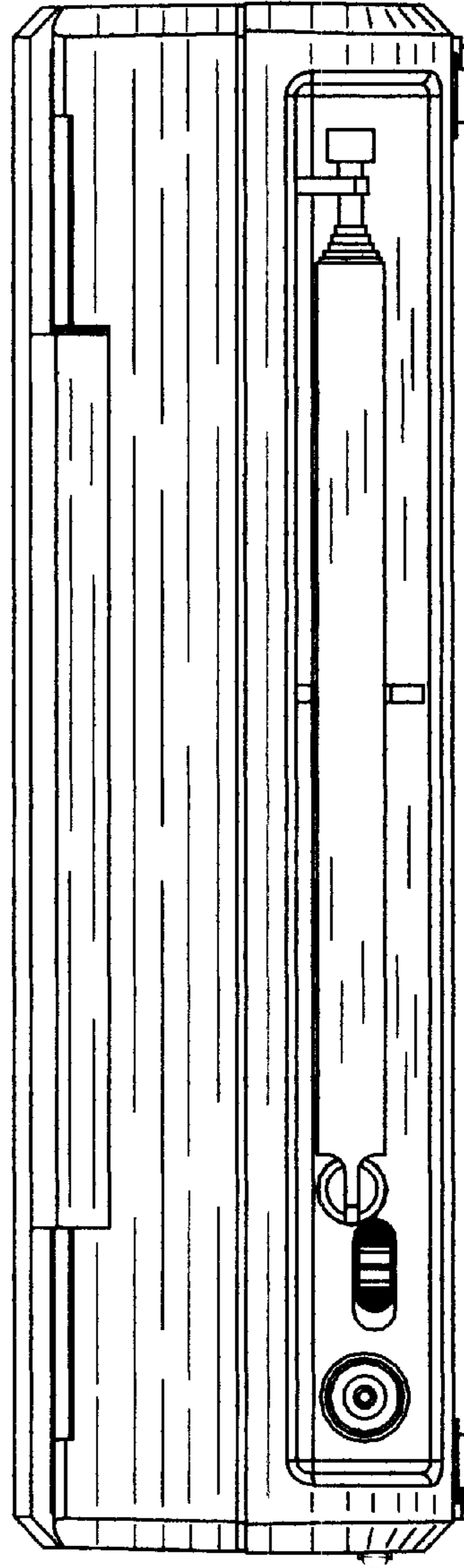

FIG. - 3

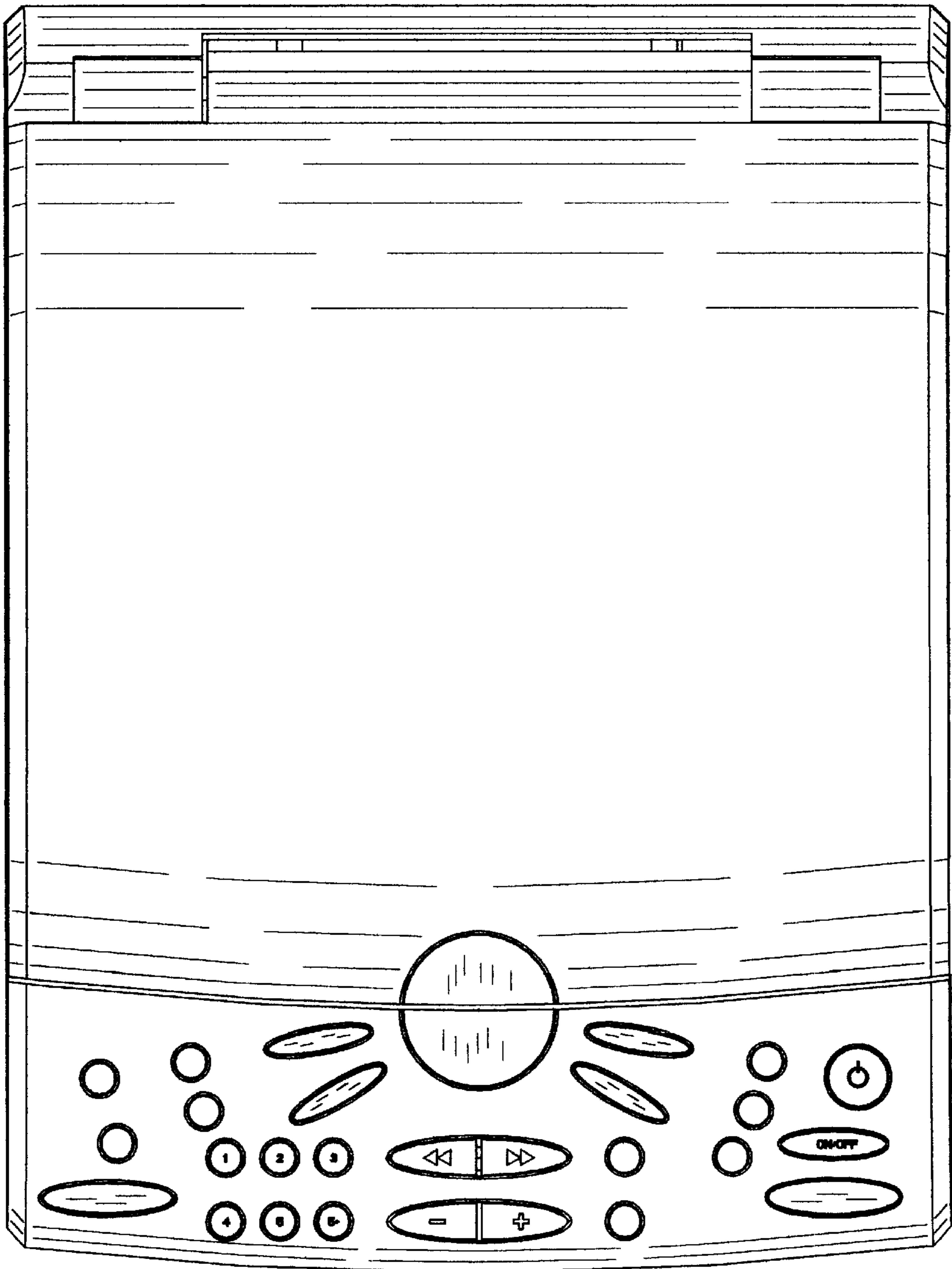

FIG. - 4

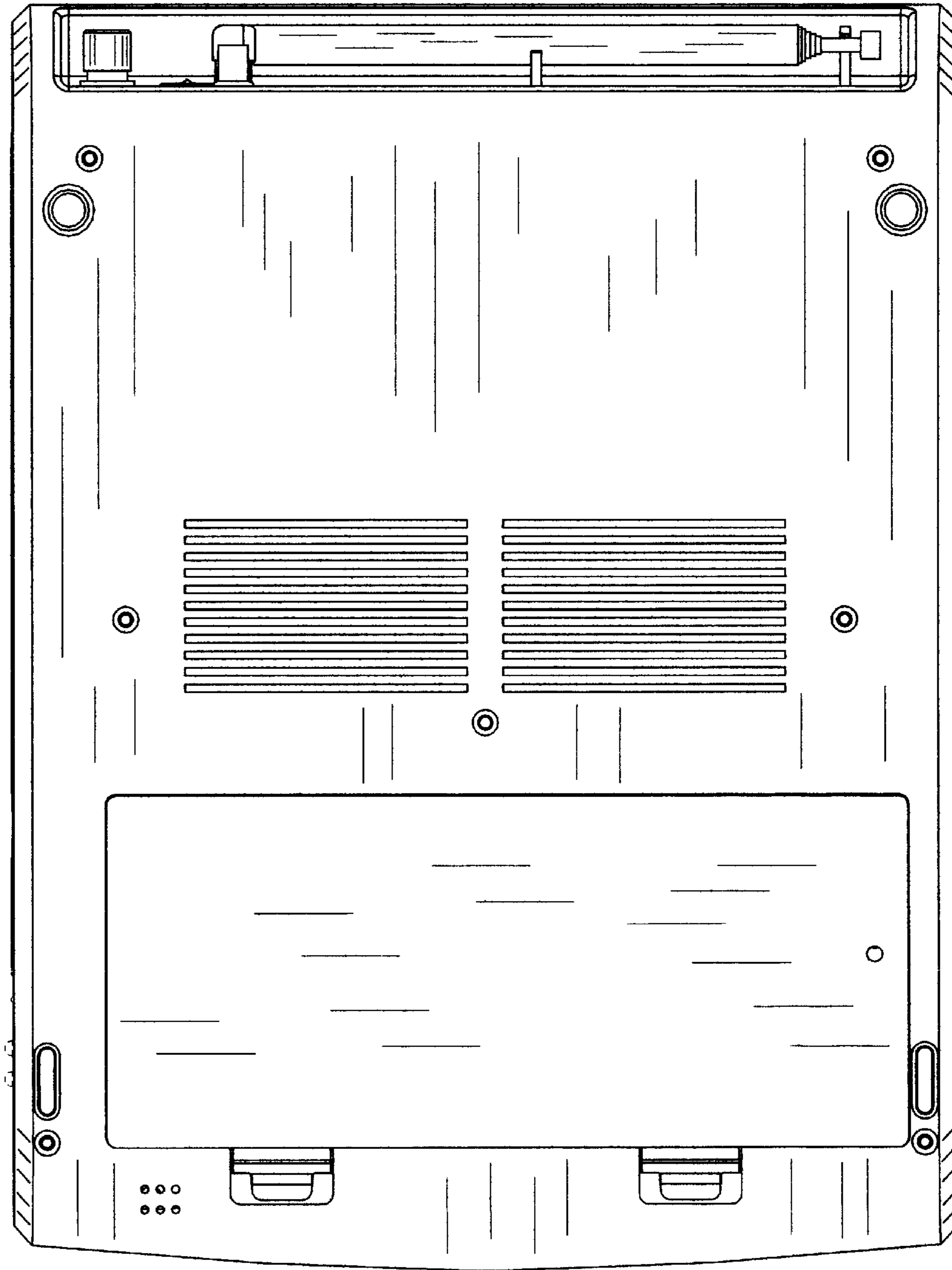

FIG. - 5

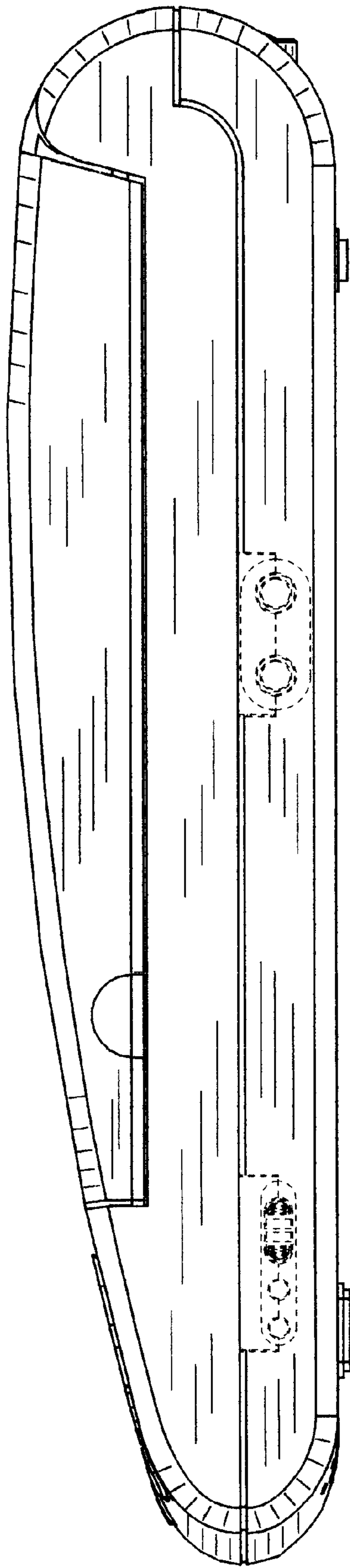

FIG. - 6

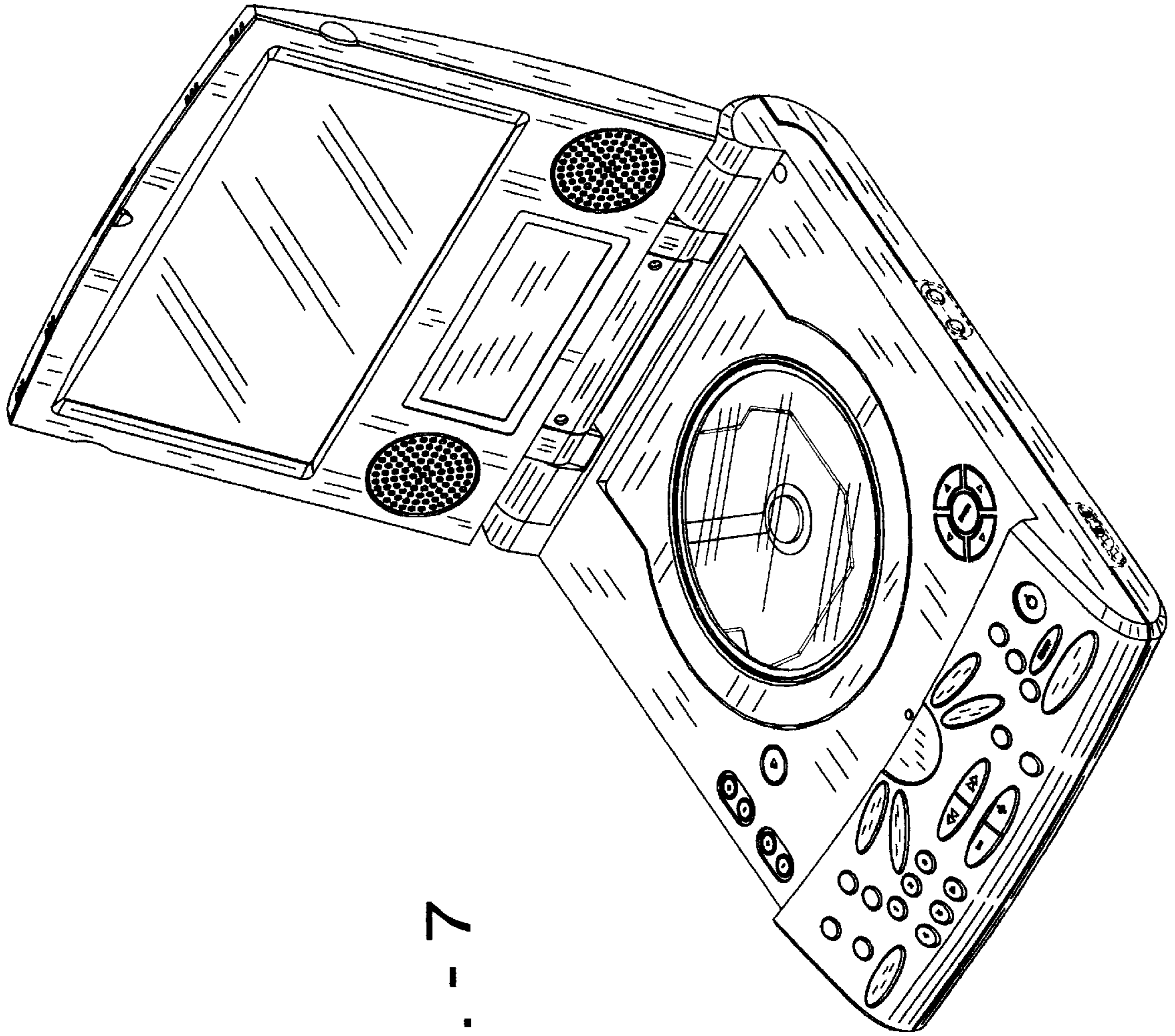

FIG. - 7

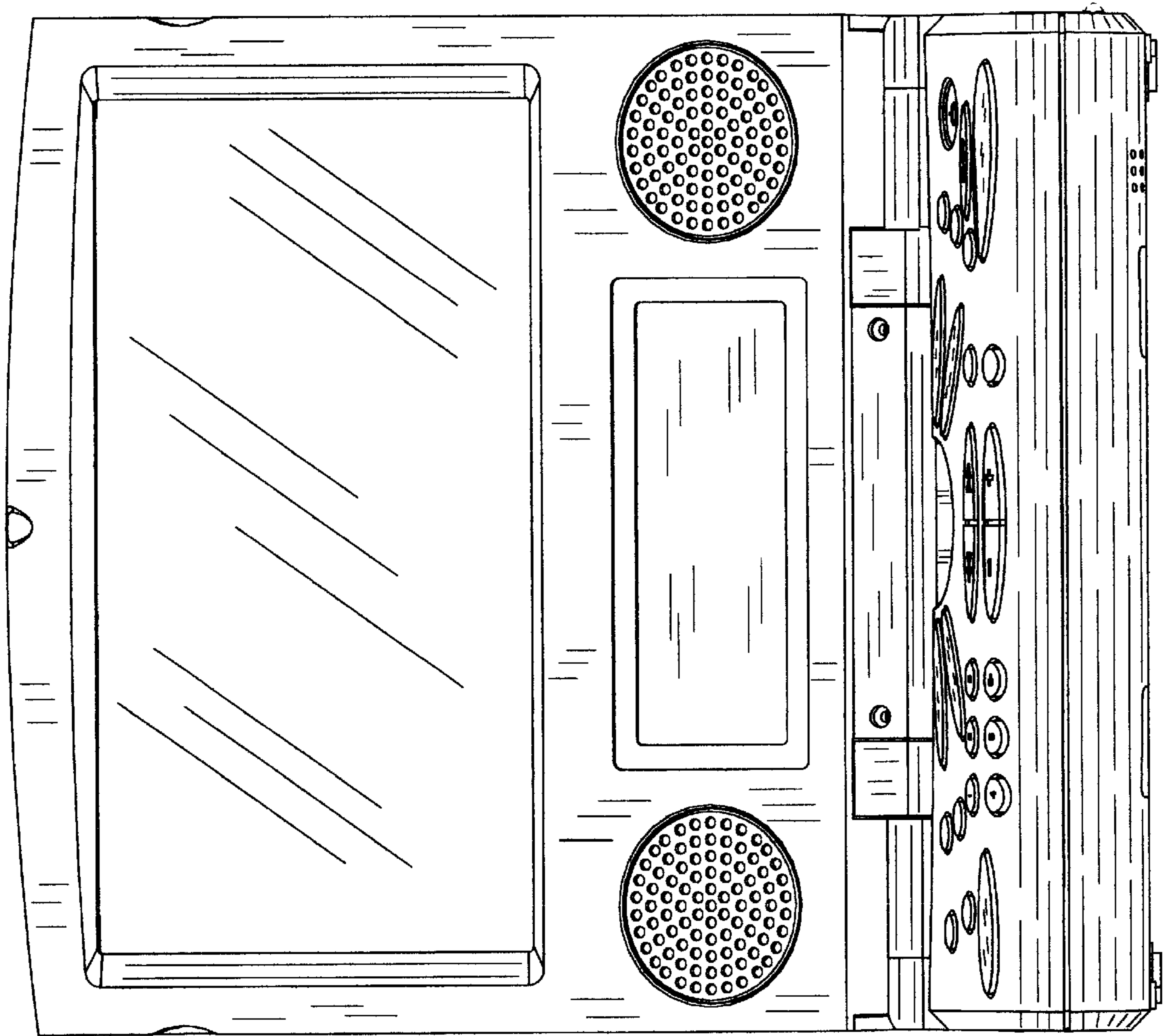

FIG. - 8

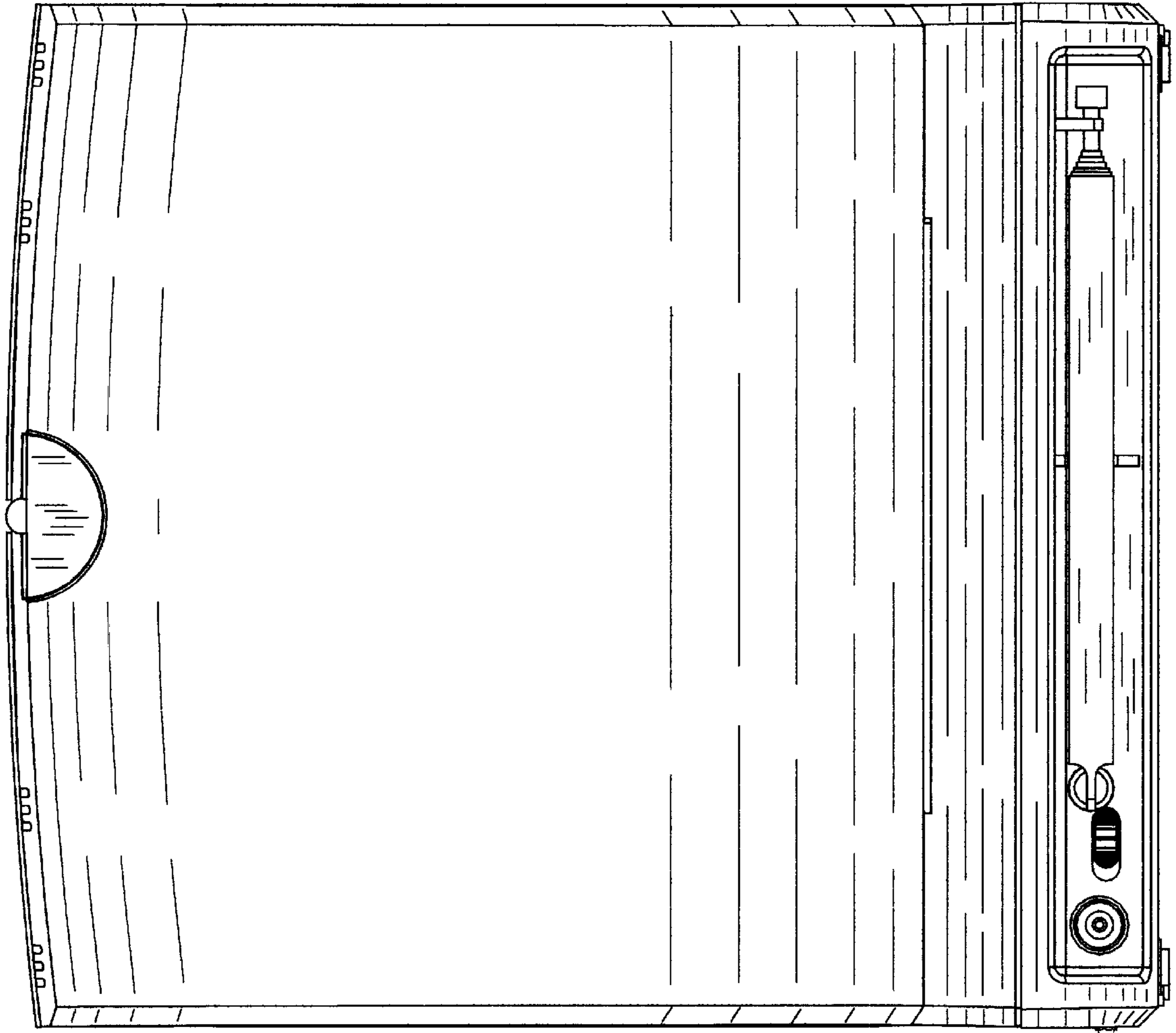

FIG. - 9

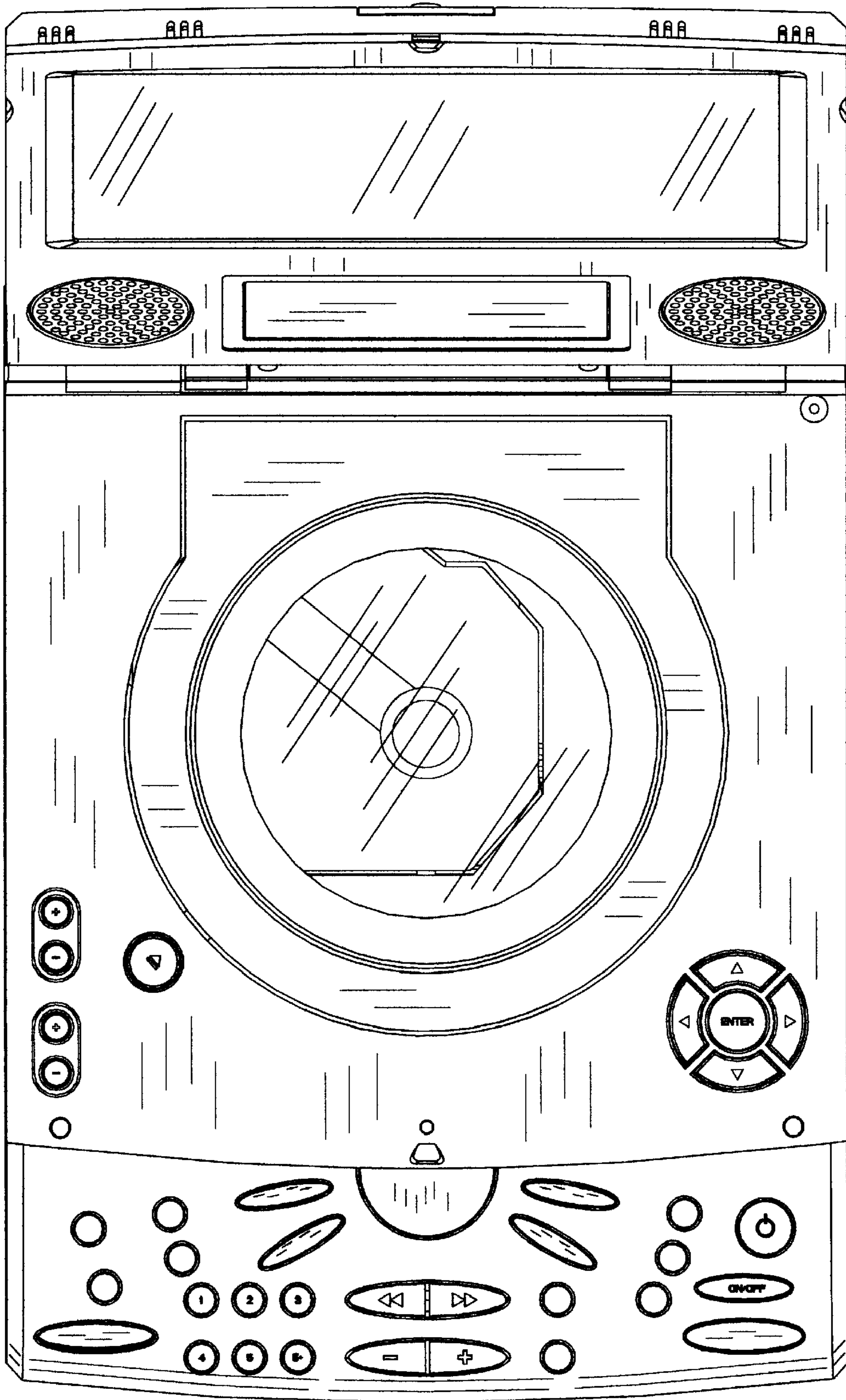

FIG. - 10

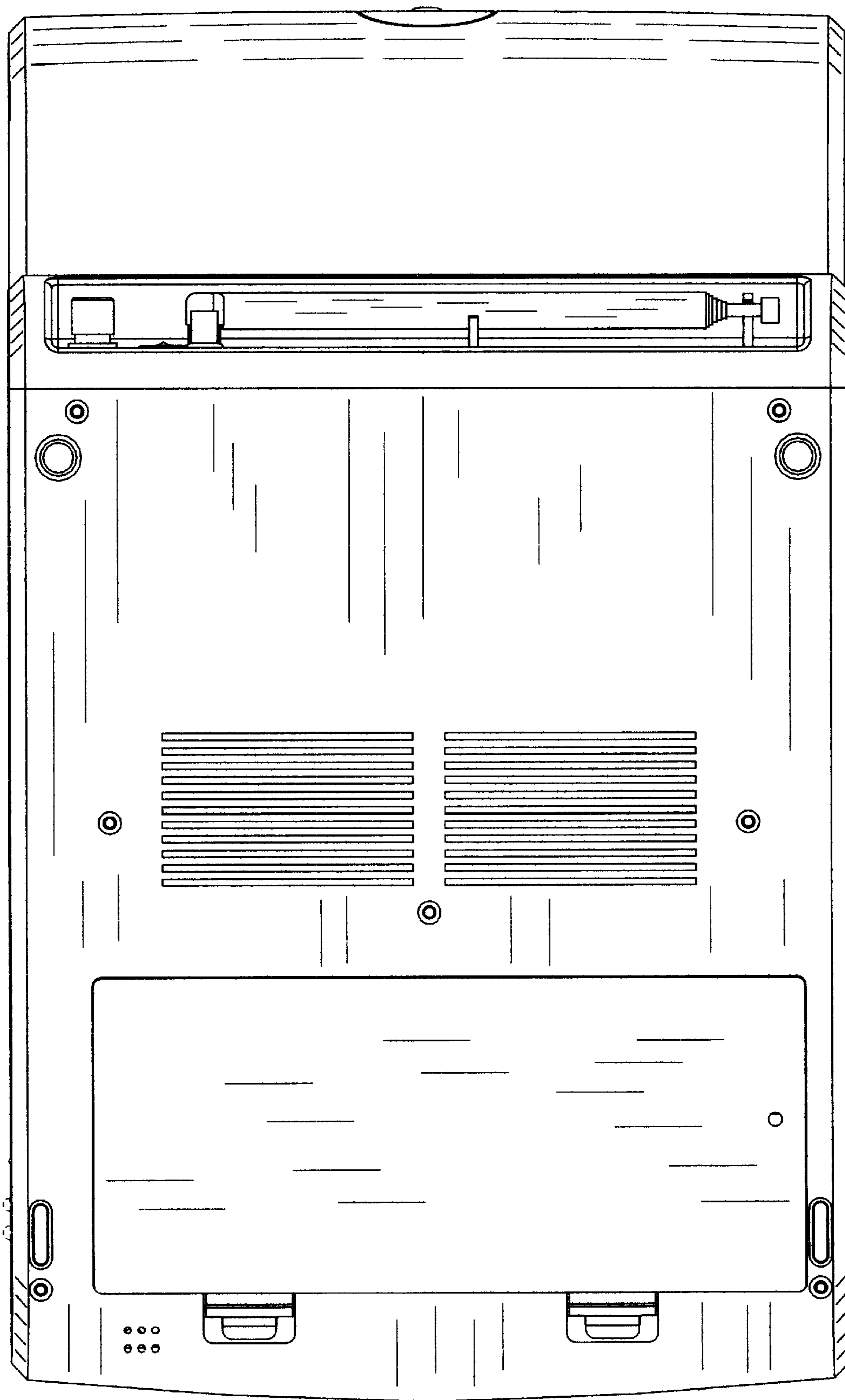

FIG. - 11

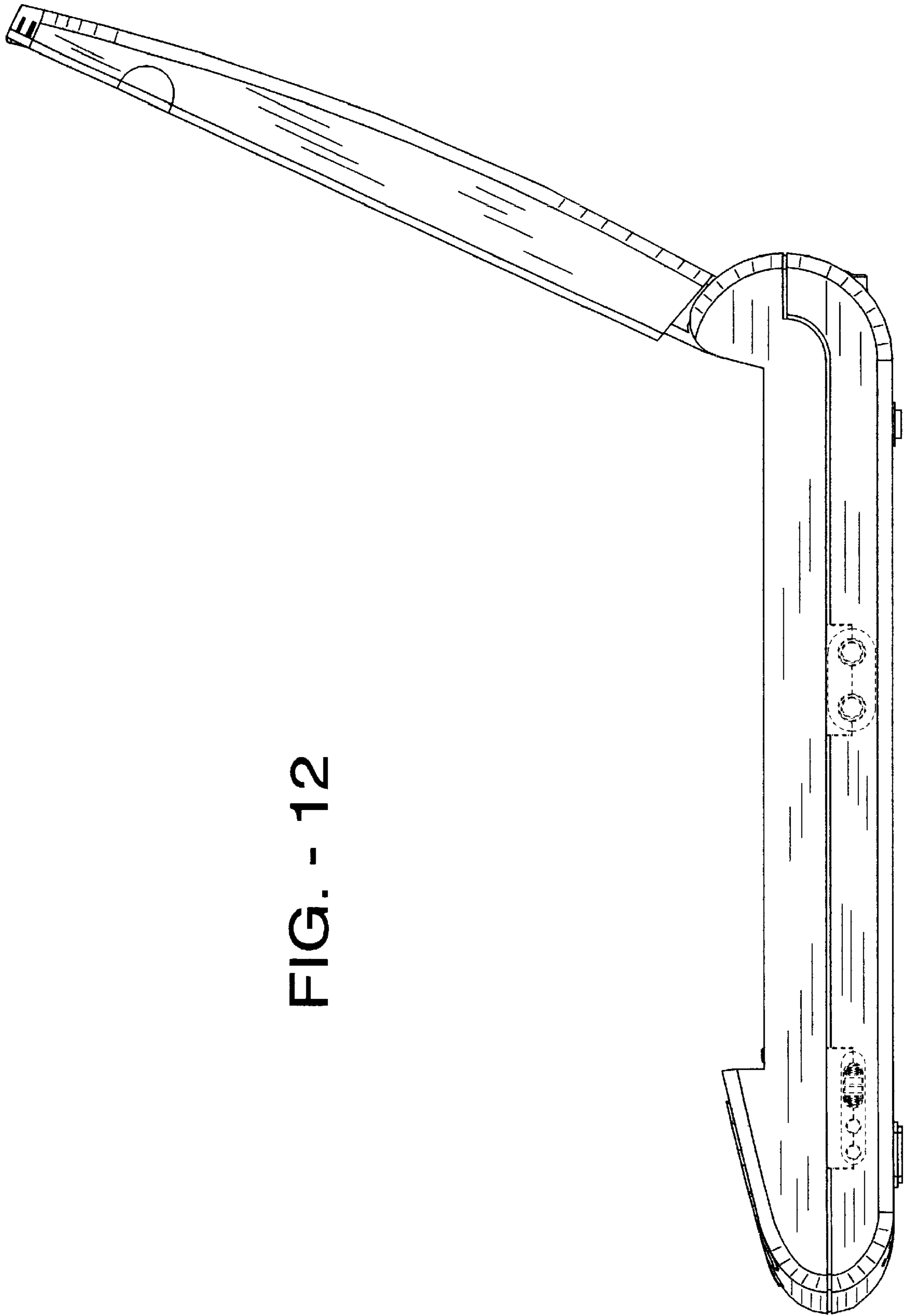

FIG. - 12