



US00D479163S

(12) **United States Design Patent**
Graves et al.

(10) **Patent No.:** **US D479,163 S**

(45) **Date of Patent:** **** Sep. 2, 2003**

(54) **SUSPENSION FORK FOR CYCLES**

(75) Inventors: **Brent T. Graves**, Woodland Hills;
James C. Rathbun, Burbank, both of
CA (US)

(73) Assignee: **Answer Products, Inc.**, Valencia, CA
(US)

(**) Term: **14 Years**

(21) Appl. No.: **29/130,628**

(22) Filed: **Oct. 6, 2000**

(51) **LOC (7) Cl.** **12-11**

(52) **U.S. Cl.** **D12/118**

(58) **Field of Search** D12/111, 118;
280/276-279, 281.1, 288.1-288.3

(56) **References Cited**

U.S. PATENT DOCUMENTS

D368,054 S 3/1996 Behrens
D411,147 S * 6/1999 Tsai D12/118

OTHER PUBLICATIONS

Bike Nashbar, Holiday 1998 catalog, suspension forks on p. 55.*

Performance ® Elite™ Early Summer 1998 catalog, suspension forks on p. W.*

Manitou 2000 Dealer Catalog, by Answer Products, Inc.

Mountain Biker, Apr. 2000—selected pages.

Mountain Biker, Jun. 2000—selected pages.

Mountain Biker, Oct. 2000—selected pages.

Pace The Portfolio, sales brochure by Pace Research, 1992.

Owners Manual Kevlar Suspension Fork, sales brochures by Pace Cycles Limited, Sep. 1993.

Pace Hardware Portfolio, sales brochure by Pace Cycles Limited, 1993.

Pace Owner's Manual RC-35 Monobox Suspension Fork Series, sales brochure by Pace Cycles Limited (undated) but believed to be prior to the Oct. 6, 2000, filing date of the instant application.

Jace Shnell "Deja Vu? The Reverse Brake Arch: Who Was First," *Mountain Biking*, May 2002, Cover and pp. 74-75.

* cited by examiner

Primary Examiner—Alan P. Douglas

Assistant Examiner—Linda Brooks

(74) *Attorney, Agent, or Firm*—Lawrence E. Laubscher, Sr.

(57) **CLAIM**

The ornamental design for a suspension fork for cycles, as shown.

DESCRIPTION

FIG. 1 is a front perspective view of a first embodiment of the suspension fork for cycles;

FIG. 2 is an enlarged front elevation view of FIG. 1;

FIG. 3 is an enlarged rear elevation view of FIG. 1;

FIG. 4 is an enlarged right side elevation view of FIG. 1;

FIG. 5 is an enlarged left side elevation view of FIG. 1;

FIG. 6 is an enlarged top plan view of FIG. 1;

FIG. 7 is an enlarged bottom plan view of FIG. 1;

FIG. 8 is a front perspective view of a second embodiment of the suspension fork for cycles;

FIG. 9 is an enlarged front elevation view of FIG. 8;

FIG. 10 is an enlarged rear elevation view of FIG. 8;

FIG. 11 is an enlarged right side elevation view of FIG. 8;

FIG. 12 is an enlarged left side elevation view of FIG. 8;

FIG. 13 is an enlarged top plan view of FIG. 8; and,

FIG. 14 is an enlarged bottom plan view of FIG. 8.

The broken lines form no part of this invention.

1 Claim, 6 Drawing Sheets

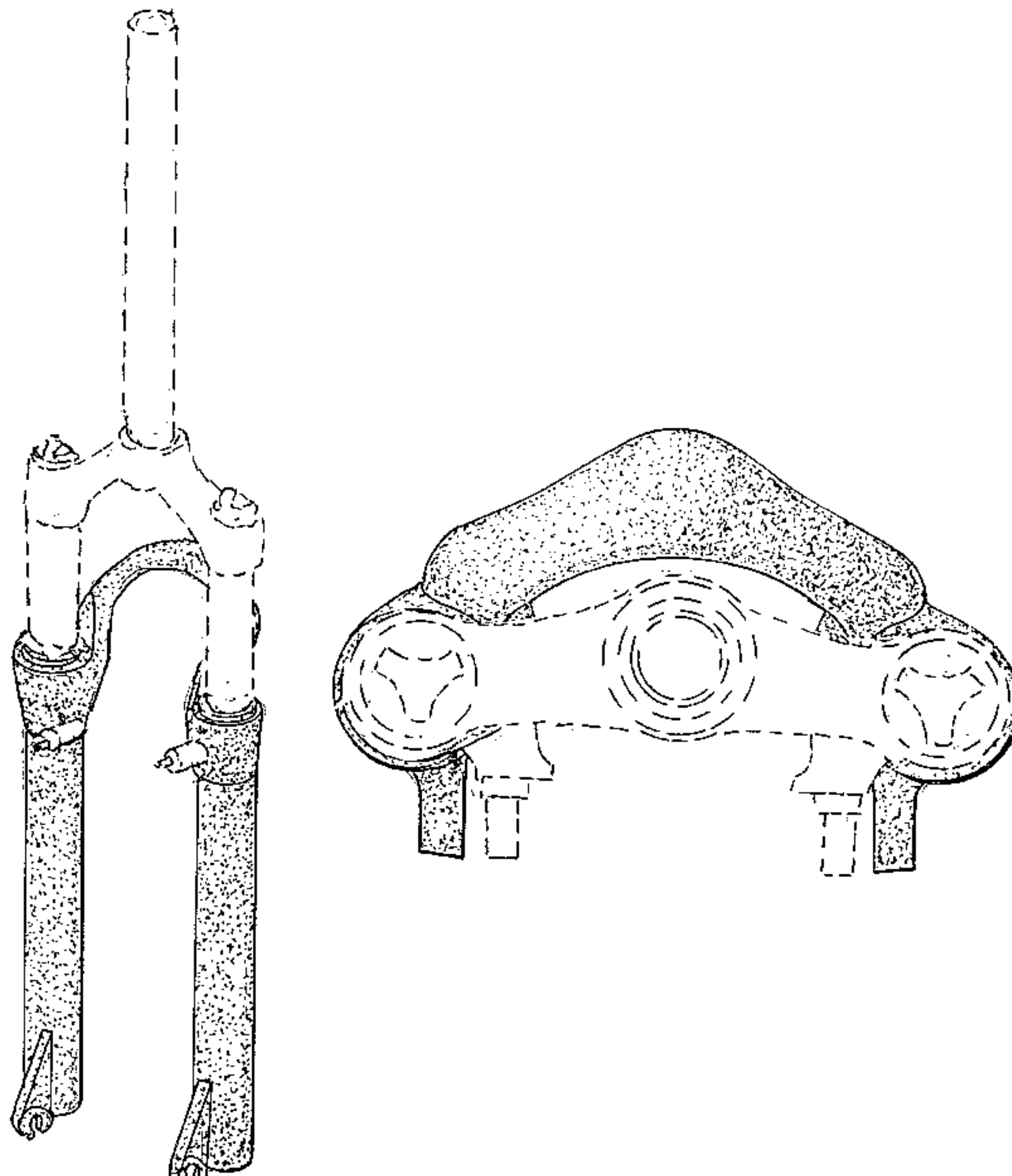

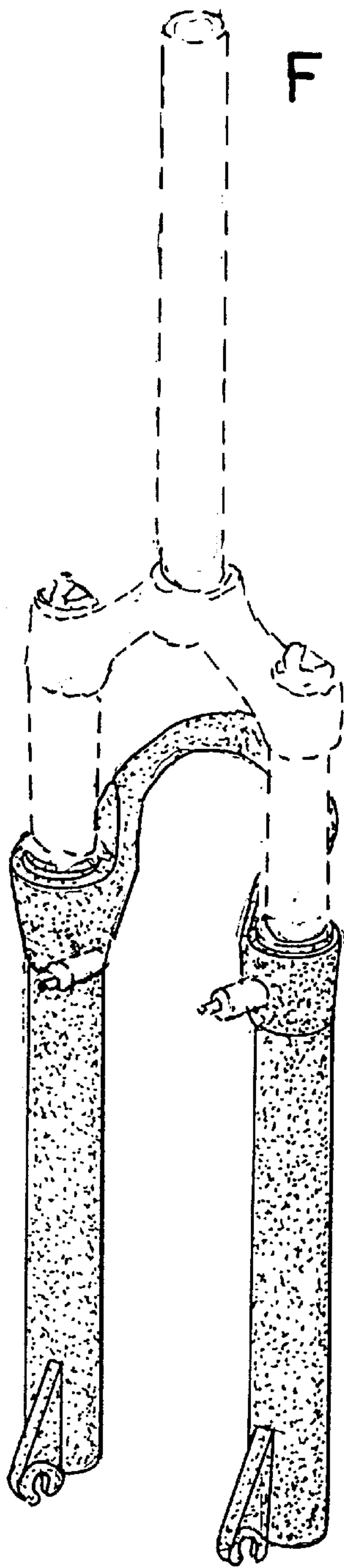

FIG. 1

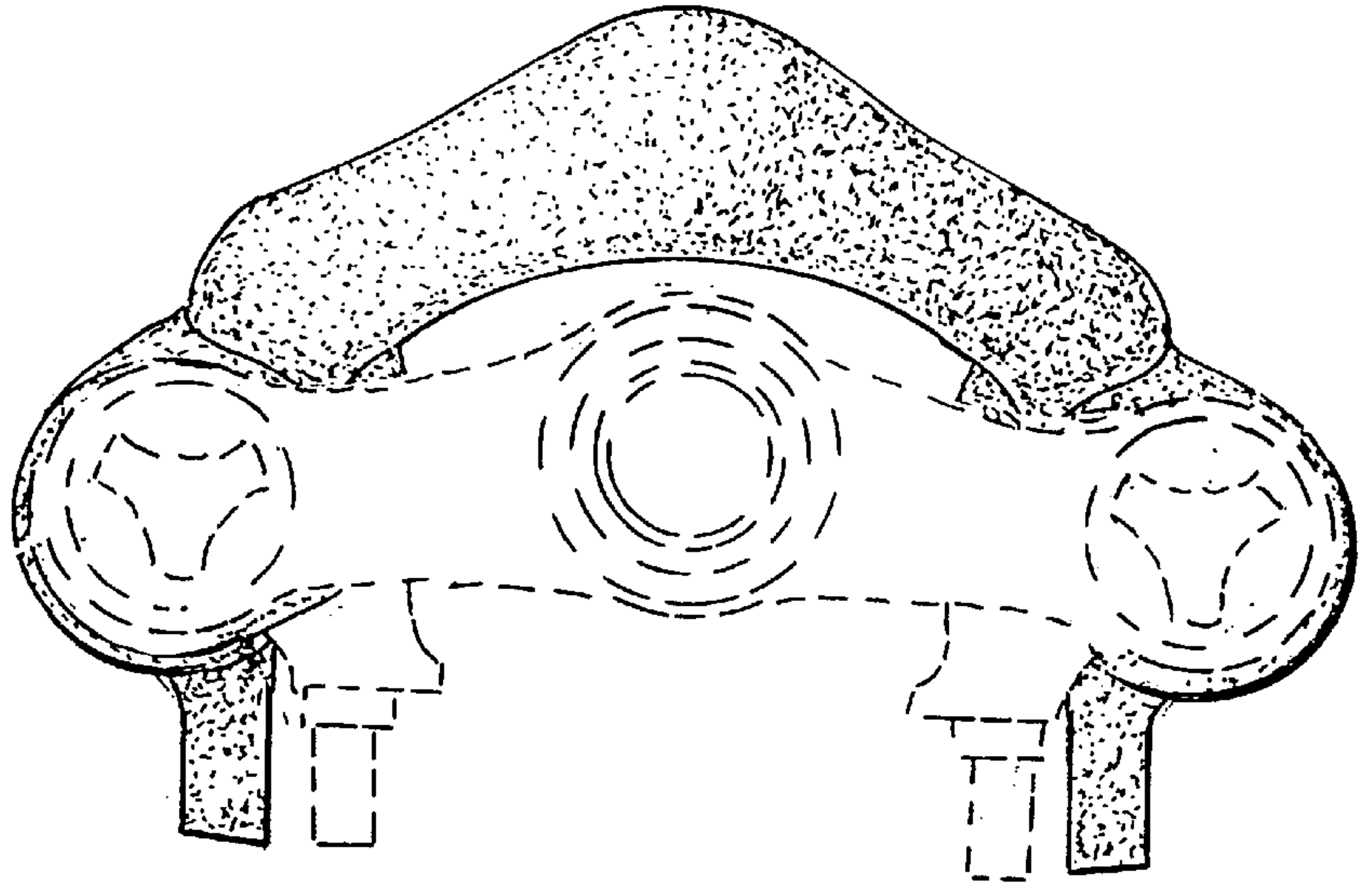

FIG. 6

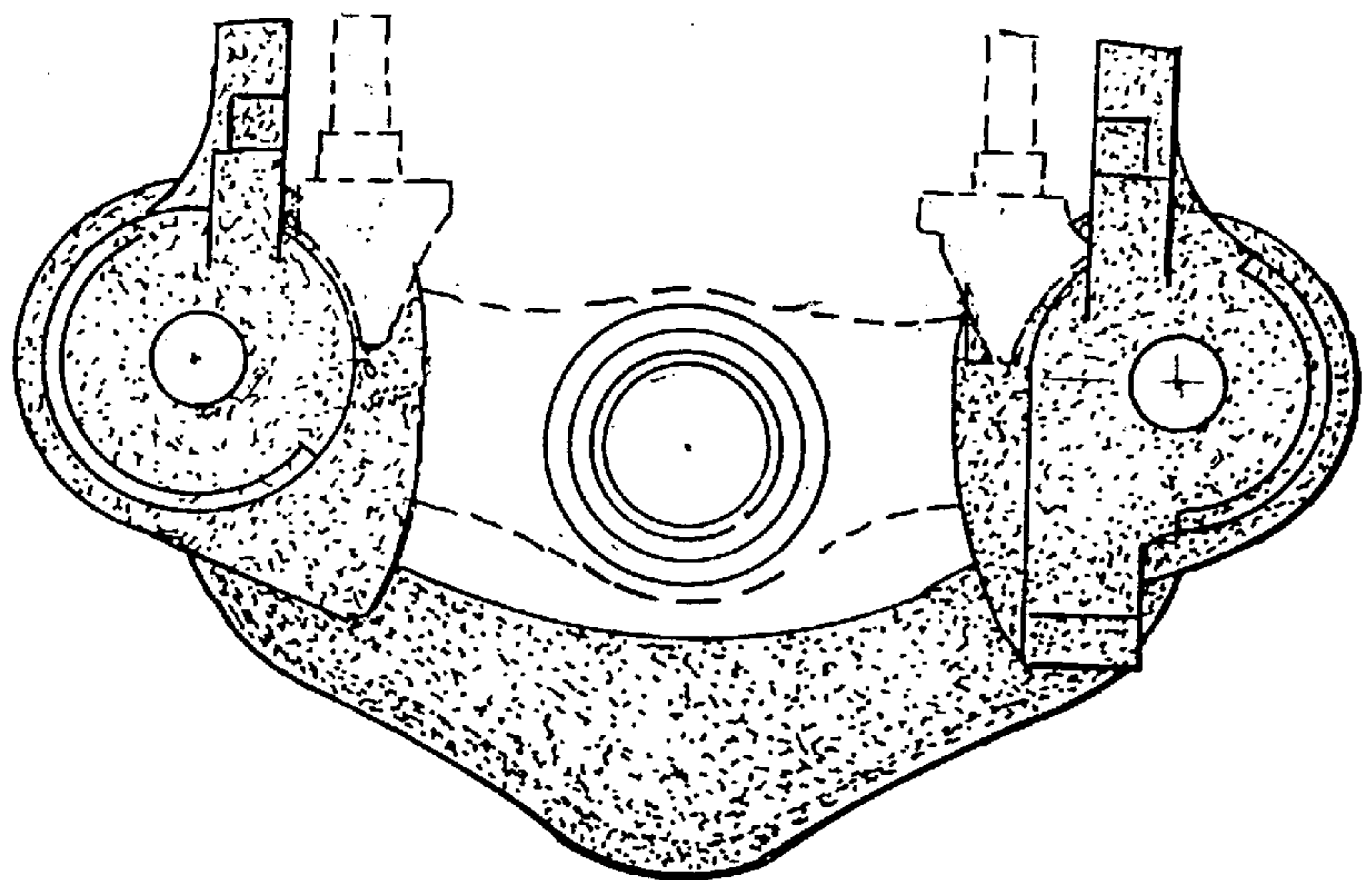

FIG. 7

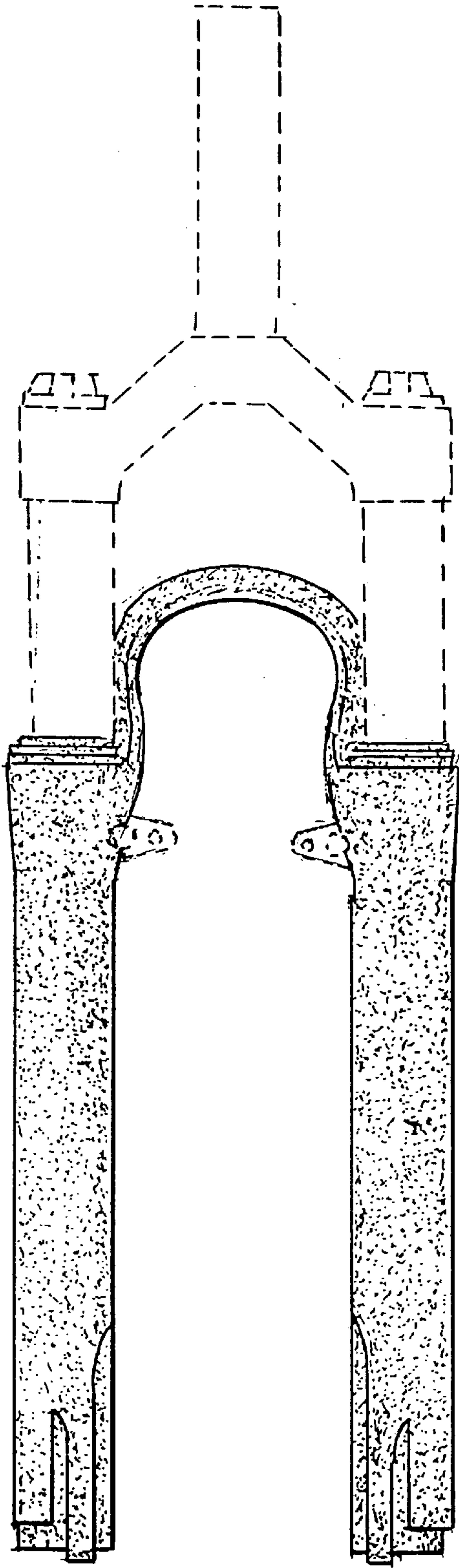

FIG. 2

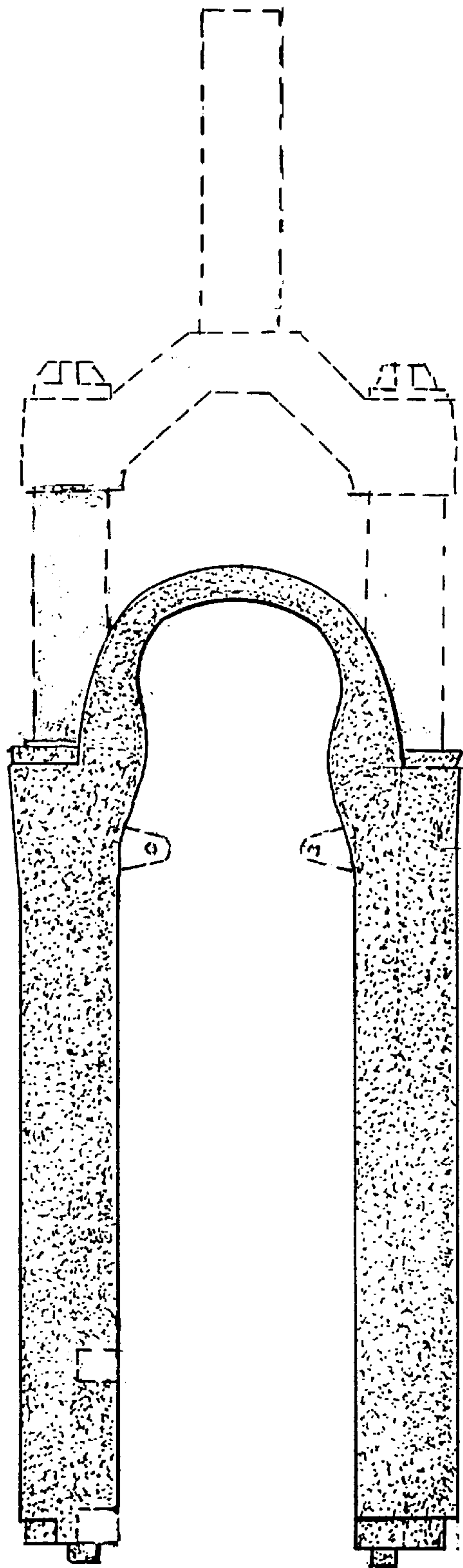

FIG. 3

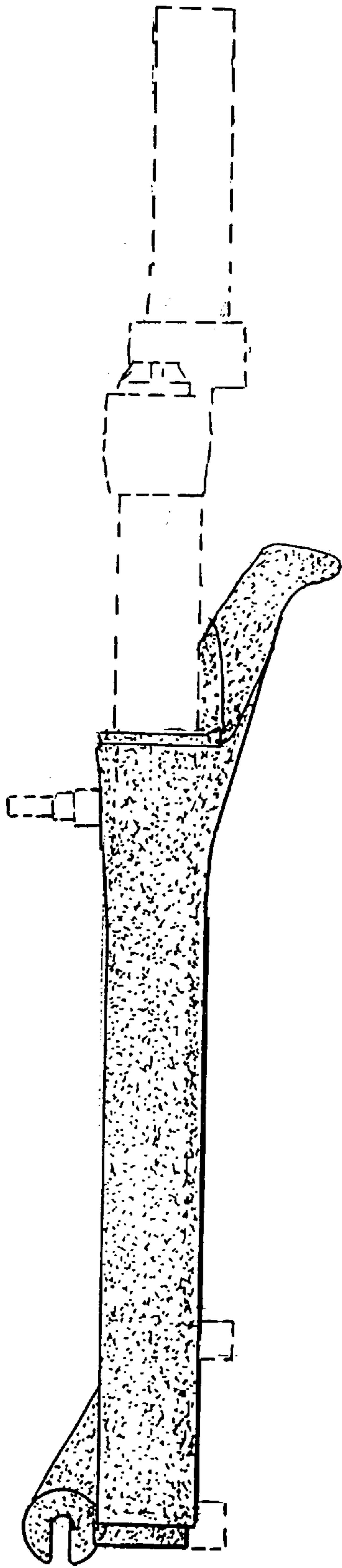

FIG. 4

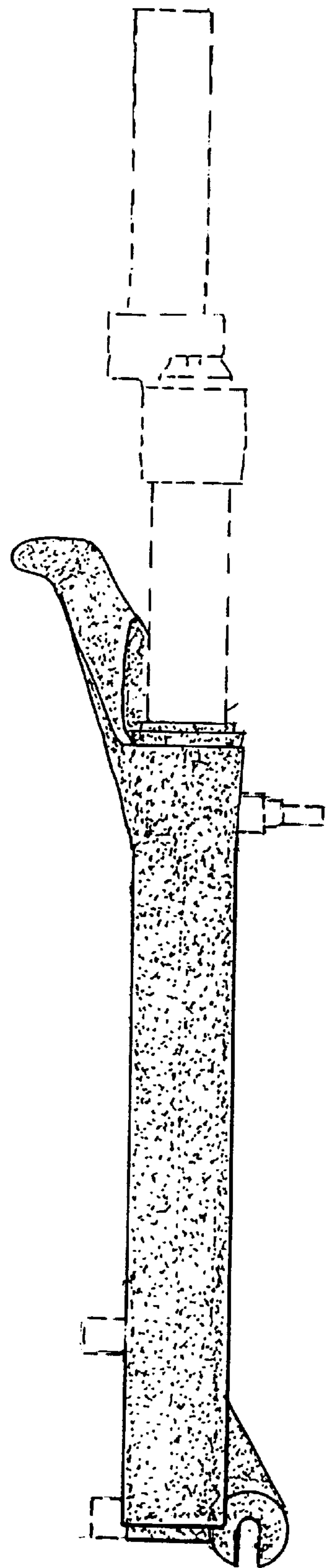

FIG. 5

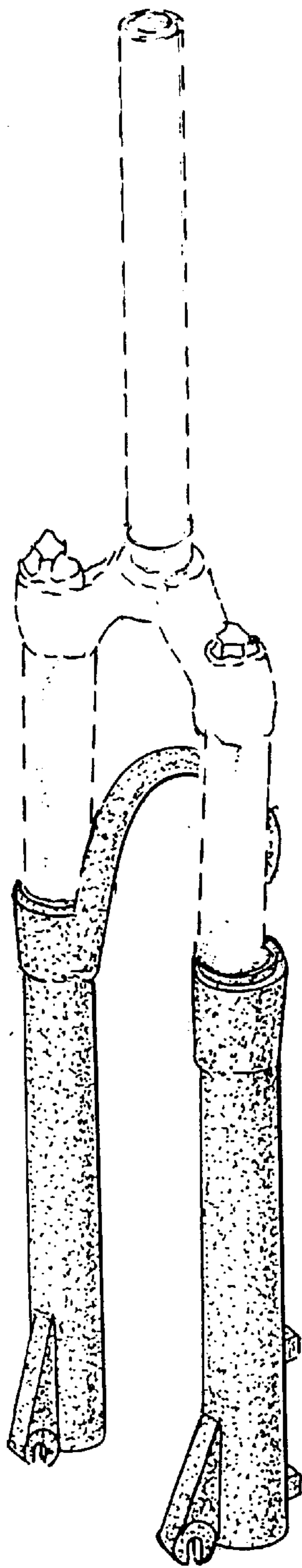
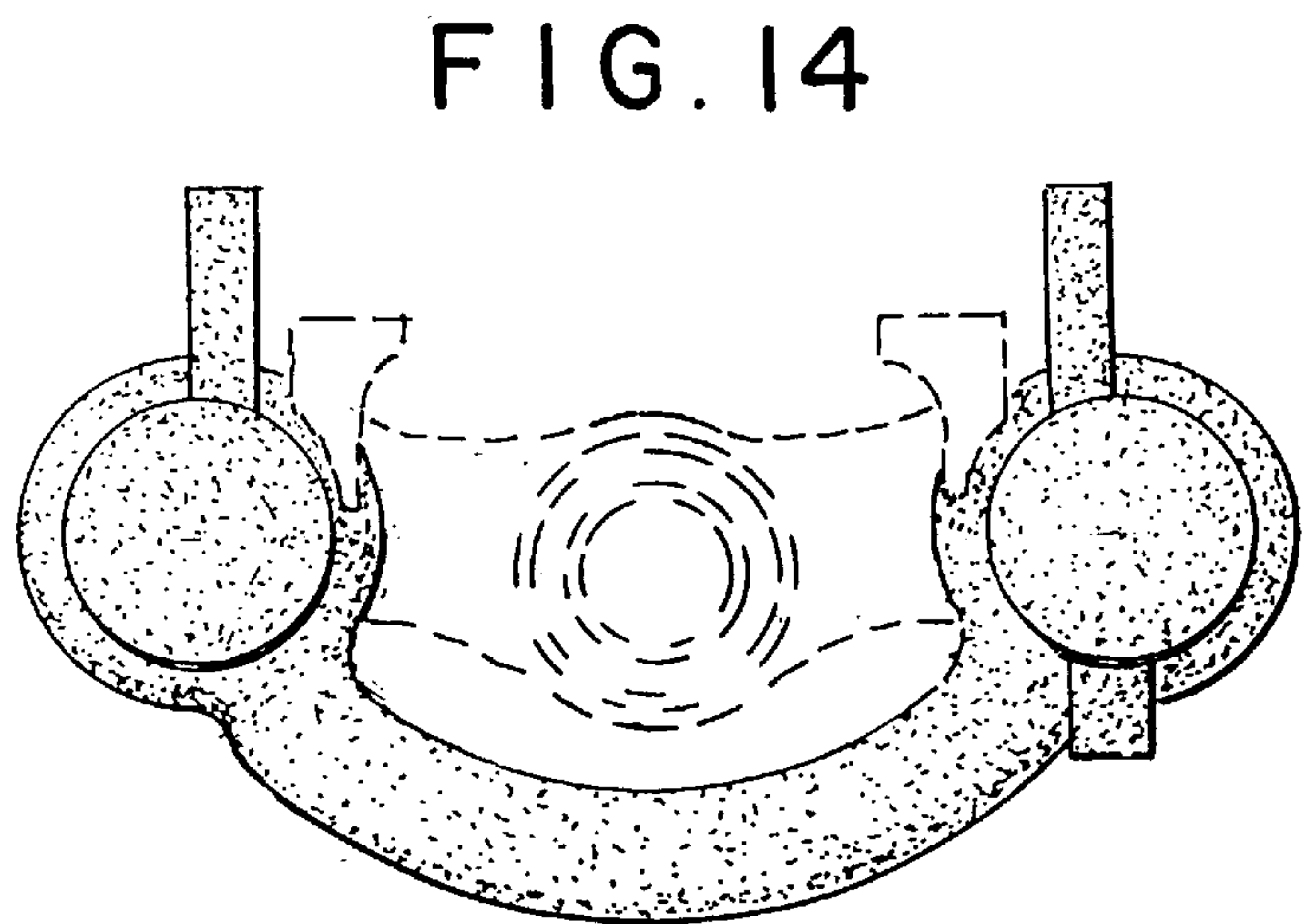
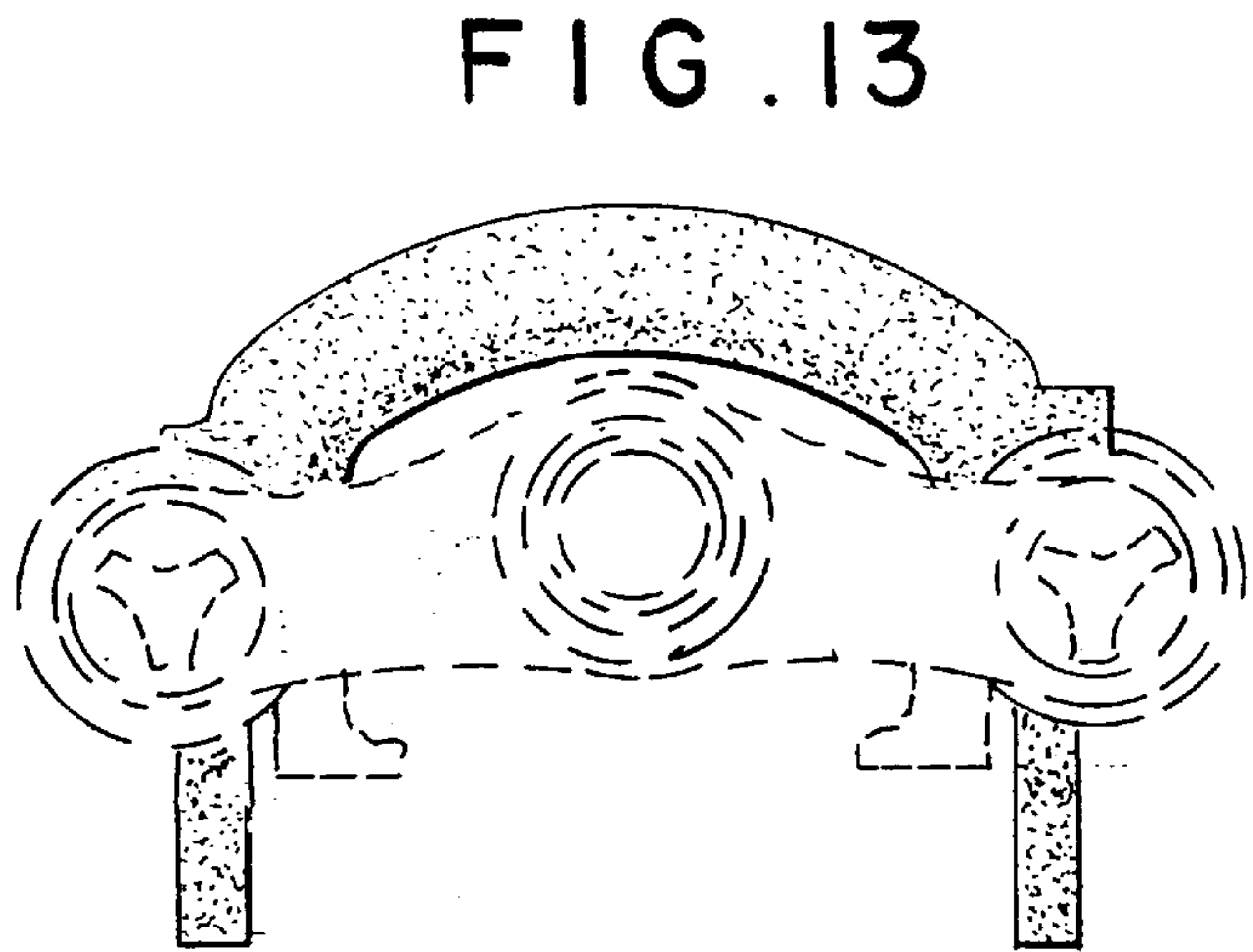

FIG. 8



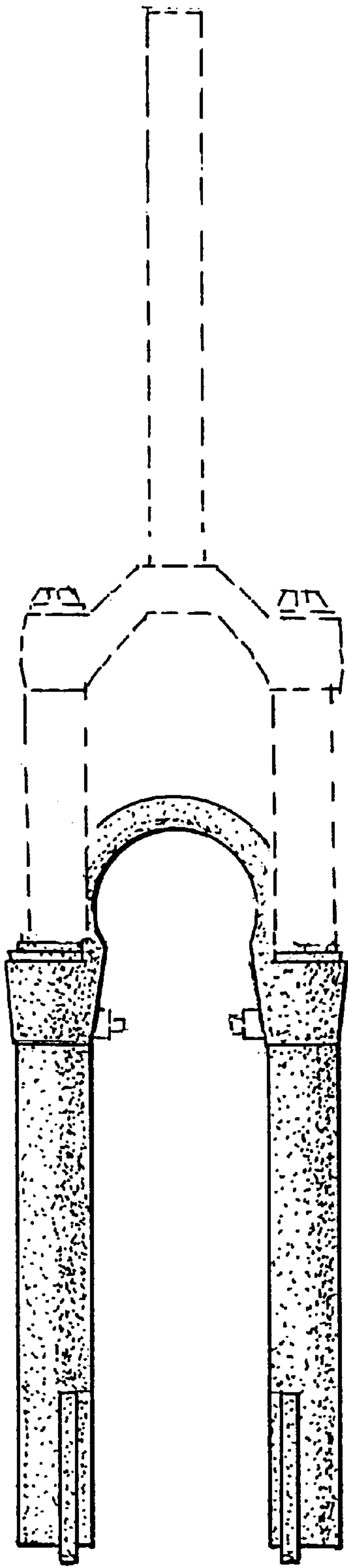

FIG. 9

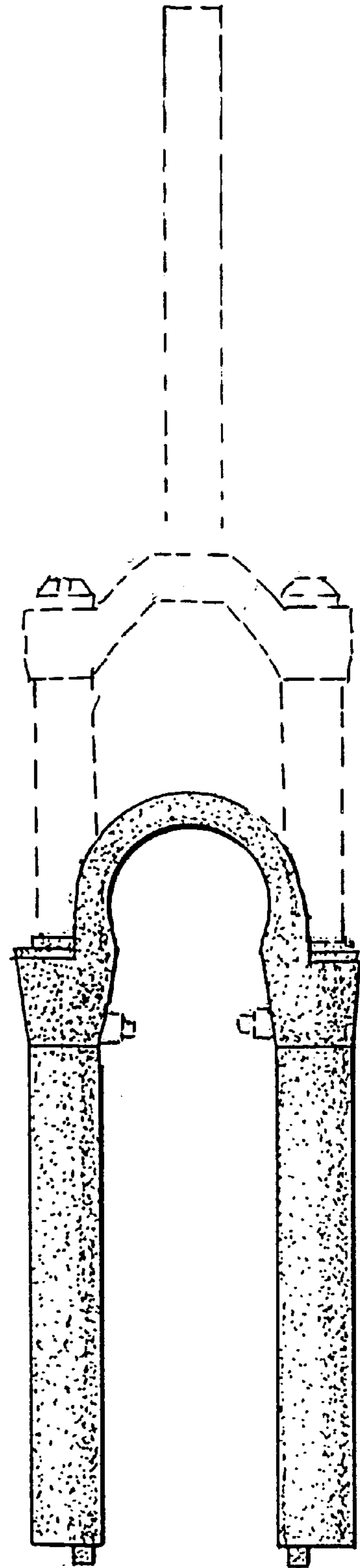

FIG. 10

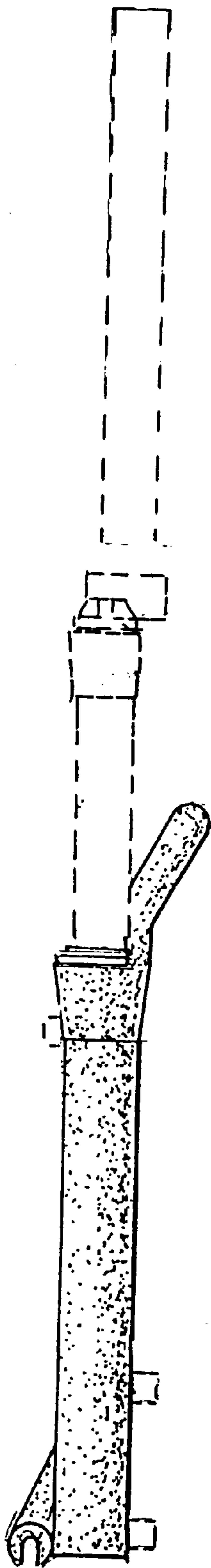

FIG. 11

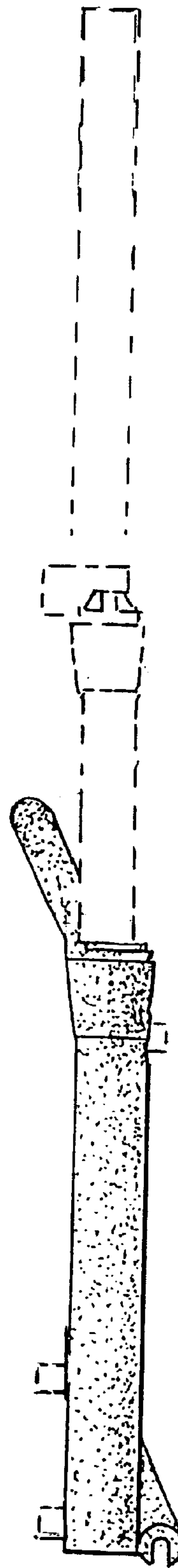

FIG. 12