



US00D479151S

(12) **United States Design Patent**
Hamilton

(10) **Patent No.:** **US D479,151 S**

(45) **Date of Patent:** **** Sep. 2, 2003**

(54) **STERNUM BUCKLE AND SLIDER SET**

(75) **Inventor:** **Jeffrey R. Hamilton**, Hoffman Estates, IL (US)

(73) **Assignee:** **Illinois Tool Works Inc.**, Glenview, IL (US)

(**) **Term:** **14 Years**

(21) **Appl. No.:** **29/153,078**

(22) **Filed:** **Jan. 4, 2002**

(51) **LOC (7) Cl.** **02-07**

(52) **U.S. Cl.** **D11/216**

(58) **Field of Search** D11/200, 201, D11/210, 212-214, 216, 218, 231, 234, 236, 86-87; 24/196, 316, 326, 616, 644, 615, 575

(56) **References Cited**

U.S. PATENT DOCUMENTS

- D348,236 S * 6/1994 James D11/216
- D447,088 S * 8/2001 Anscher D11/216
- D447,979 S * 9/2001 Anscher D11/216

* cited by examiner

Primary Examiner—Ralf Seifert

(74) *Attorney, Agent, or Firm*—Mark W. Croll; Paul F. Donovan

(57) **CLAIM**

The ornamental design for a sternum buckle and slider set, as shown and described herein.

DESCRIPTION

FIG. 1 is a perspective view of a sternum buckle showing one aspect of the new design;

FIG. 2 is a top plan view thereof;

FIG. 3 is a side elevational view thereof;

FIG. 4 is a perspective view of a sternum slider showing another aspect of the new design;

FIG. 5 is a top plan view thereof;

FIG. 6 is a side elevational view thereof; and,

FIG. 7 is a showing of my claimed design in a position of use.

The bottom surface of both the sternum buckle and the sternum slider is not part of the design sought to be patented and is therefore not shown.

It being understood that the broken lines are for illustrative purposes only.

1 Claim, 3 Drawing Sheets

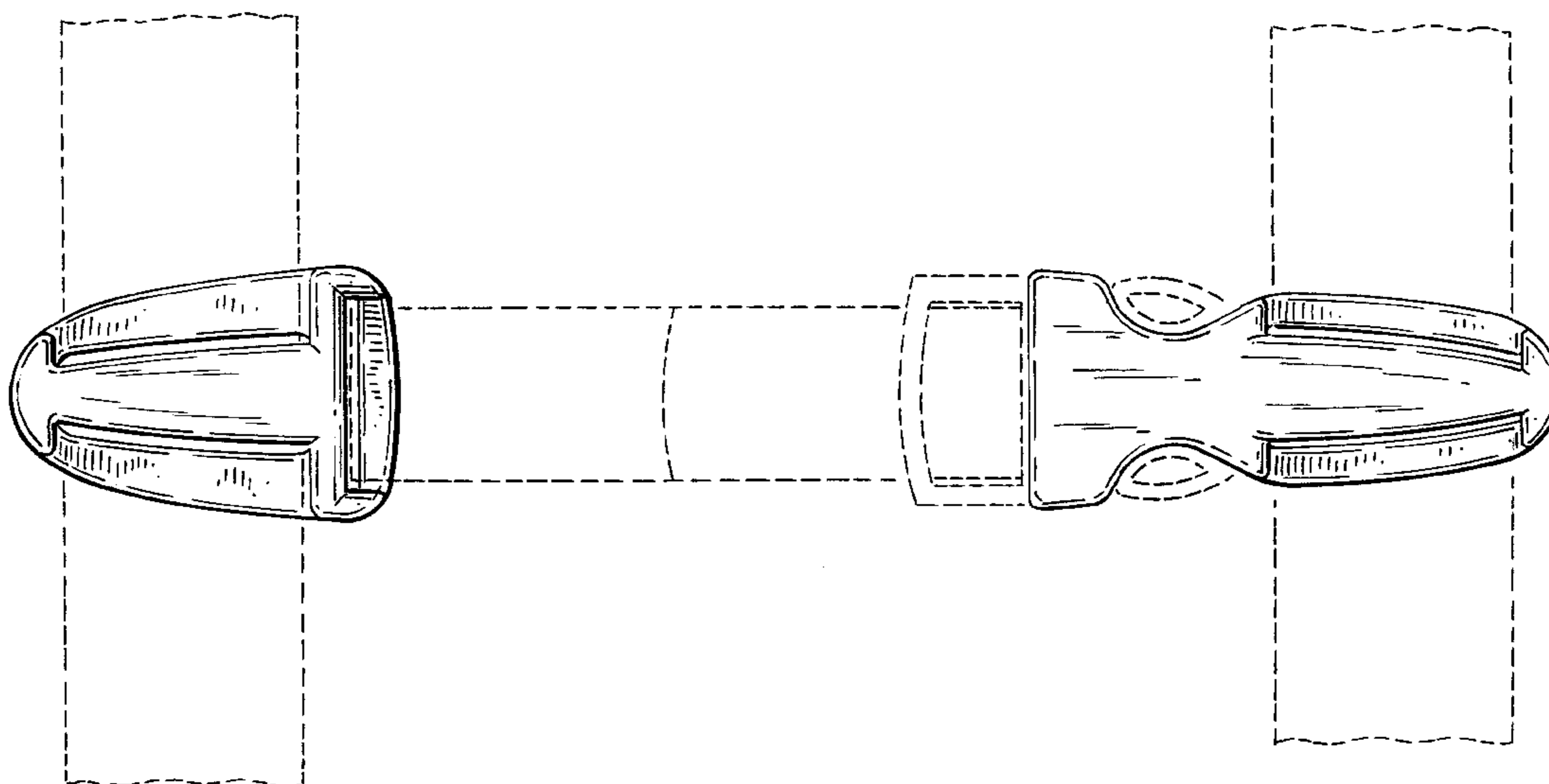

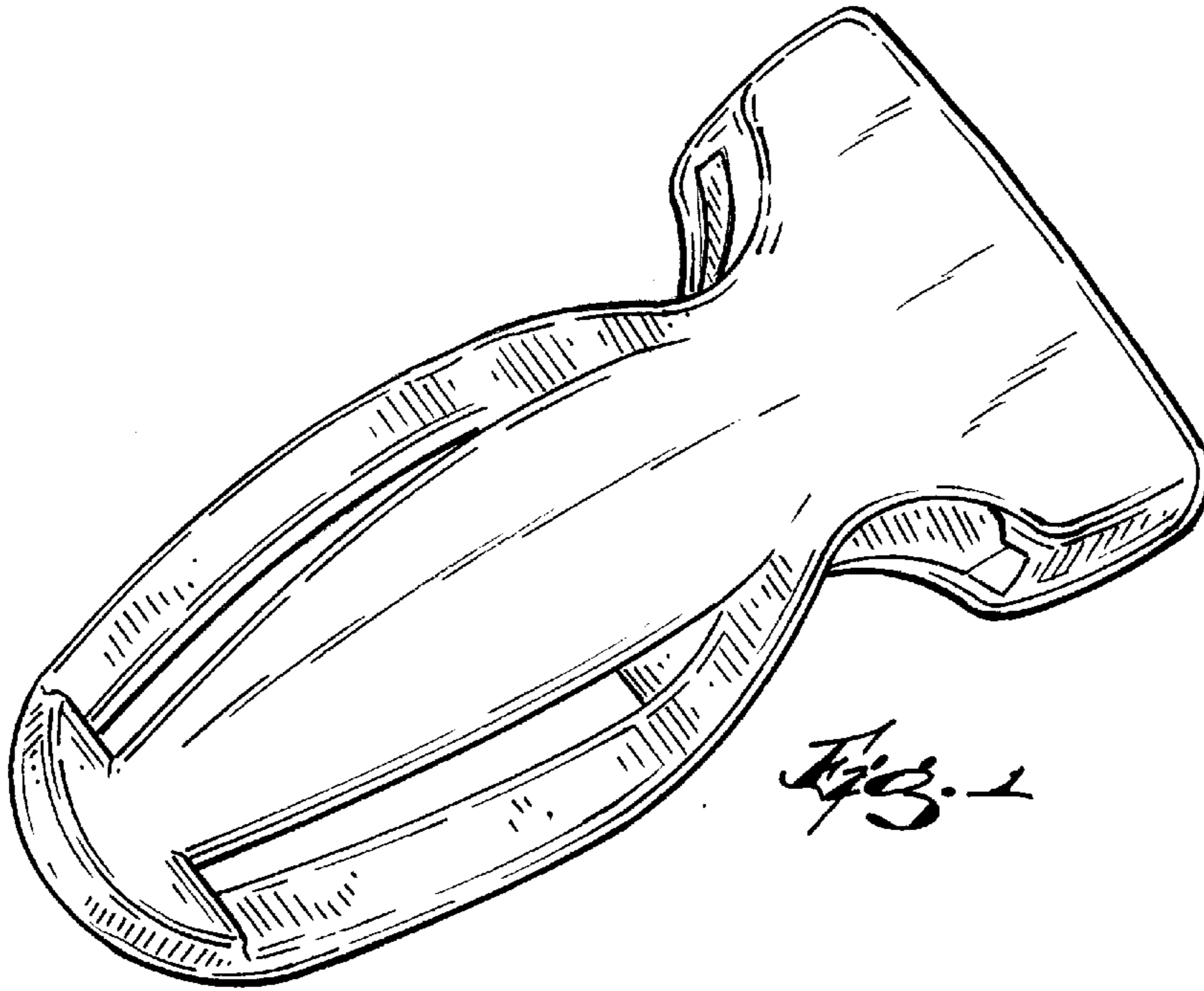

Fig. 1

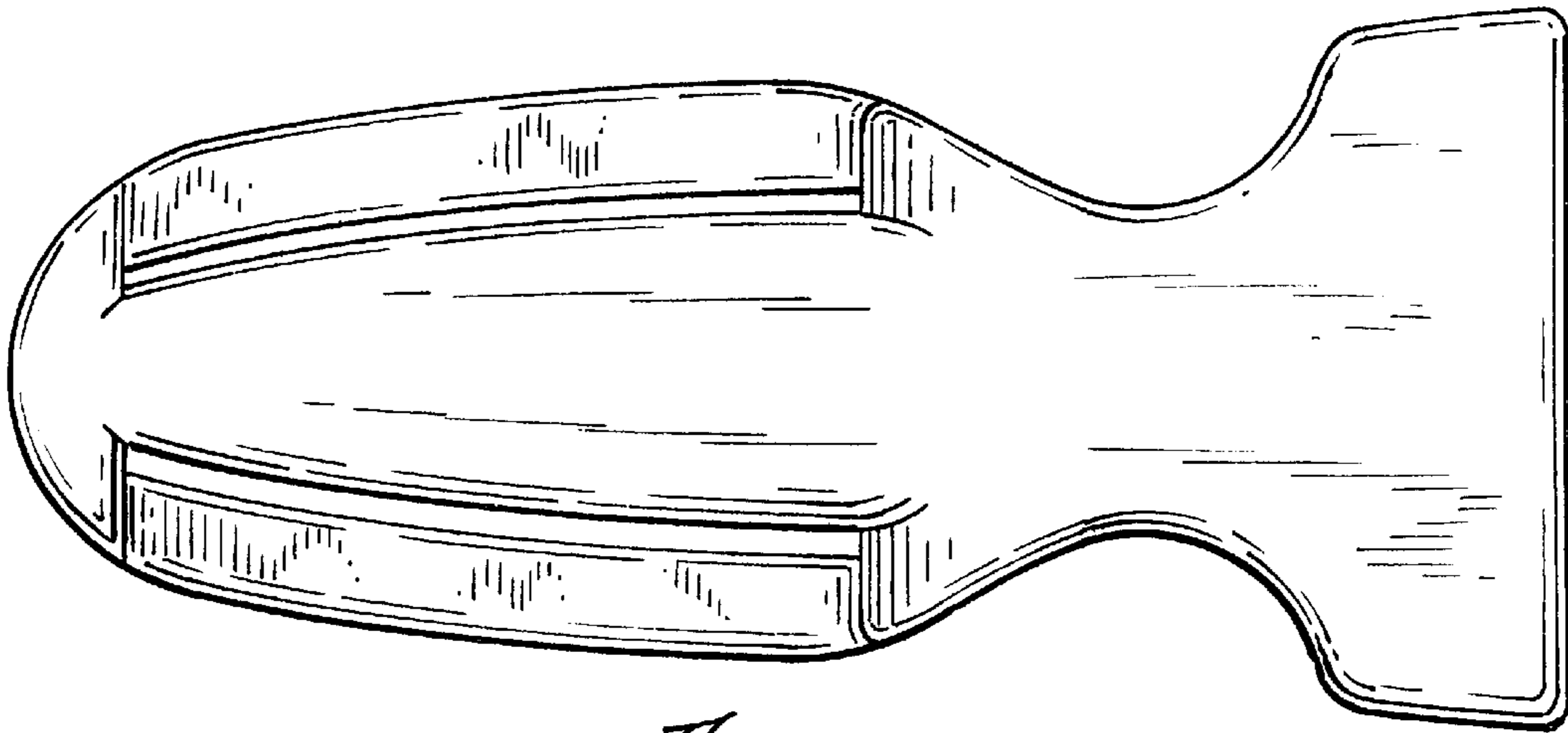

Fig. 2

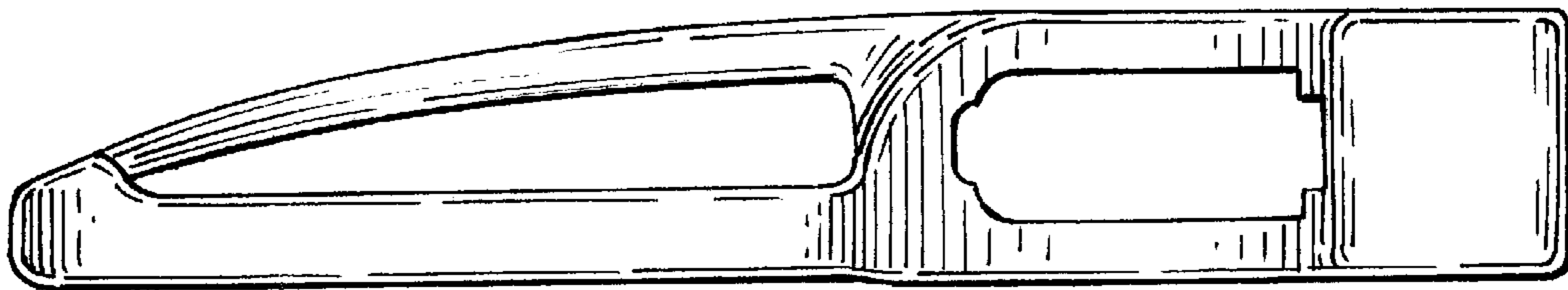

Fig. 3

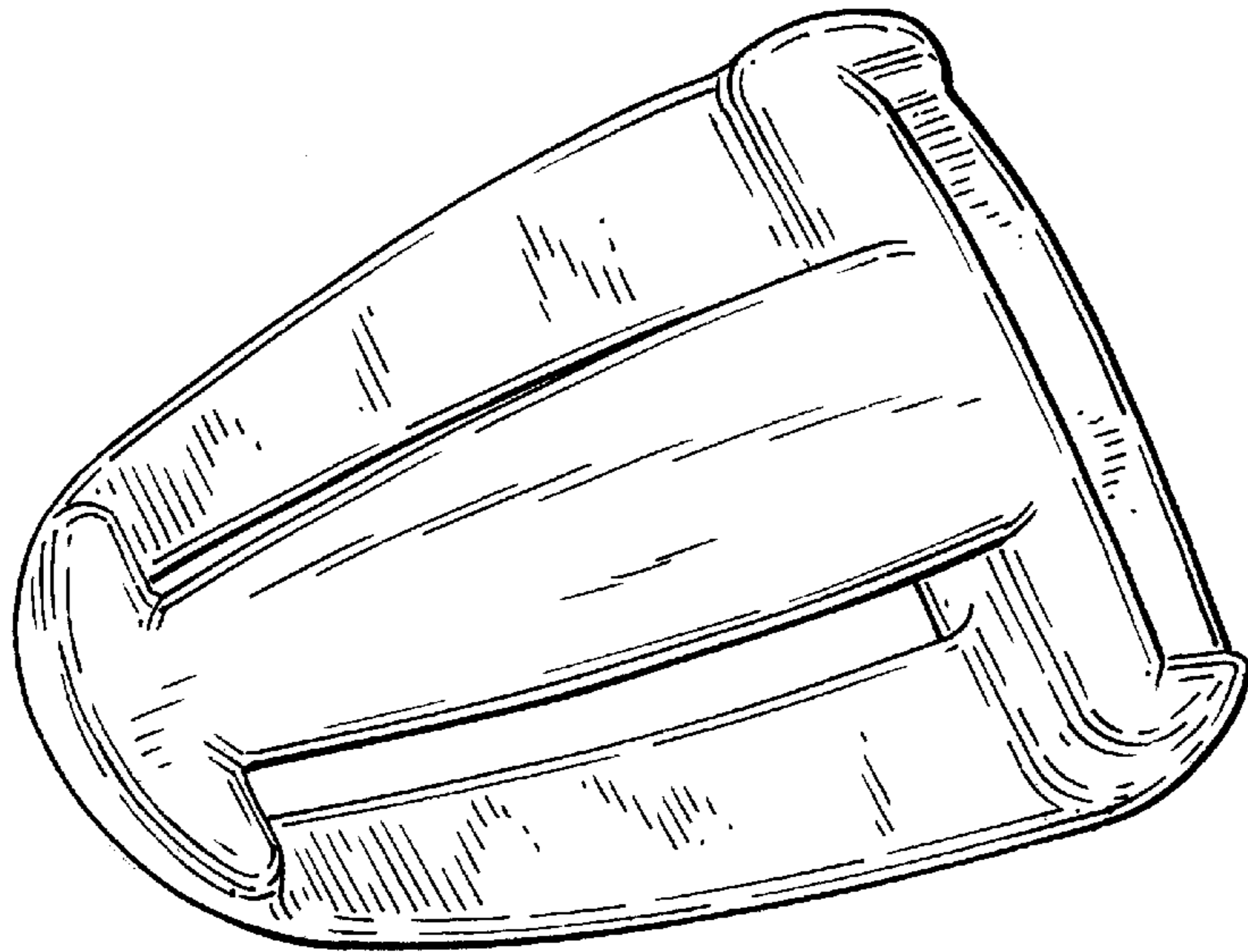

Fig. 4

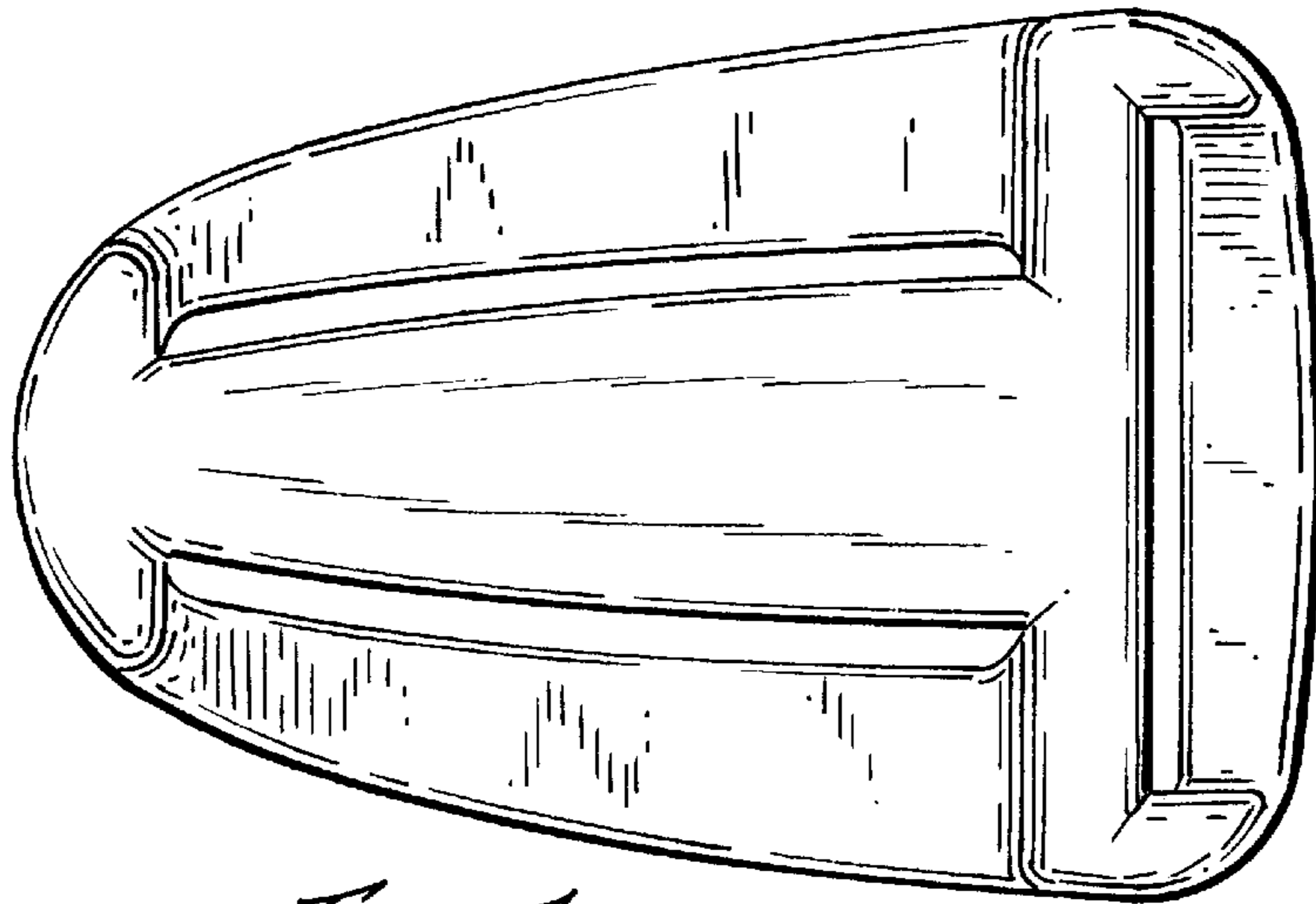

Fig. 5

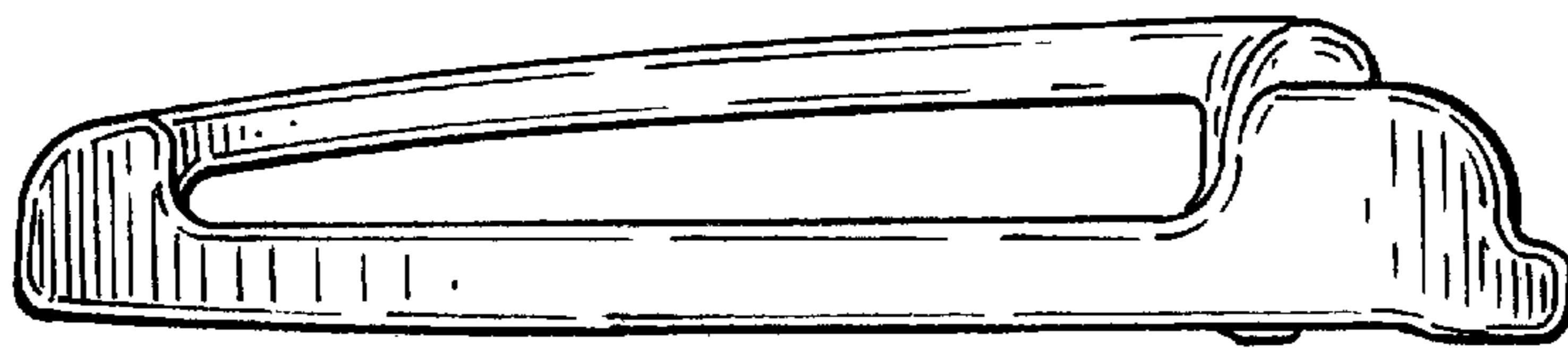

Fig. 6

