



US00D479145S

(12) **United States Design Patent**  
**Newman**

(10) **Patent No.:** **US D479,145 S**

(45) **Date of Patent:** **\*\* Sep. 2, 2003**

(54) **EARRING**

(76) **Inventor:** **Glenda J Newman**, 8015 Mc Glothin St., Jacksonville, FL (US) 32210

(\*\*) **Term:** **14 Years**

(21) **Appl. No.:** **29/148,853**

(22) **Filed:** **Sep. 28, 2001**

(51) **LOC (7) Cl.** ..... **11-01**

(52) **U.S. Cl.** ..... **D11/40**

(58) **Field of Search** ..... D11/40-49, 51-53,  
D11/55-56, 60, 63-70, 75-78; 63/3, 14.1,  
12-13, 20, 26-28, 32

(56) **References Cited**

**U.S. PATENT DOCUMENTS**

389,830	A	*	9/1888	Ballou	.....	63/13
421,099	A	*	2/1890	Kelley	.....	63/14.2
D151,422	S	*	10/1948	Wapnick	.....	D11/53
D156,220	S	*	11/1949	DiCicco	.....	D11/43
2,502,386	A	*	3/1950	Mailand	.....	63/14.2
D160,246	S	*	9/1950	Brandano	.....	D11/40
D169,726	S	*	6/1953	Bell	.....	D11/40
D169,727	S	*	6/1953	Bell	.....	D11/77
D170,442	S	*	9/1953	Bell	.....	D11/40
D176,295	S	*	12/1955	Weissman	.....	D11/40

3,898,868	A	*	8/1975	Tomlinson	.....	63/1.16
D264,060	S	*	4/1982	Epstein	.....	D11/40
5,074,128	A	*	12/1991	Kowalski	.....	63/12
D340,527	S	*	10/1993	Goodell	.....	D24/211
5,533,363	A	*	7/1996	Callisto	.....	63/14.1
5,964,105	A	*	10/1999	Nakamura	.....	63/14.1

\* cited by examiner

*Primary Examiner*—Cathy Anne MacCormac

(57) **CLAIM**

The ornamental design for an earring, as shown and described.

**DESCRIPTION**

FIG. 1 is a front elevational view of the earring of the present invention;  
 FIG. 2 is a rear elevational view thereof;  
 FIG. 3 is a left side elevational view of thereof;  
 FIG. 4 is a right side elevational view thereof;  
 FIG. 5 is a top plan view thereof;  
 FIG. 6 is a bottom plan view thereof; and,  
 FIG. 7 is another left side elevational view thereof showing the jewel setting in an alternate position.  
 The broken lines of the jewels in FIGS. 1-7 are for illustrative purposes only and form no part of the claimed design.

**1 Claim, 4 Drawing Sheets**

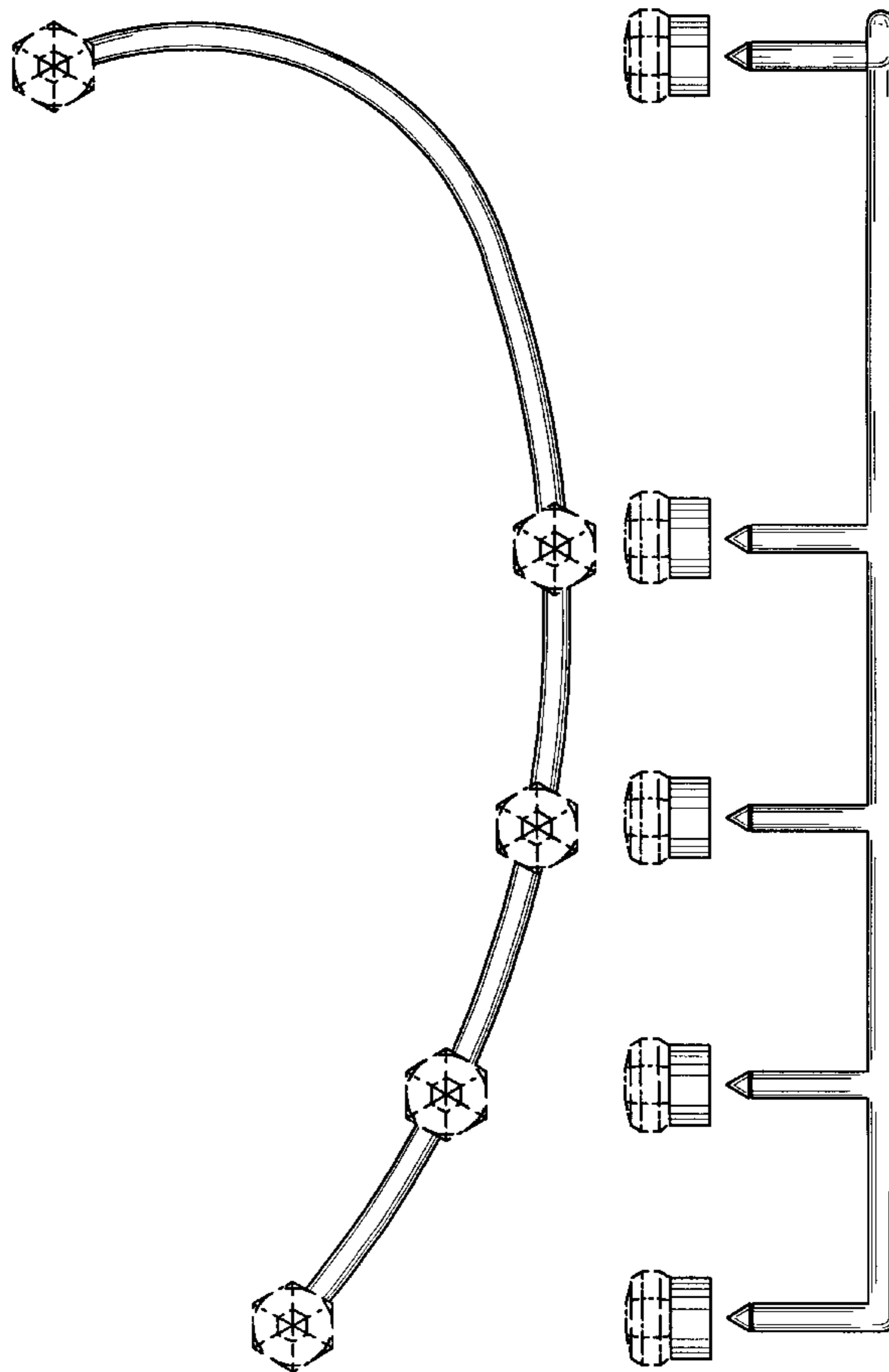

FIG. 2

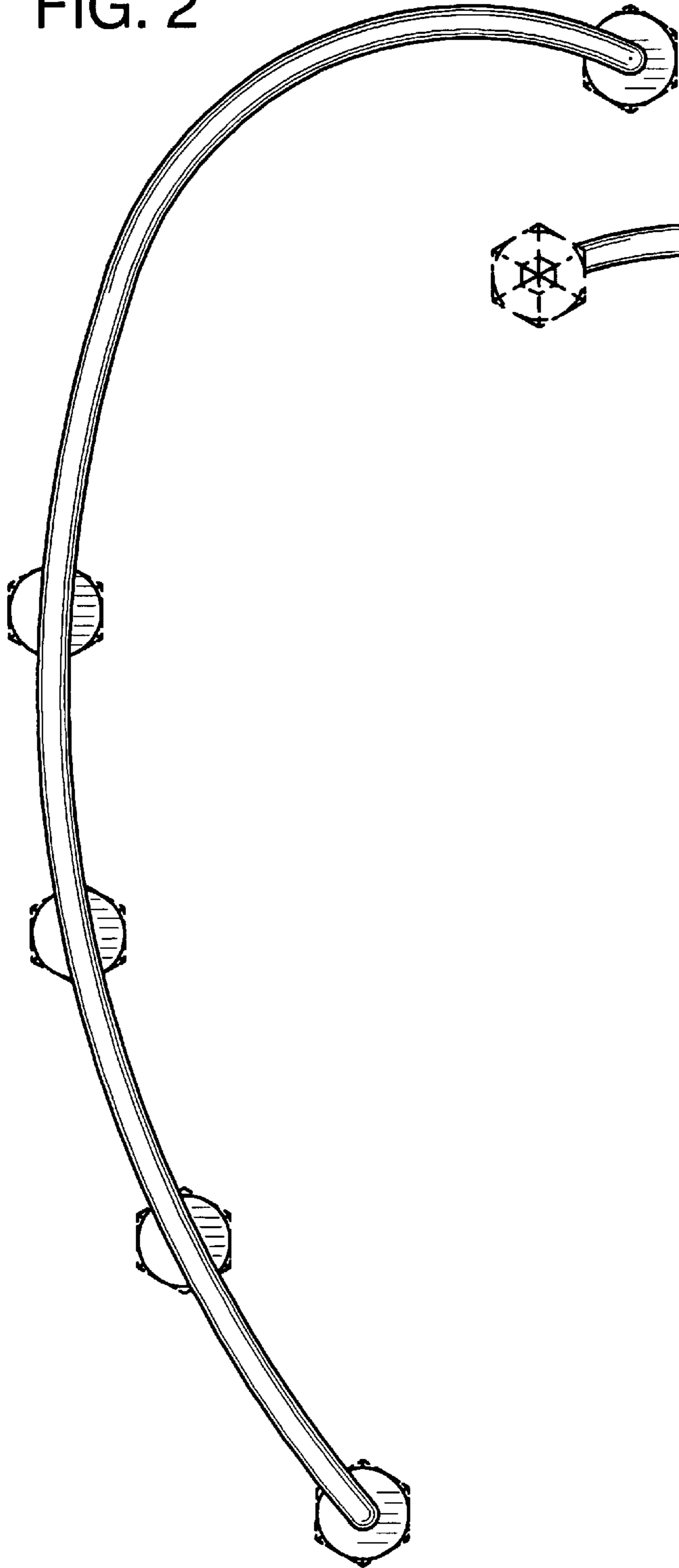
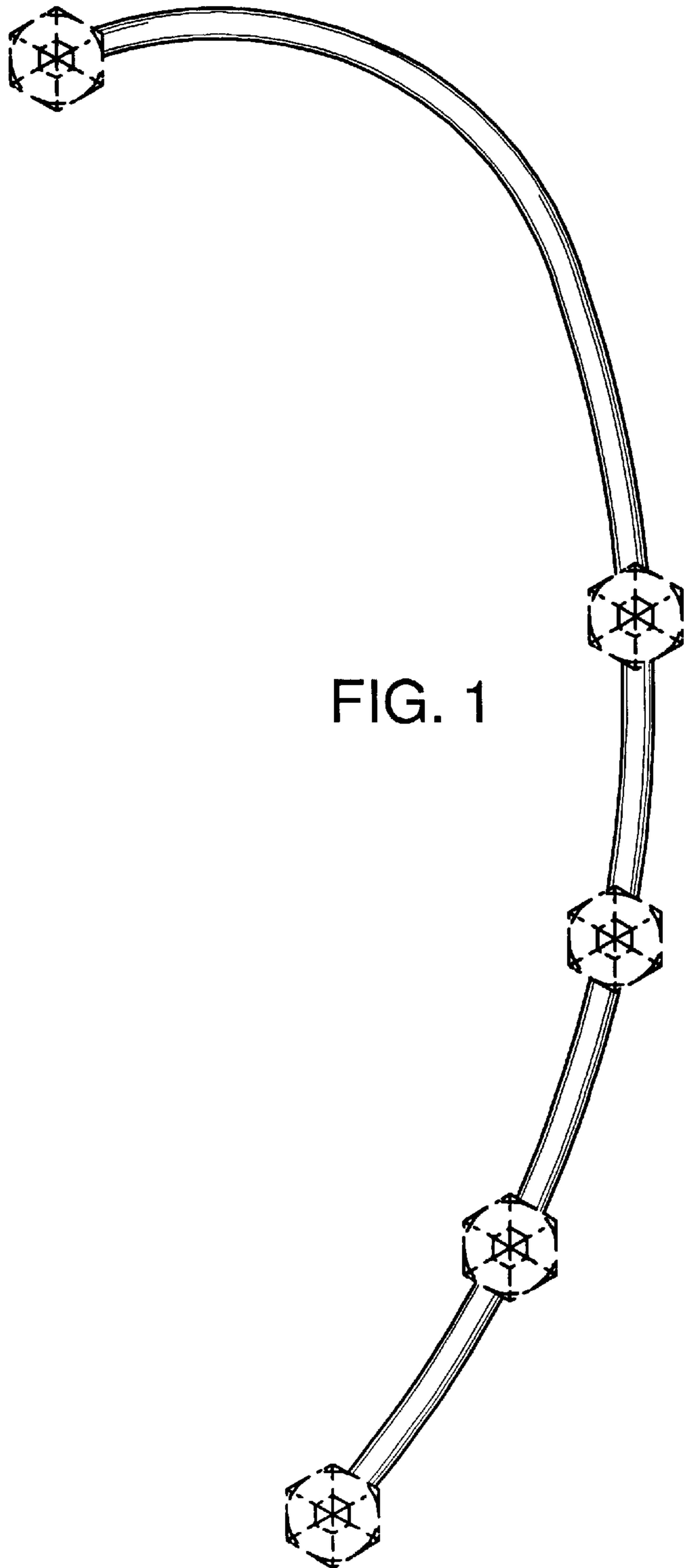

FIG. 1



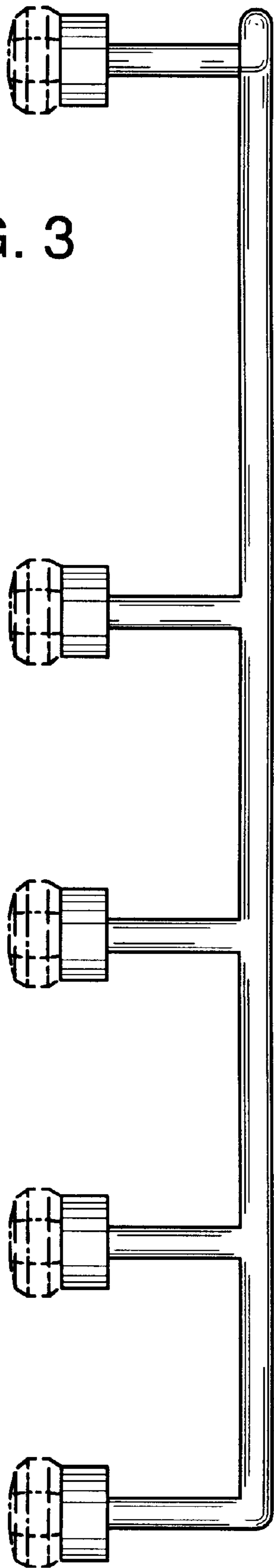

FIG. 3

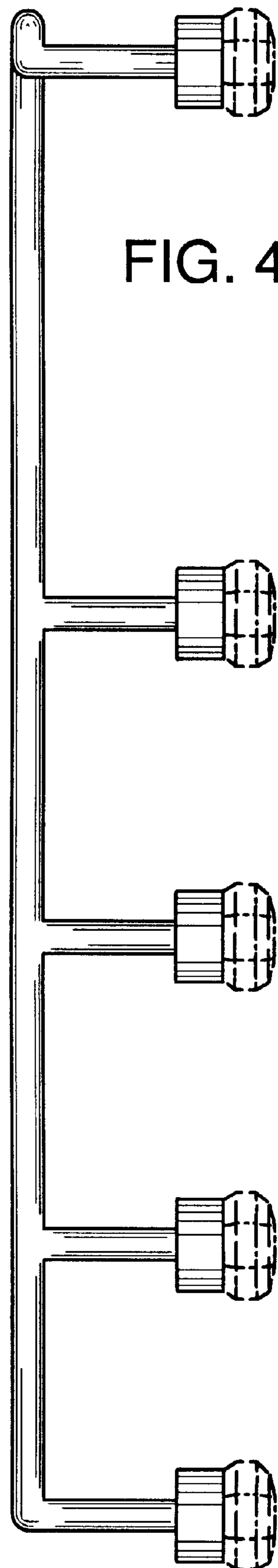

FIG. 4

FIG. 5

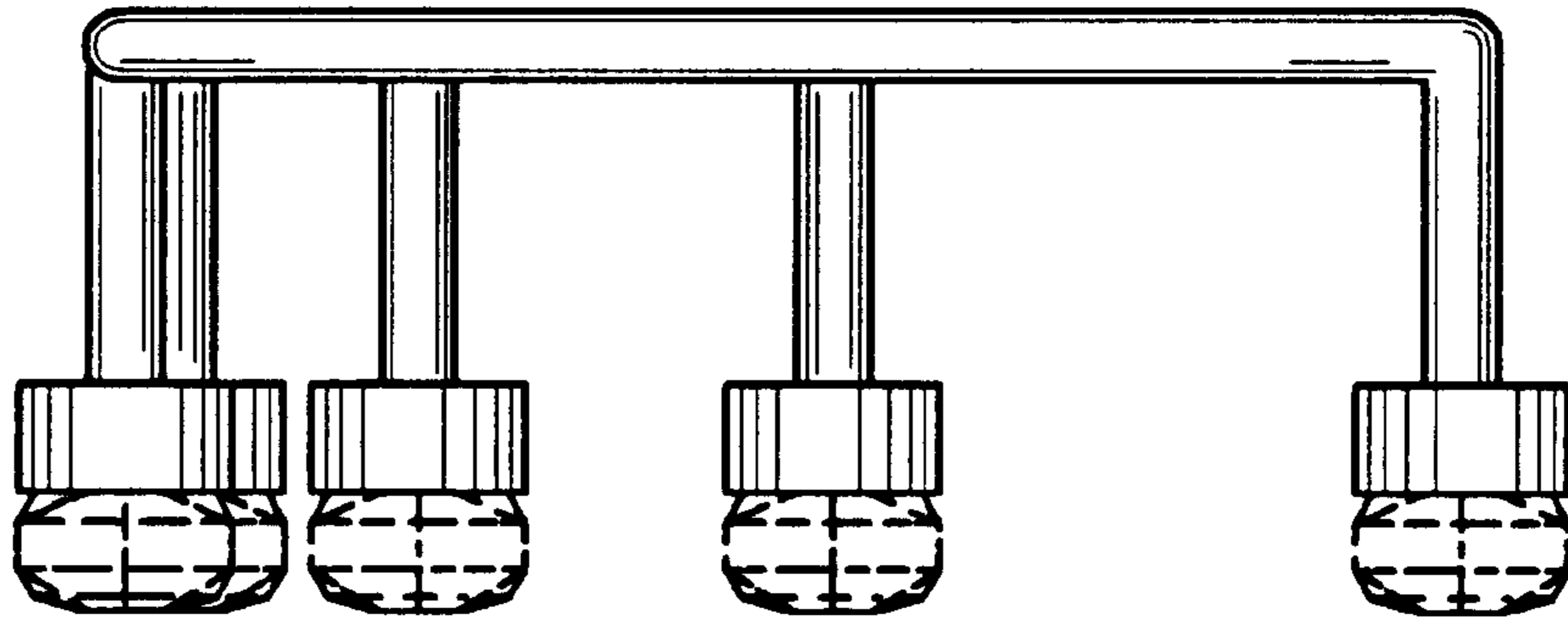

FIG. 6

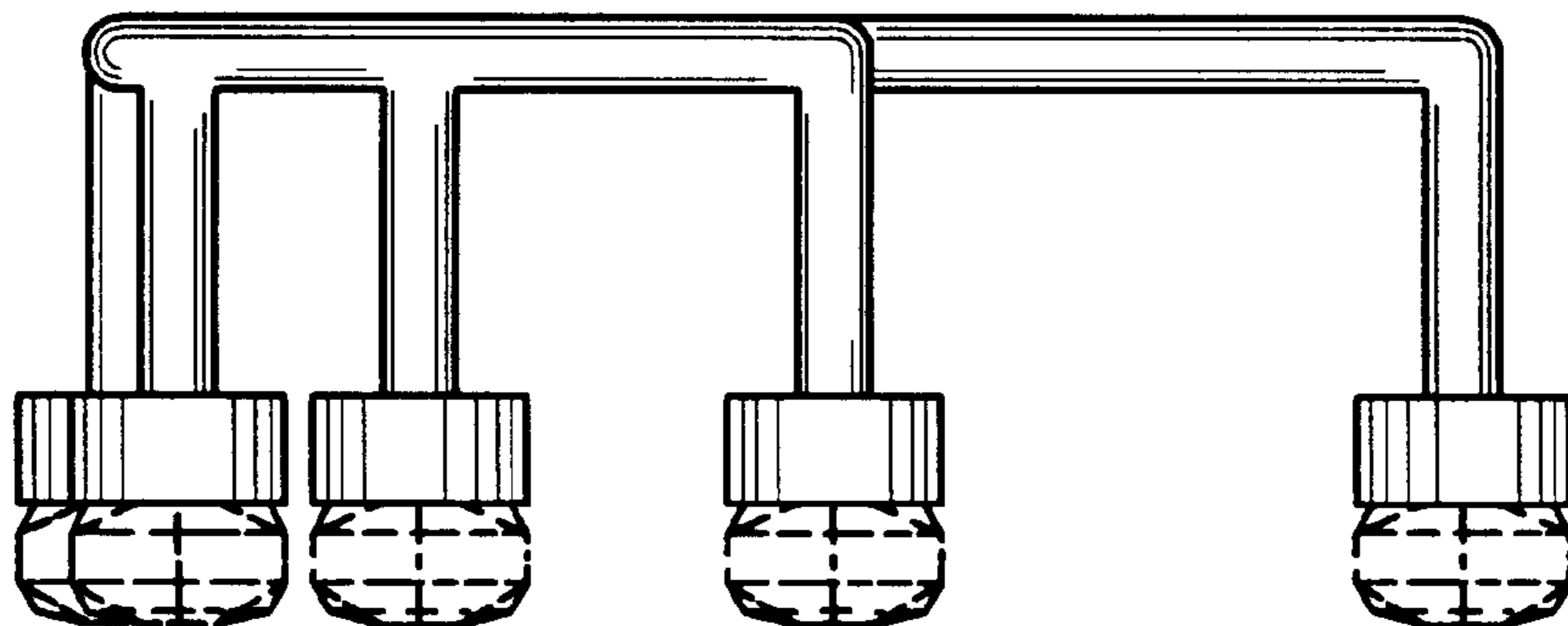

FIG. 7

