



US00D479013S

(12) **United States Design Patent**  
**Galli**

(10) **Patent No.:** **US D479,013 S**

(45) **Date of Patent:** **\*\* Aug. 26, 2003**

(54) **FLASHLIGHT HEAD**

D455,510 S \* 4/2002 Galli ..... D26/37  
D468,851 S 1/2003 Galli ..... D26/37

(76) Inventor: **Robert D. Galli**, 8176 Horseshoe Bend  
La., Las Vegas, NV (US) 89113

\* cited by examiner

(\*\*) Term: **14 Years**

*Primary Examiner*—Marcus A. Jackson  
(74) *Attorney, Agent, or Firm*—Barlow, Josephs & Holmes,  
Ltd.

(21) Appl. No.: **29/171,051**

(22) Filed: **Nov. 15, 2002**

(57) **CLAIM**

**Related U.S. Application Data**

The ornamental design for a flashlight head, as shown and  
described.

(63) Continuation-in-part of application No. 29/159,873, filed on  
Apr. 30, 2002.

**DESCRIPTION**

(51) **LOC (7) Cl.** ..... **26-02**

FIG. 1 is a perspective view showing my new design for a  
flashlight head;

(52) **U.S. Cl.** ..... **D26/37**

FIG. 2 is a top view thereof;

(58) **Field of Search** ..... D26/37-50; 362/157,  
362/158, 171, 172, 173, 183-208

FIG. 3 is a front view thereof;

FIG. 4 is a left side view thereof;

FIG. 5 is a right side view thereof;

FIG. 6 is a bottom view thereof; and,

FIG. 7 is a rear view thereof.

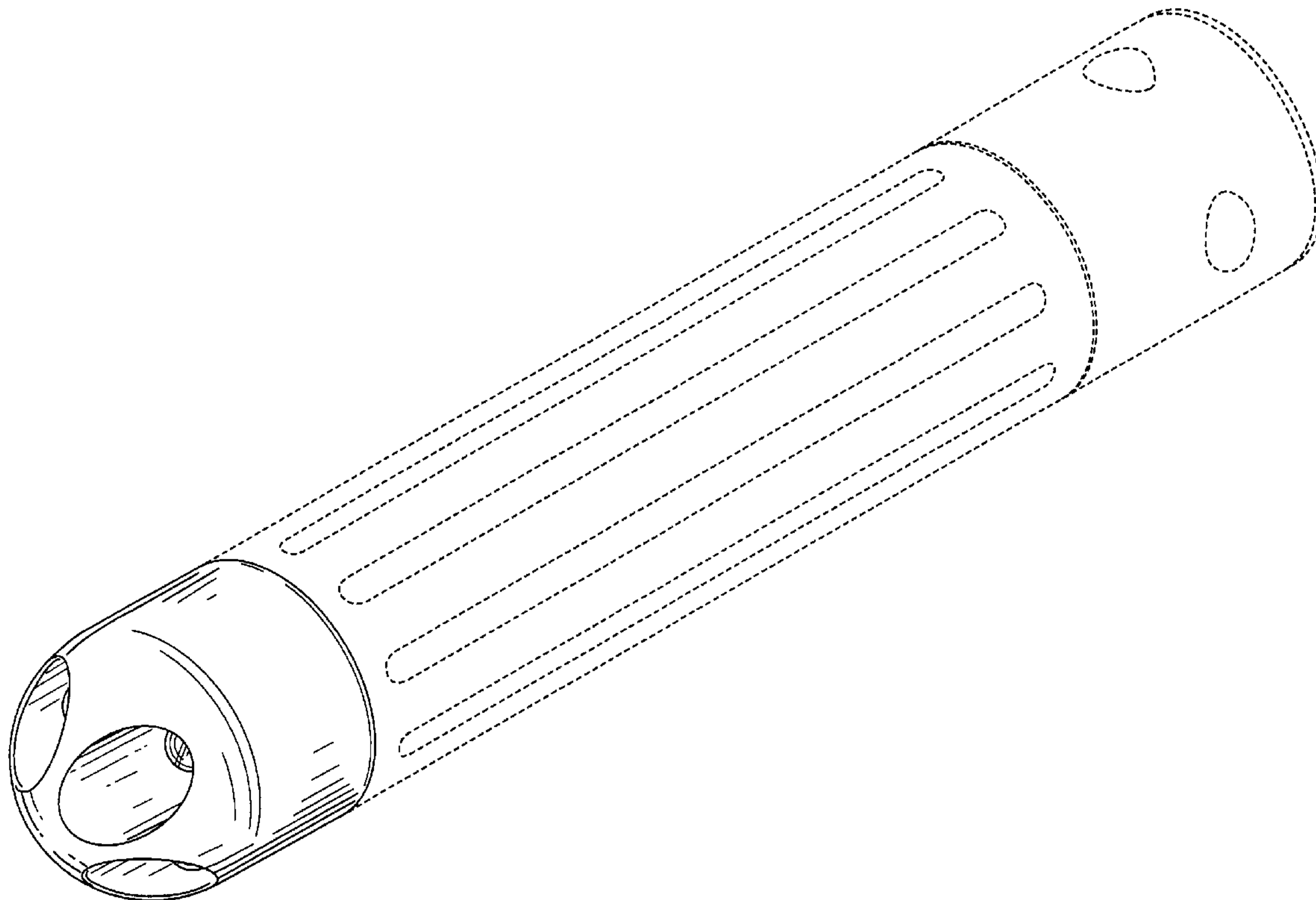
(56) **References Cited**

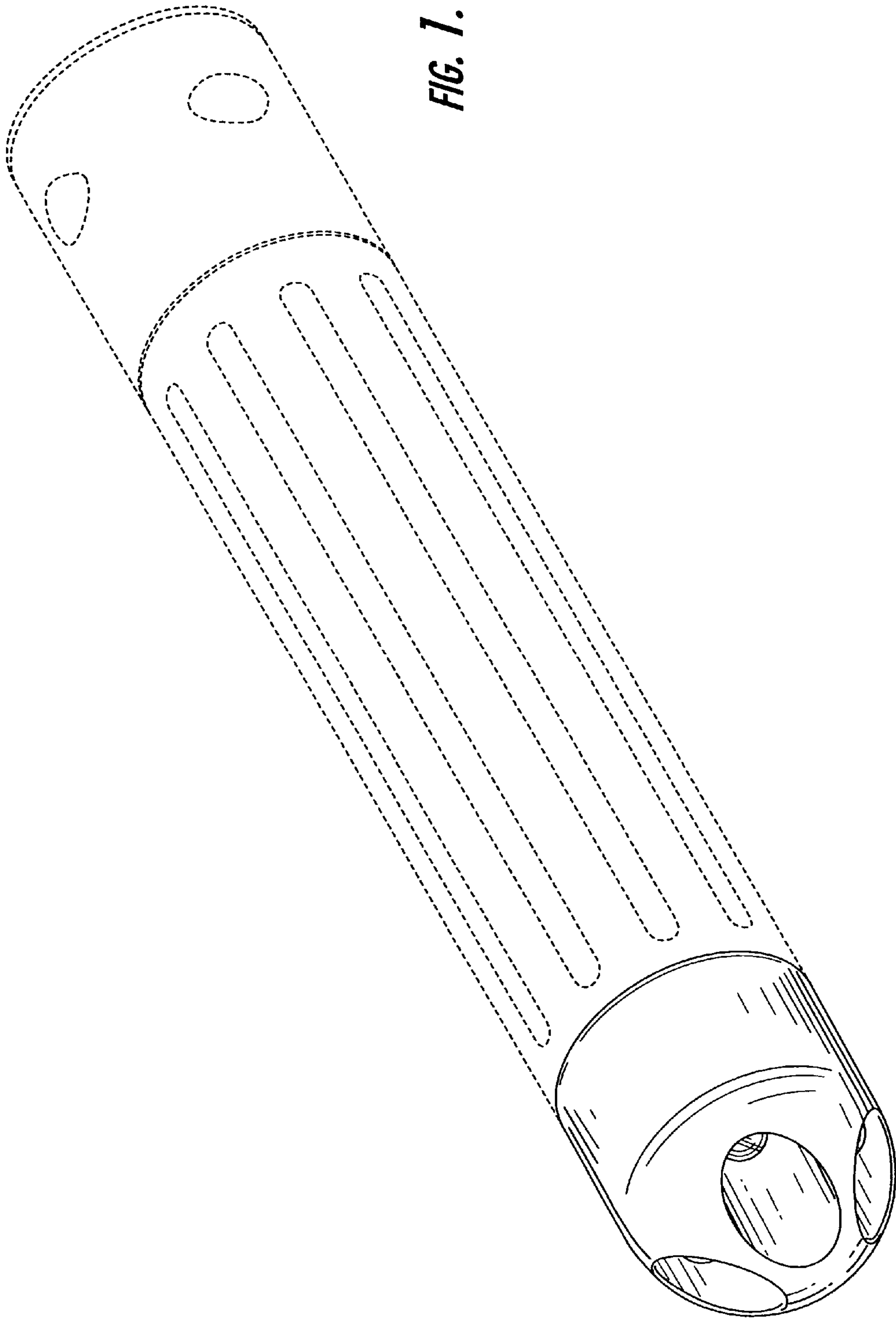
The broken lines in the drawing figures are for illustrative  
purposes only and do not form a part of the claimed design.

**U.S. PATENT DOCUMENTS**

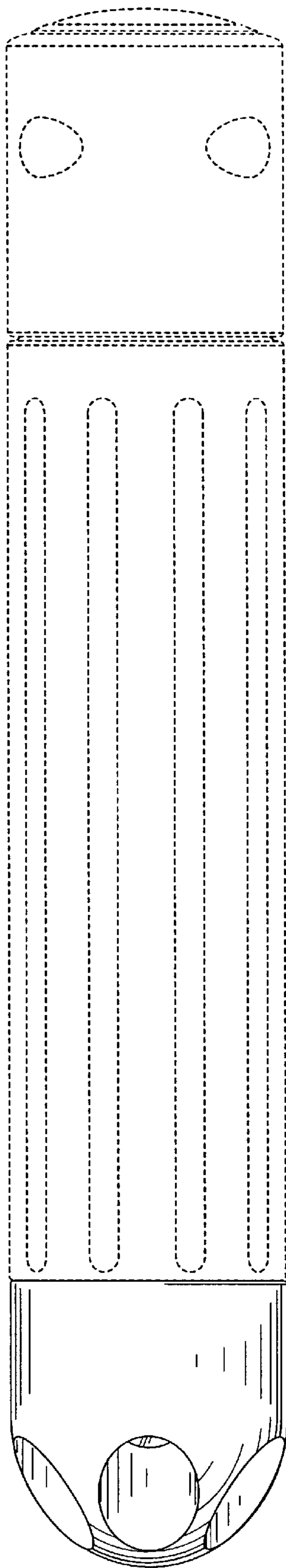
D351,672 S 10/1994 Tsay ..... D26/37  
D421,657 S \* 3/2000 Siebert ..... D26/37  
D428,504 S \* 7/2000 Saunders ..... D26/49  
D434,164 S \* 11/2000 Galli ..... D26/49

**1 Claim, 4 Drawing Sheets**

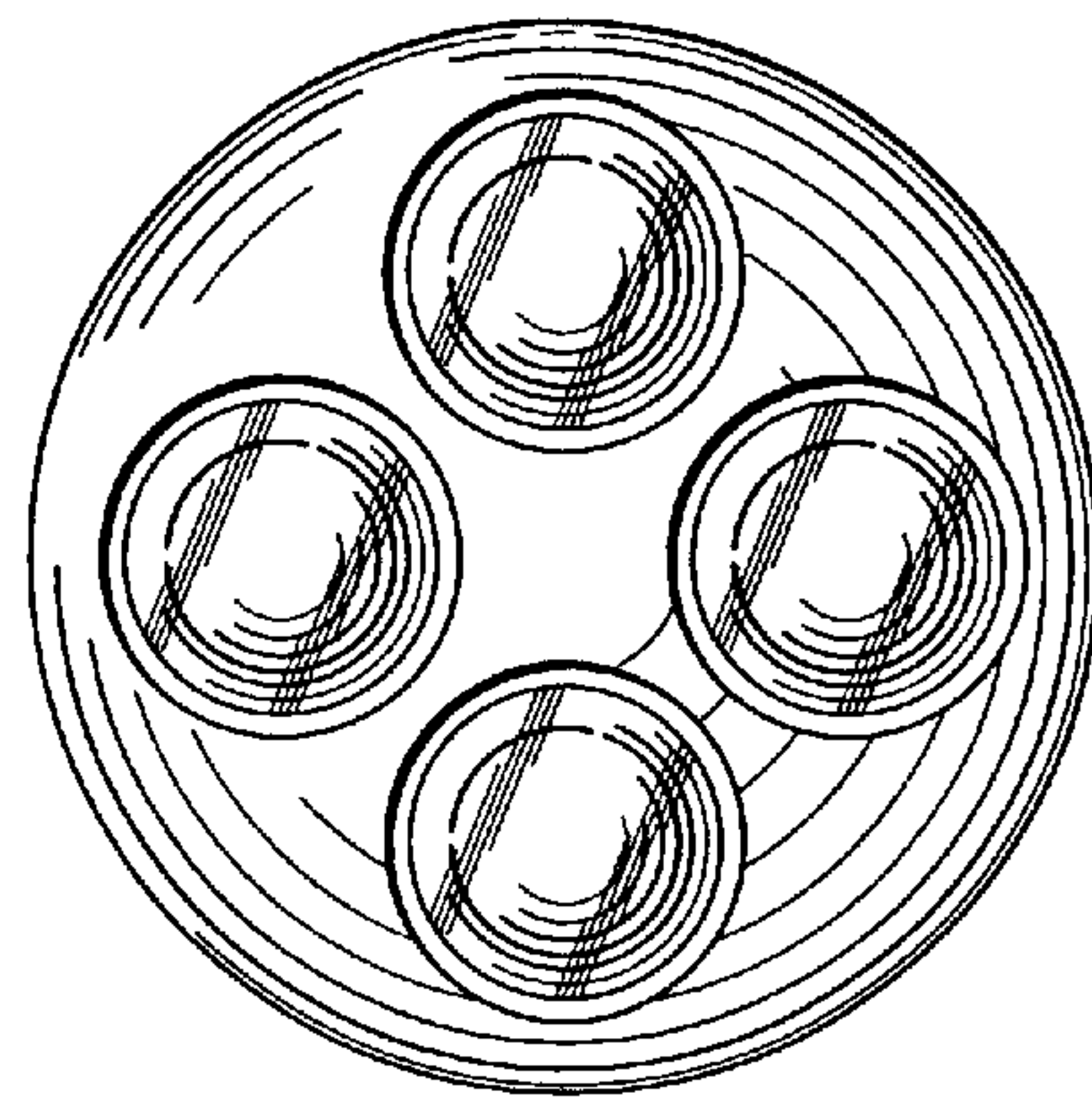




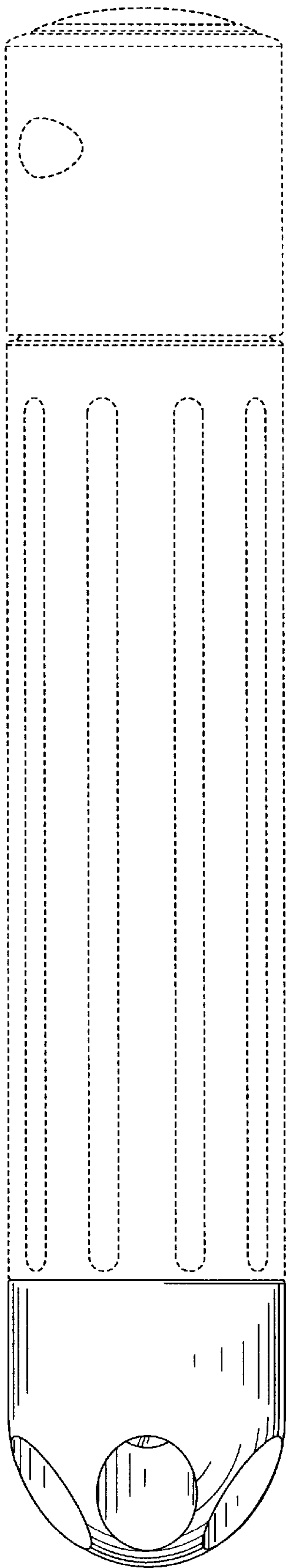
*FIG. 1.*



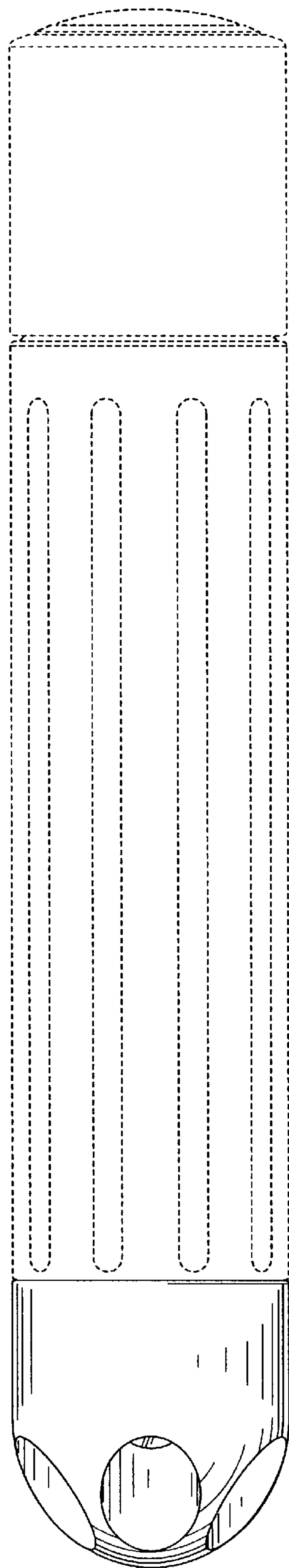
**FIG. 2.**



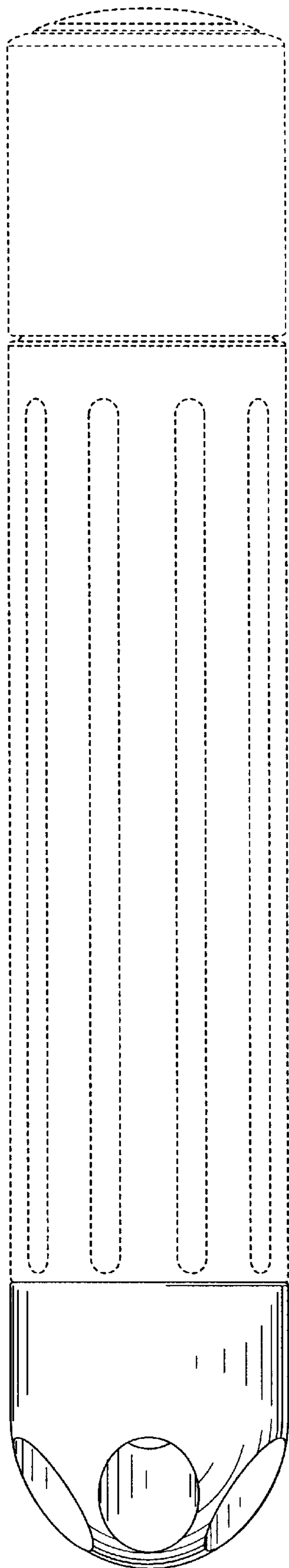
**FIG. 3.**



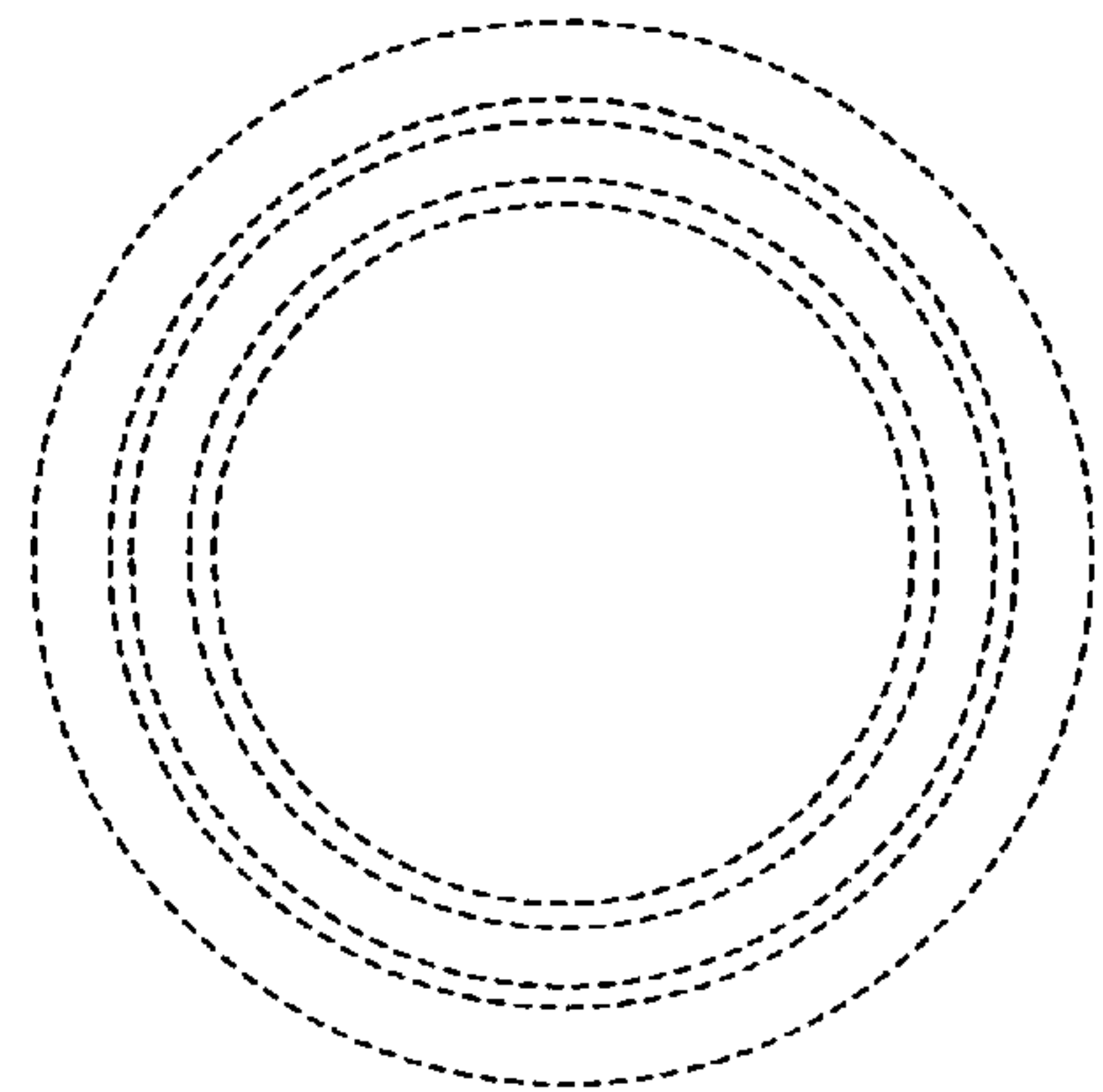
*FIG. 4.*



*FIG. 5.*



*FIG. 6.*



*FIG. 7.*