



US00D478987S

(12) **United States Design Patent**
Groenke et al.

(10) **Patent No.:** **US D478,987 S**

(45) **Date of Patent:** **** Aug. 26, 2003**

(54) **BIOPSY DEVICE**

(75) Inventors: **Gregory C. Groenke**, Gurnee, IL (US);
Michael Plishka, Northbrook, IL (US)

(73) Assignee: **Allegiance Corporation**, McGaw Park,
IL (US)

(**) Term: **14 Years**

(21) Appl. No.: **29/158,584**

(22) Filed: **Apr. 5, 2002**

(51) **LOC (7) Cl.** **24-02**

(52) **U.S. Cl.** **D24/146; D24/147**

(58) **Field of Search** D24/146, 133,
D24/147, 114; 606/170, 208, 207; 600/564,
566, 567

(56) **References Cited**

U.S. PATENT DOCUMENTS

4,655,226 A	4/1987	Lee	128/754
4,815,476 A	3/1989	Clossick	128/751
4,961,430 A	10/1990	Sheahon	128/754
5,052,402 A	10/1991	Bencini et al.	128/751
5,094,247 A	3/1992	Hernandez et al.	128/751
5,100,430 A	3/1992	Avellanet et al.	606/205
5,172,700 A	12/1992	Bencini et al.	128/751
5,238,002 A	8/1993	Devlin et al.	128/751
5,313,958 A	5/1994	Bauer	128/754
5,458,112 A	10/1995	Weaver	128/753
5,651,372 A	7/1997	Caillouette	128/753

5,807,275 A	9/1998	Jamshidi	600/567
5,810,744 A	9/1998	Chu et al.	600/567
5,833,668 A	11/1998	Aguilar	604/227
5,902,278 A	5/1999	Aguilar	604/227
5,971,939 A	* 10/1999	DeSantis et al.	600/564
5,971,940 A	10/1999	Baker et al.	600/567
6,083,150 A	7/2000	Aznoian et al.	600/56
6,129,740 A	10/2000	Michelson	606/205
6,149,607 A	11/2000	Simpson et al.	600/567
6,165,136 A	* 12/2000	Nishtala	600/564
6,176,823 B1	1/2001	Foley et al.	600/114
6,280,399 B1	* 8/2001	Rossin et al.	600/567
6,394,964 B1	* 5/2002	Sievert et al.	600/564

* cited by examiner

Primary Examiner—Ian Simmons

(74) *Attorney, Agent, or Firm*—Andrew G. Rozycki

(57) **CLAIM**

We claim the ornamental design for the biopsy device, as shown and described.

DESCRIPTION

FIG. 1 is an angled side view perspective of the biopsy device;

FIG. 2 is a front view of the biopsy device;

FIG. 3 is a back view of the biopsy device;

FIG. 4 is a left side view of the biopsy device;

FIG. 5 is a right side view of the biopsy device;

FIG. 6 is a top view of the biopsy device; and,

FIG. 7 is a bottom view of the biopsy device.

1 Claim, 7 Drawing Sheets

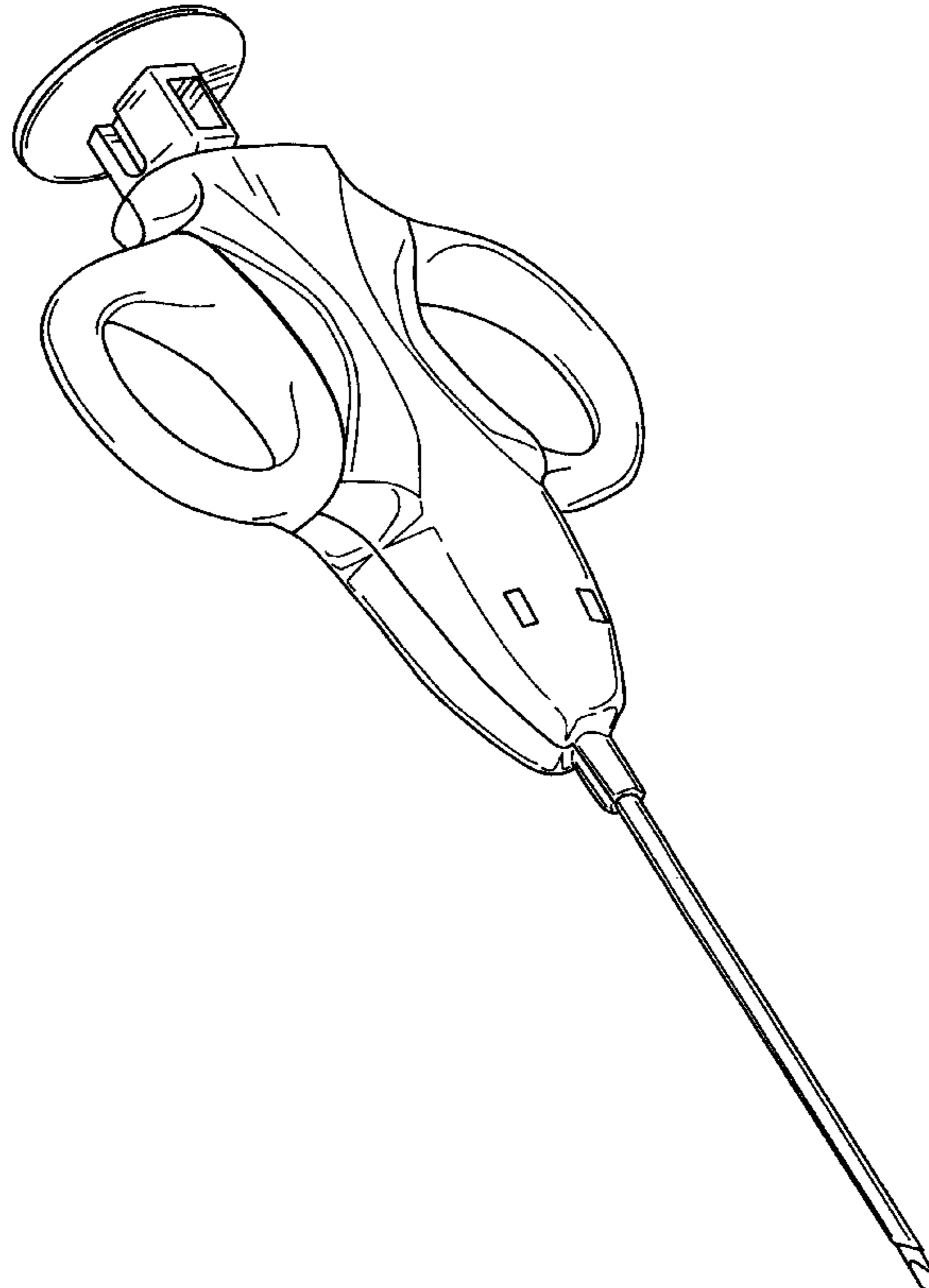

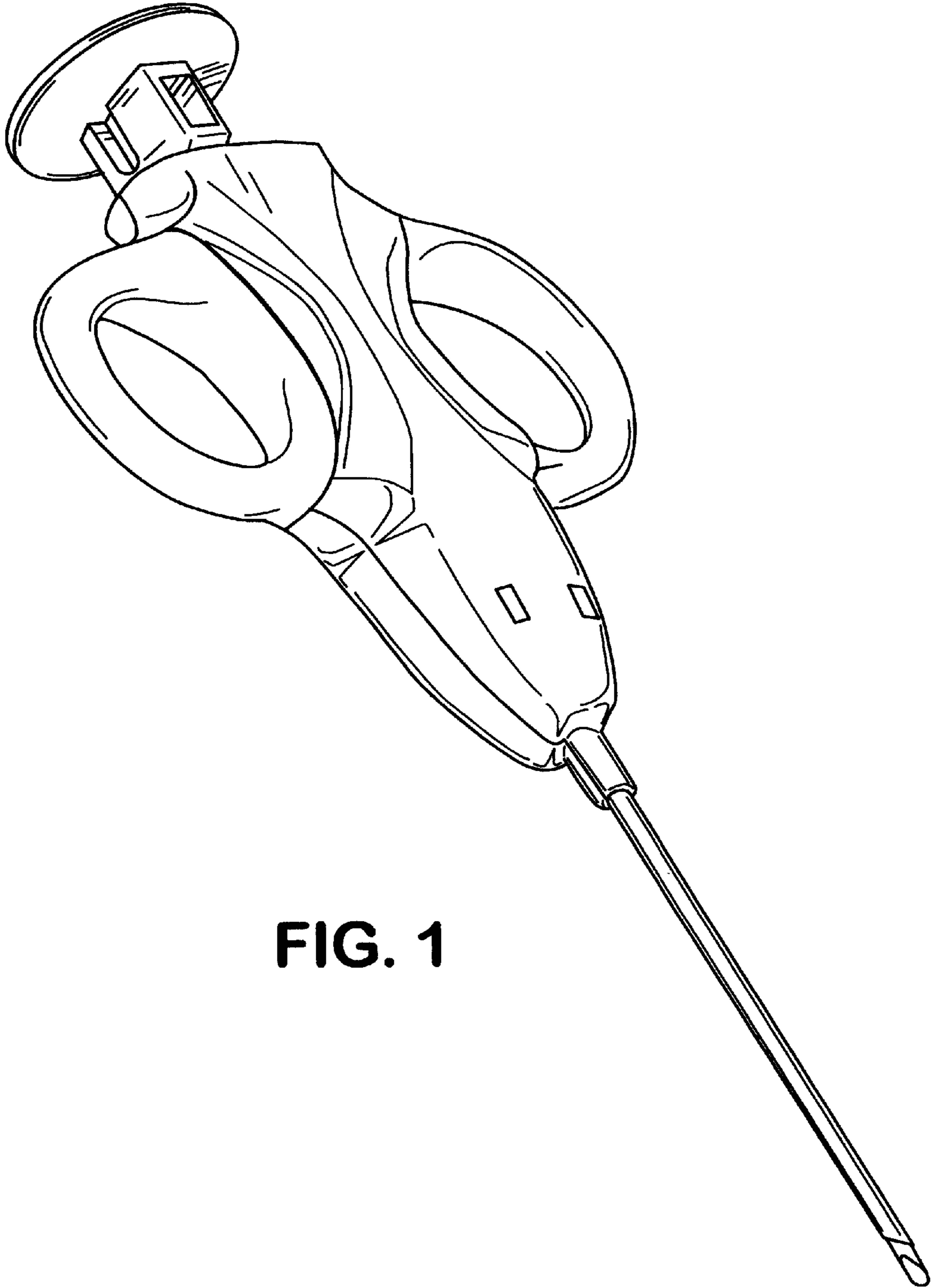
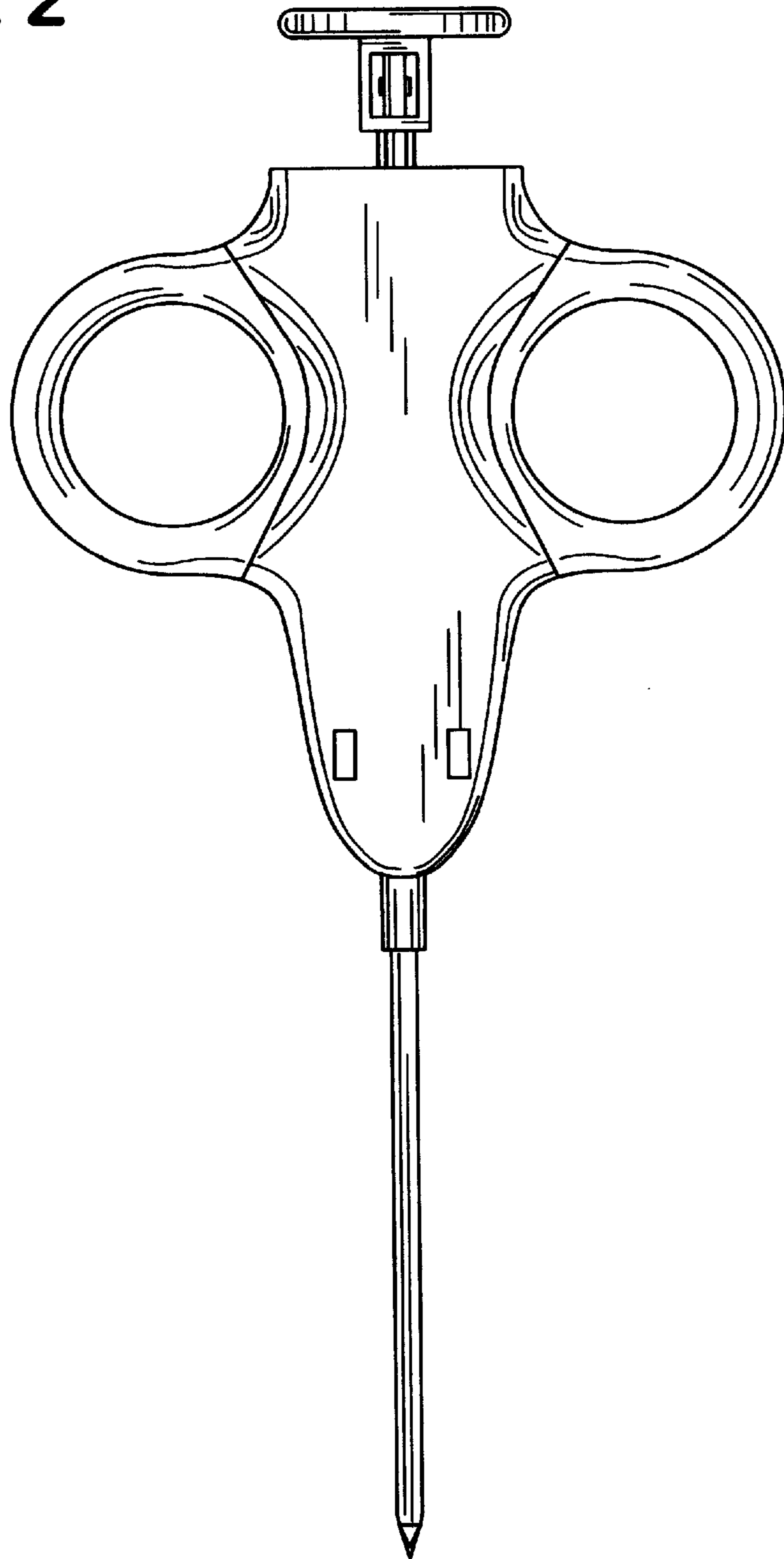

FIG. 1

FIG. 2



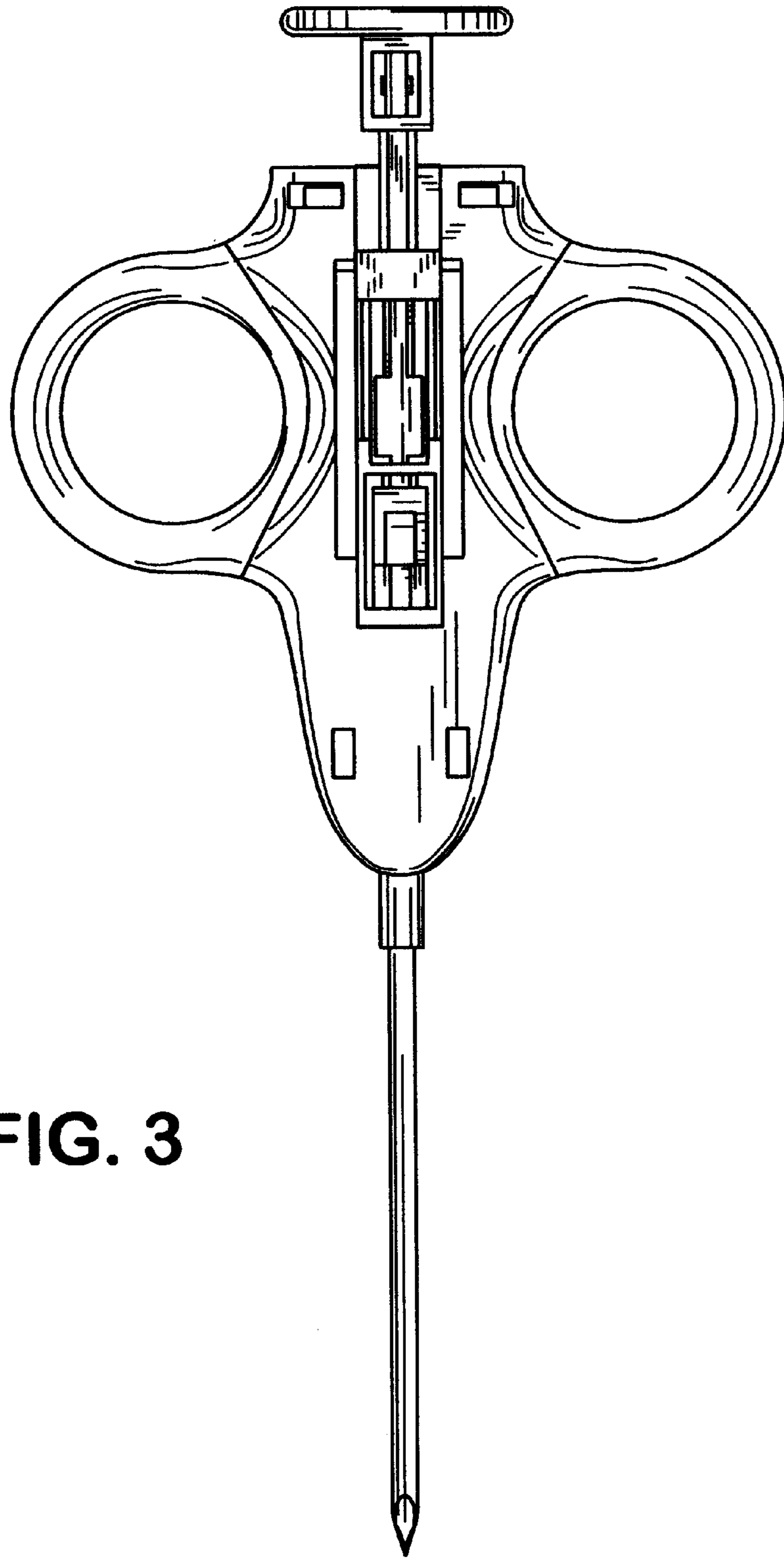

FIG. 3

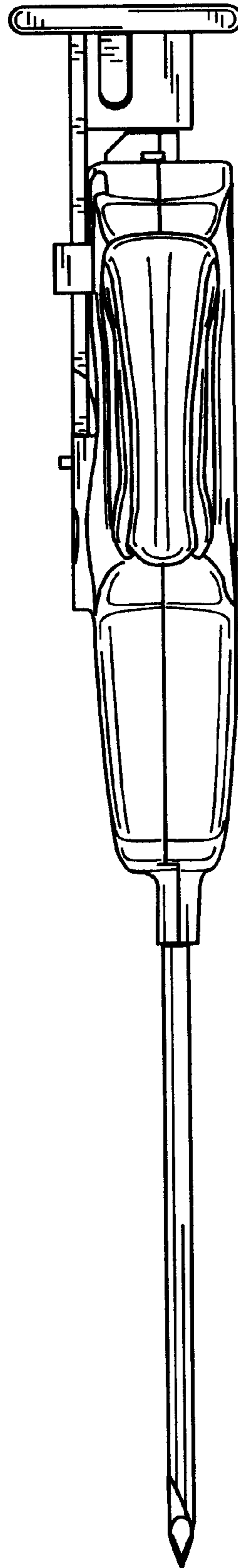

FIG. 4

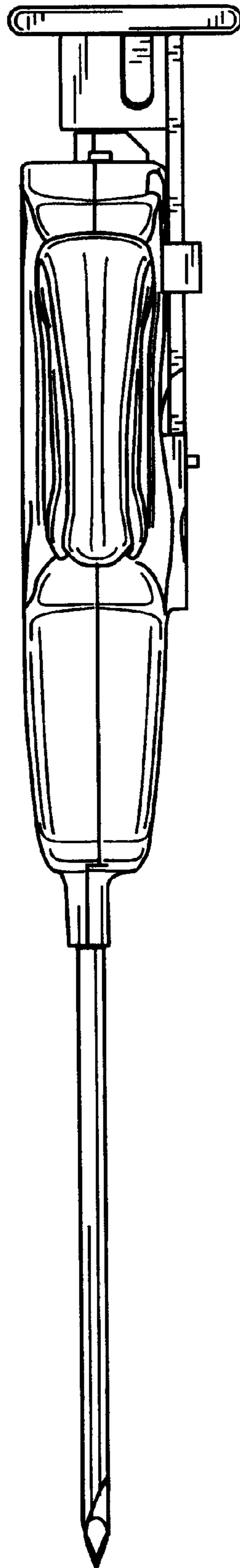

FIG. 5

FIG. 6

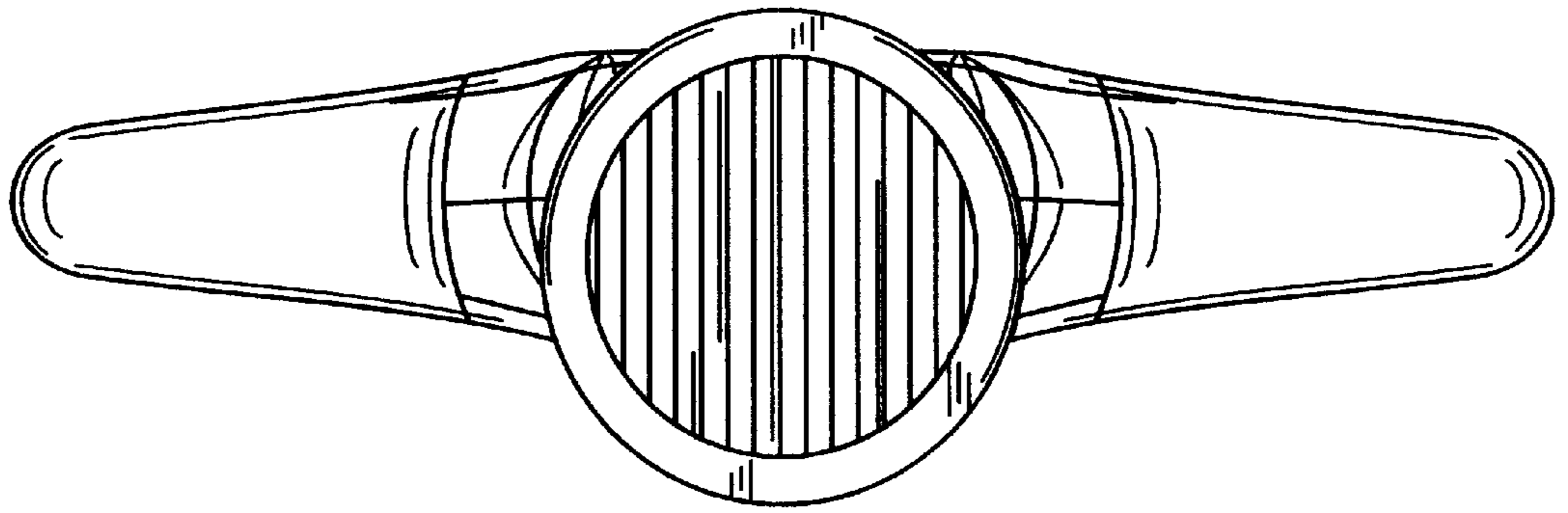

FIG. 7

