



US00D478949S

(12) **United States Design Patent**
DeLaCruz

(10) **Patent No.:** **US D478,949 S**

(45) **Date of Patent:** **** Aug. 26, 2003**

(54) **GOLF WEDGE WITH HEEL AND TOE CUT-OUTS**

D399,277 S * 10/1998 Ezaki D21/747
D415,535 S * 10/1999 Heidel D21/385

(76) **Inventor:** **Richard DeLaCruz**, 2260 Rutherford Rd., Suite 109, Carlsbad, CA (US) 92008

* cited by examiner

Primary Examiner—Mitchell Siegel
(74) *Attorney, Agent, or Firm*—Steven W. Webb

(**) **Term:** **14 Years**

(57) **CLAIM**

(21) **Appl. No.:** **29/168,216**

The ornamental design for a golf wedge with heel and toe cut-outs, as shown and described

(22) **Filed:** **Sep. 30, 2002**

DESCRIPTION

(51) **LOC (7) Cl.** **21-02**

(52) **U.S. Cl.** **D21/747**

(58) **Field of Search** D21/747-751;
473/324, 327-331, 350

FIG. 1 is a perspective view of the golf wedge.
FIG. 2 is a face side view of the golf wedge.
FIG. 3 is a bottom view of the golf wedge.
FIG. 4 is a trailing edge view of the golf wedge.
FIG. 5 is a leading edge view of the golf wedge.
FIG. 6 is a back side view of the golf wedge; and,
FIG. 7 is a top view of the golf wedge.

(56) **References Cited**

U.S. PATENT DOCUMENTS

D395,476 S * 6/1998 Pond et al. D21/747
D399,276 S * 10/1998 Hettinger et al. D21/747

1 Claim, 3 Drawing Sheets

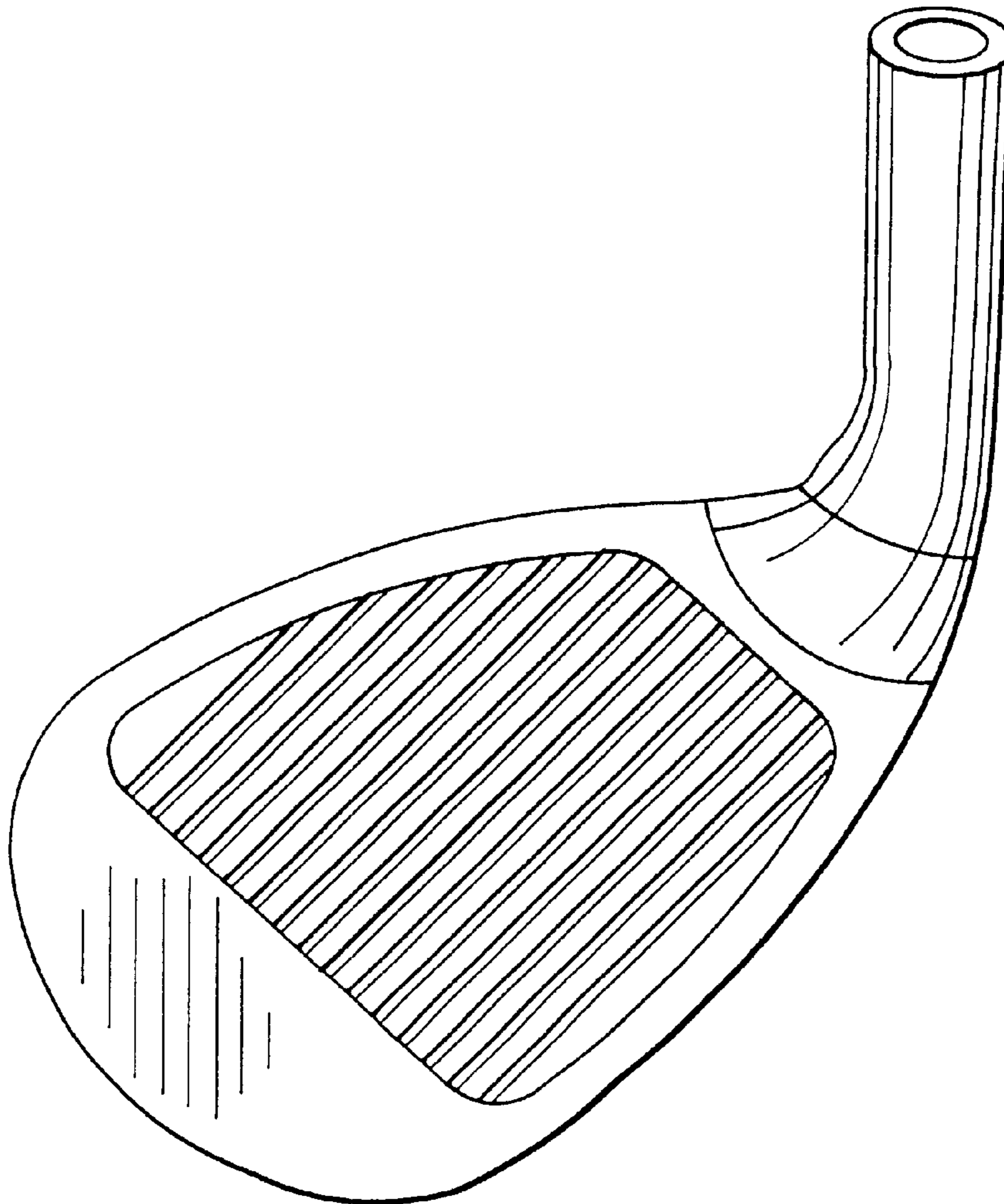

Fig. 1

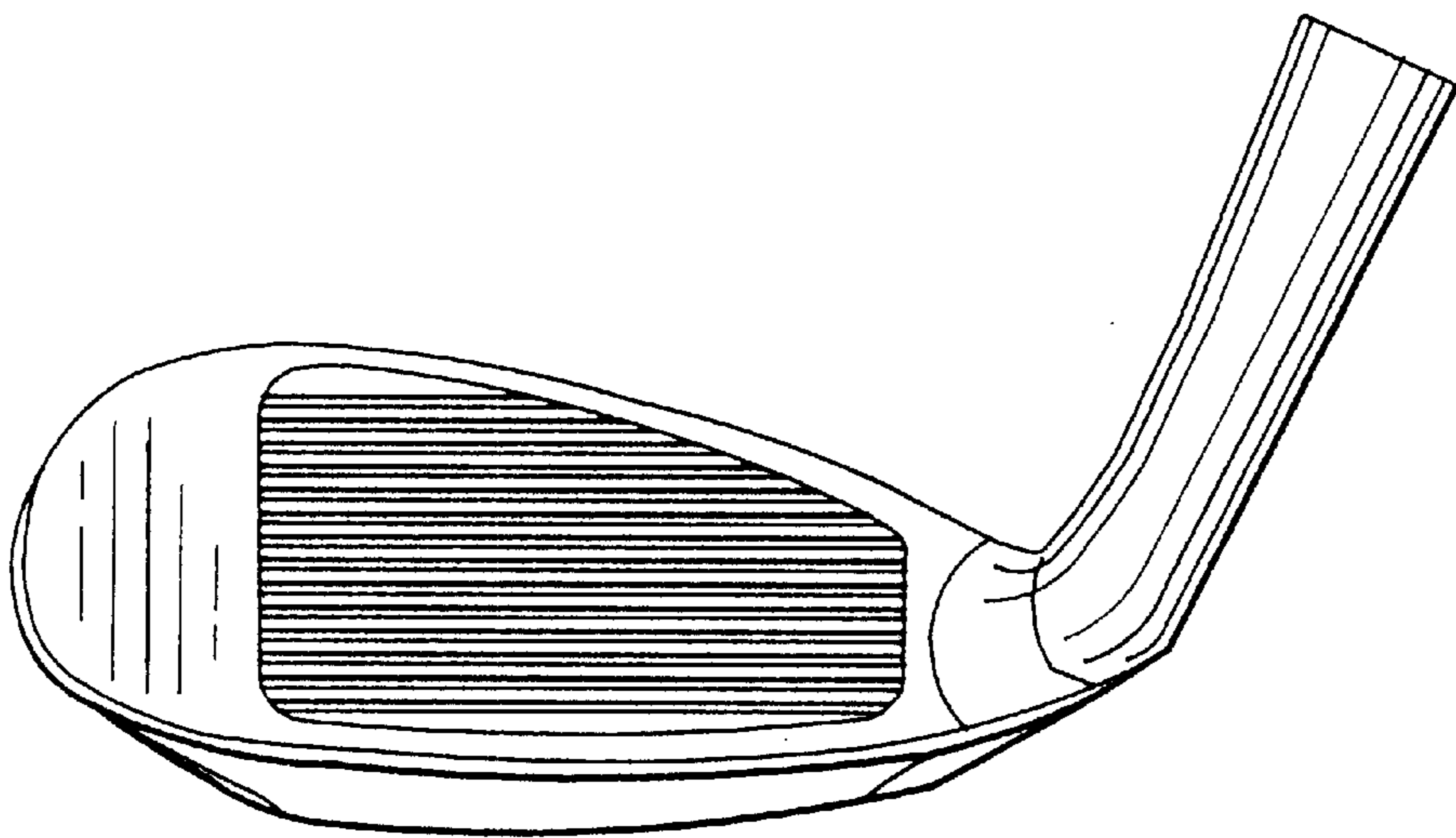
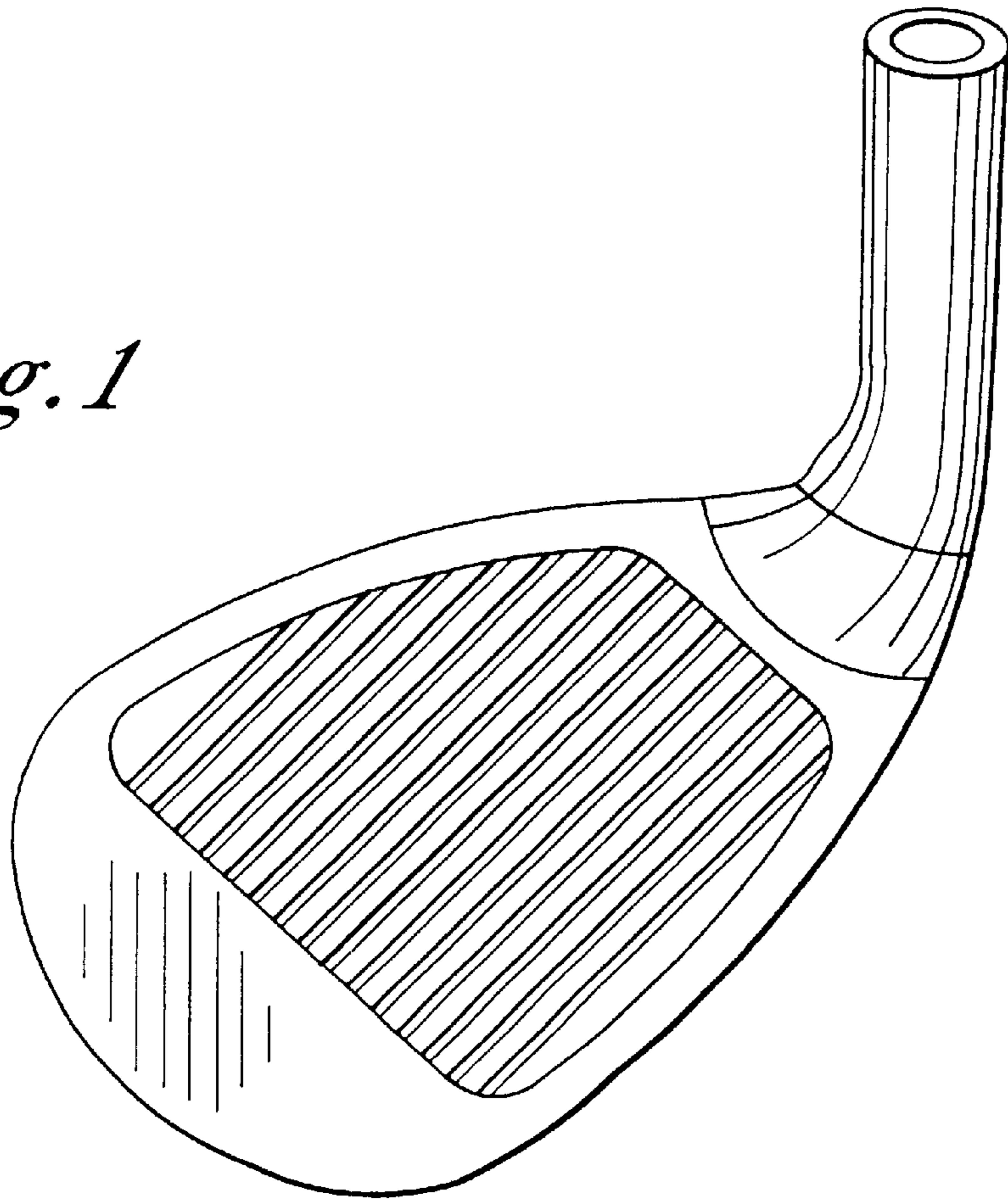

Fig. 2

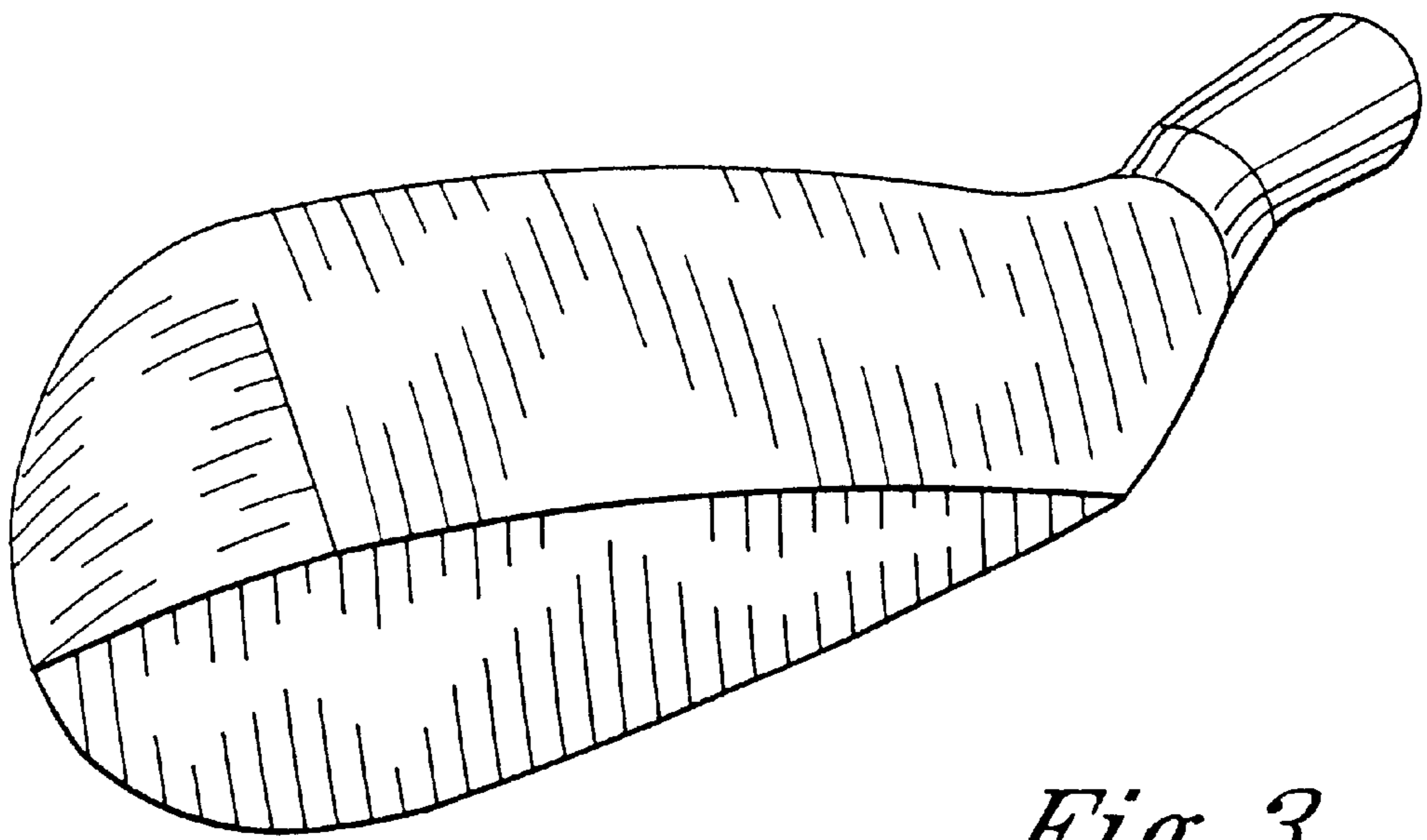

Fig. 3

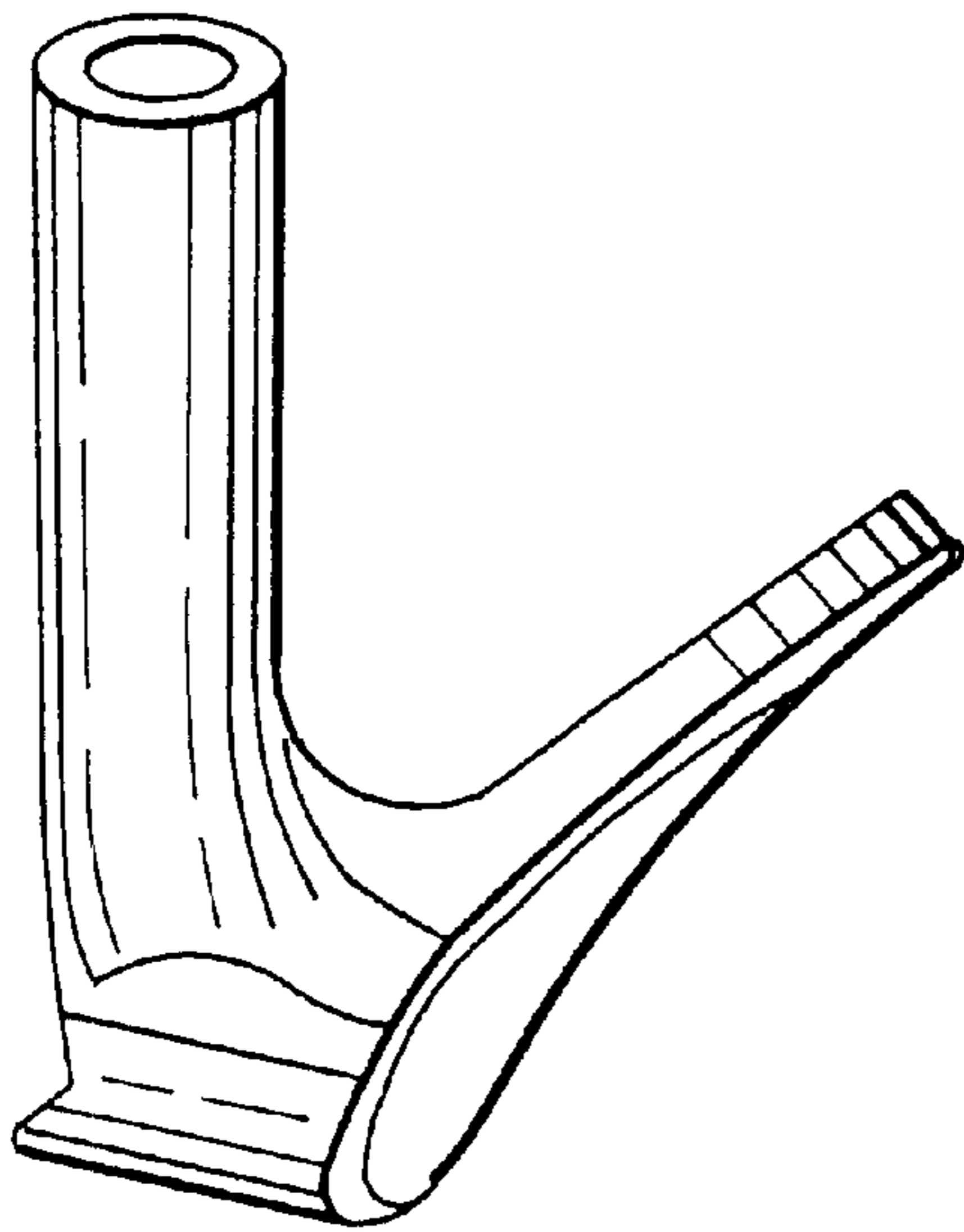

Fig. 4

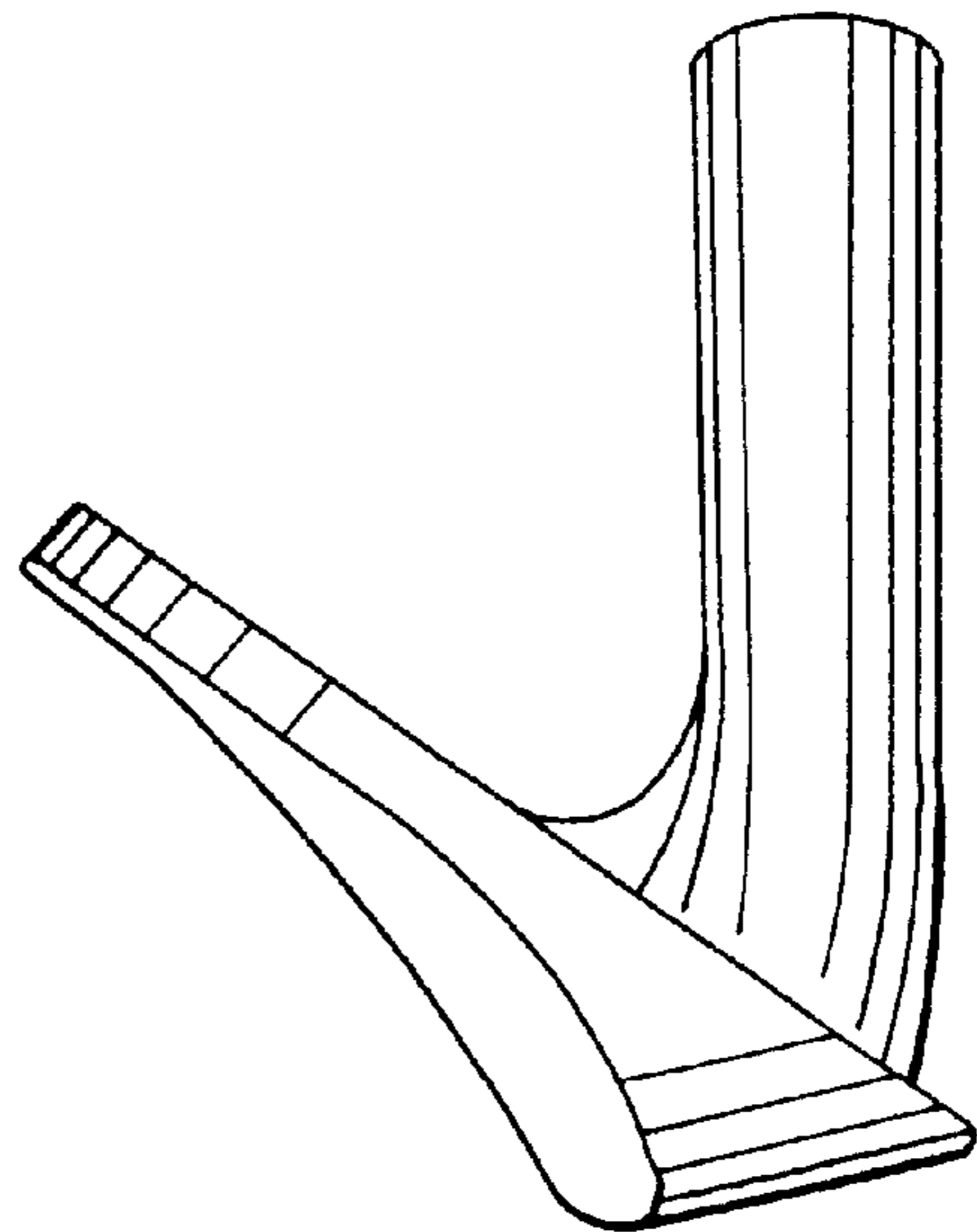

Fig. 5

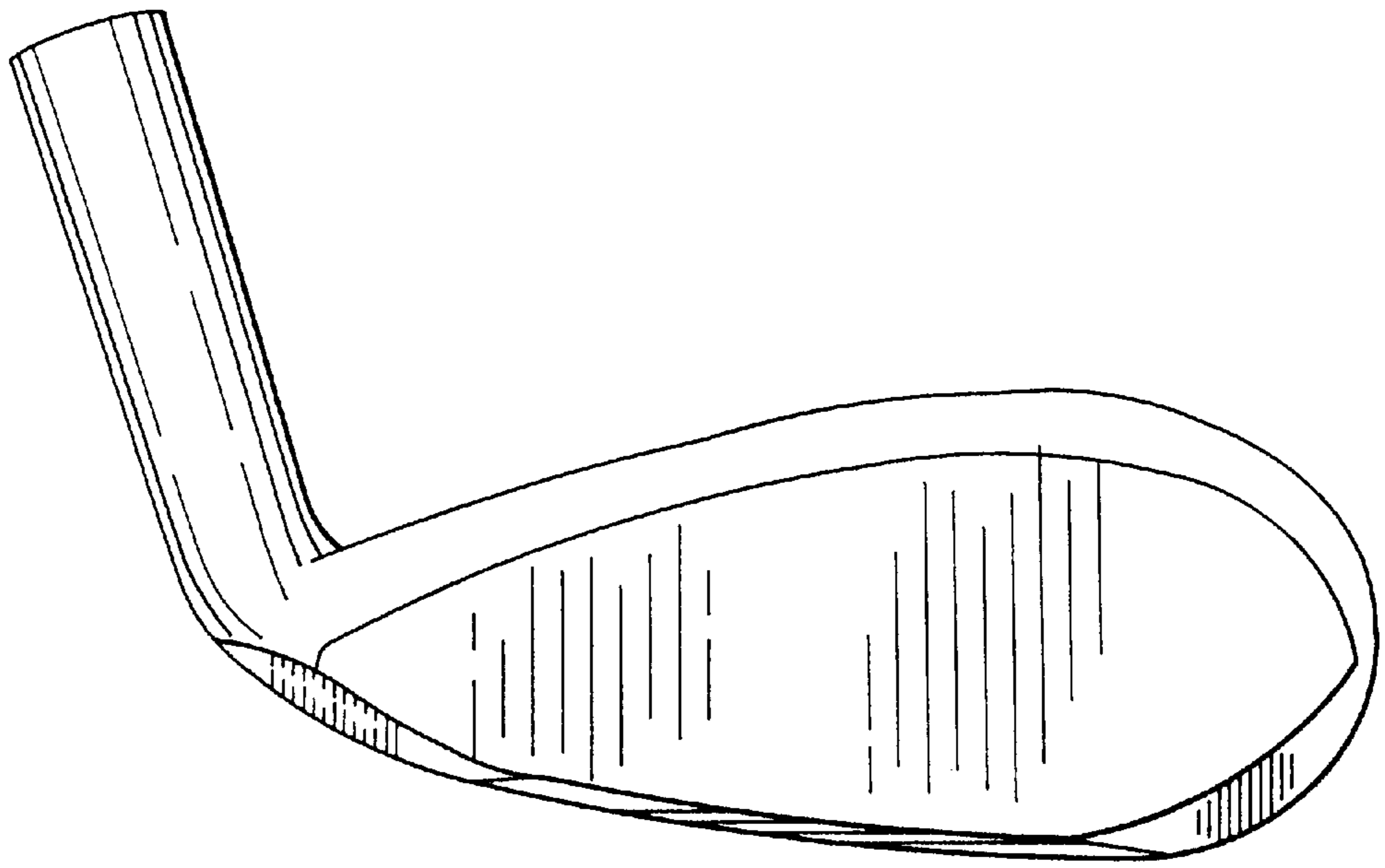

Fig. 6

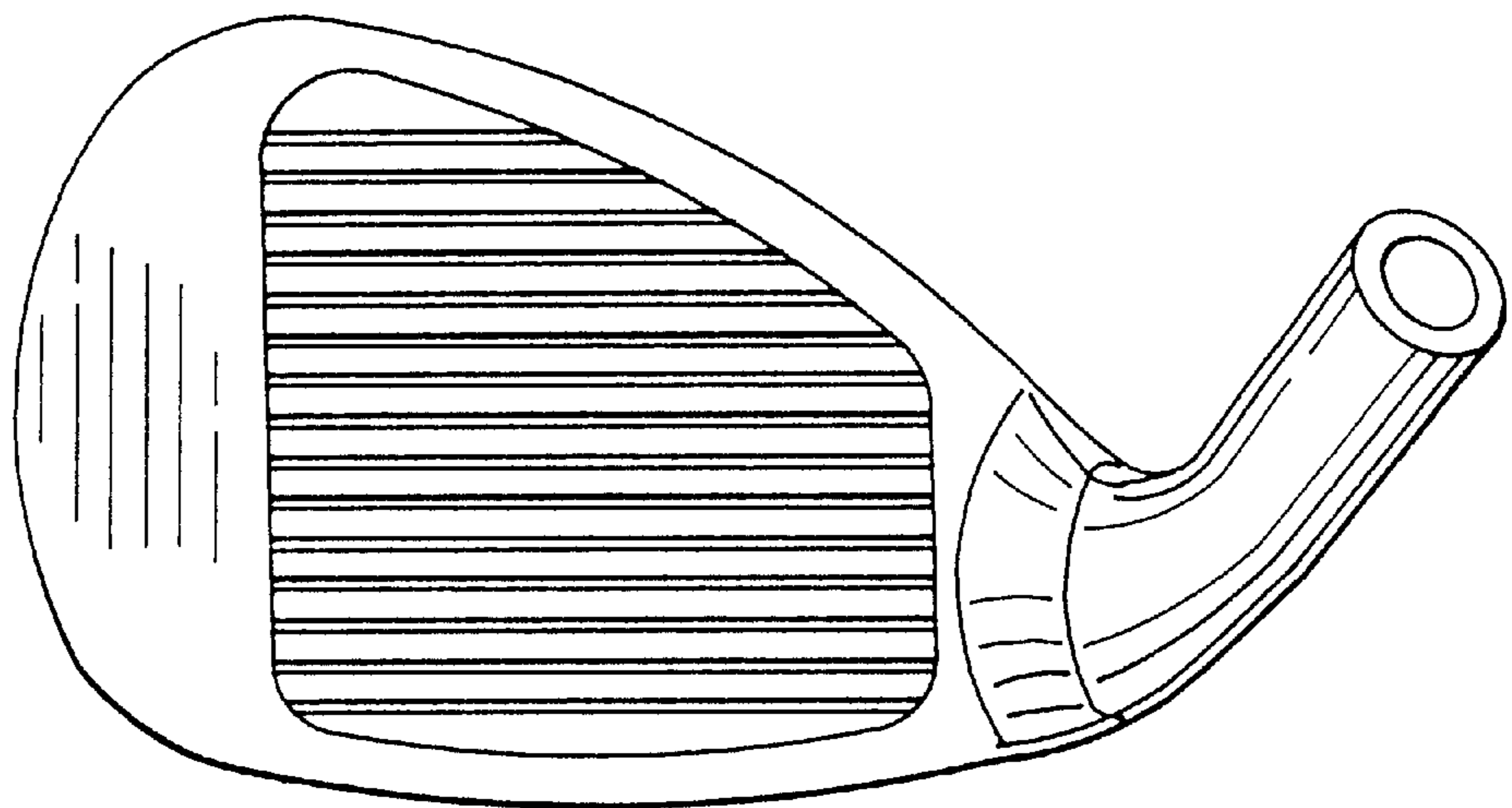

Fig. 7