



US00D478887S

(12) **United States Design Patent**
Jerome

(10) **Patent No.:** **US D478,887 S**

(45) **Date of Patent:** **** Aug. 26, 2003**

(54) **PORTABLE MP-3 CD PLAYER WITH GAMING DEVICE**

(75) Inventor: **Michael Jerome**, Hong Kong (CN)

(73) Assignee: **Koninklijke Philips Electronics N.V.**, Eindhoven (NL)

(**) Term: **14 Years**

(21) Appl. No.: **29/169,889**

(22) Filed: **Oct. 28, 2002**

(51) **LOC (7) Cl.** **14-01**

(52) **U.S. Cl.** **D14/156; D14/168; D21/329**

(58) **Field of Search** **D14/135-136, D14/156-157, 167-168, 188, 193-198, 257-258; D21/324, 329; 369/75.1, 75.2, 77.1, 77.2; 455/344, 347, 350-351; 463/1, 29-35, 46-47**

(56) **References Cited**

U.S. PATENT DOCUMENTS

D425,571 S * 5/2000 Goto D21/329

D431,544 S * 10/2000 Kobayashi D14/156

D433,672 S * 11/2000 Kobayashi D14/156

6,227,966 B1 * 5/2001 Yokoi 463/1

D451,489 S * 12/2001 Martres D14/156

D451,490 S * 12/2001 Martres D14/156

* cited by examiner

Primary Examiner—Nanda Bondade

(74) *Attorney, Agent, or Firm*—Ernestine C. Bartlett

(57) **CLAIM**

The ornamental design for a portable MP-3 CD player with gaming device, as shown.

DESCRIPTION

FIG. 1 is a perspective view showing my design; FIG. 2 is a front elevational view thereof; FIG. 3 is a rear elevational view thereof; FIG. 4 is a left side elevational view thereof; FIG. 5 is a right side elevational view thereof; FIG. 6 is a top plan view thereof; and, FIG. 7 is a bottom plan view thereof.

1 Claim, 5 Drawing Sheets

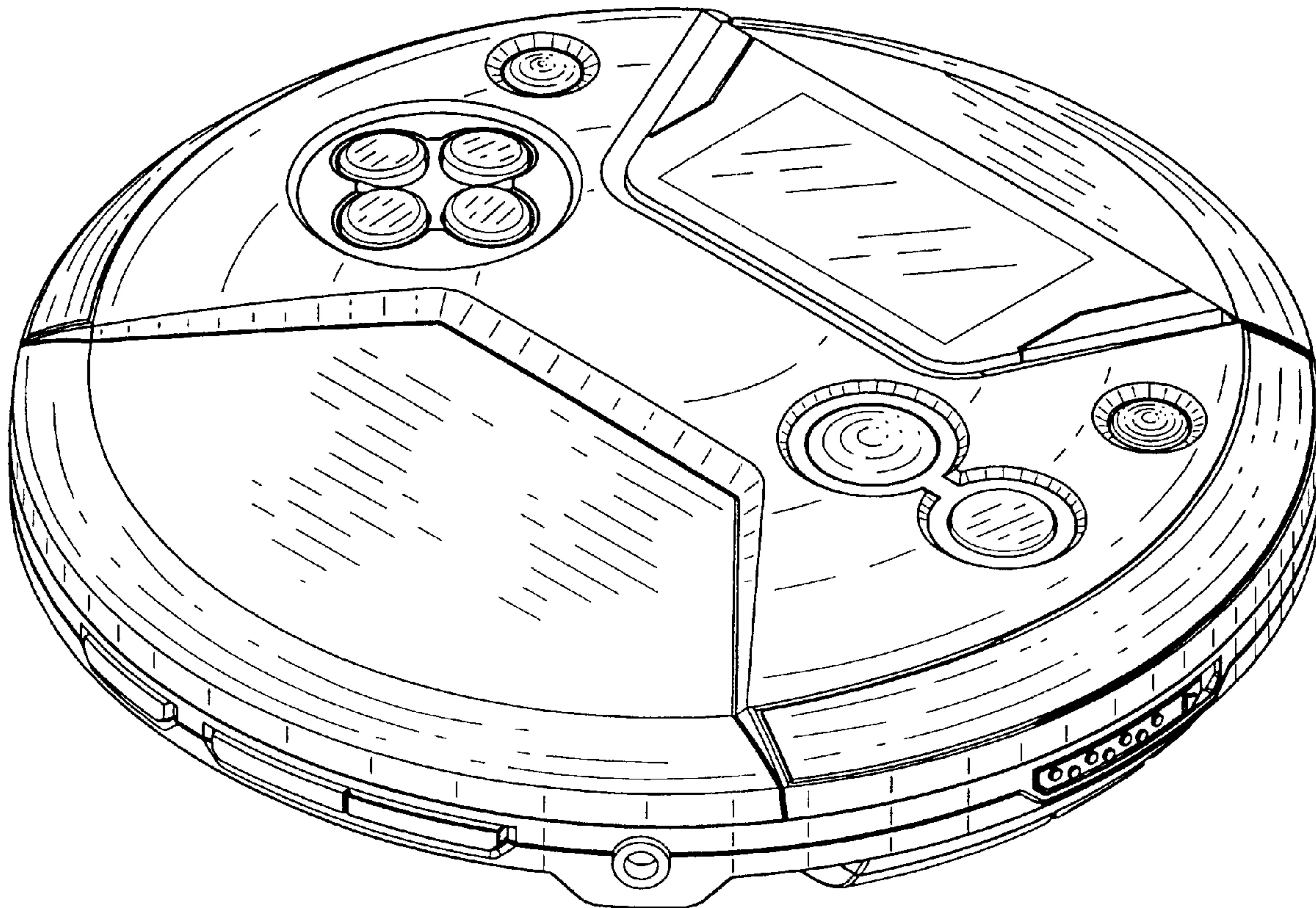

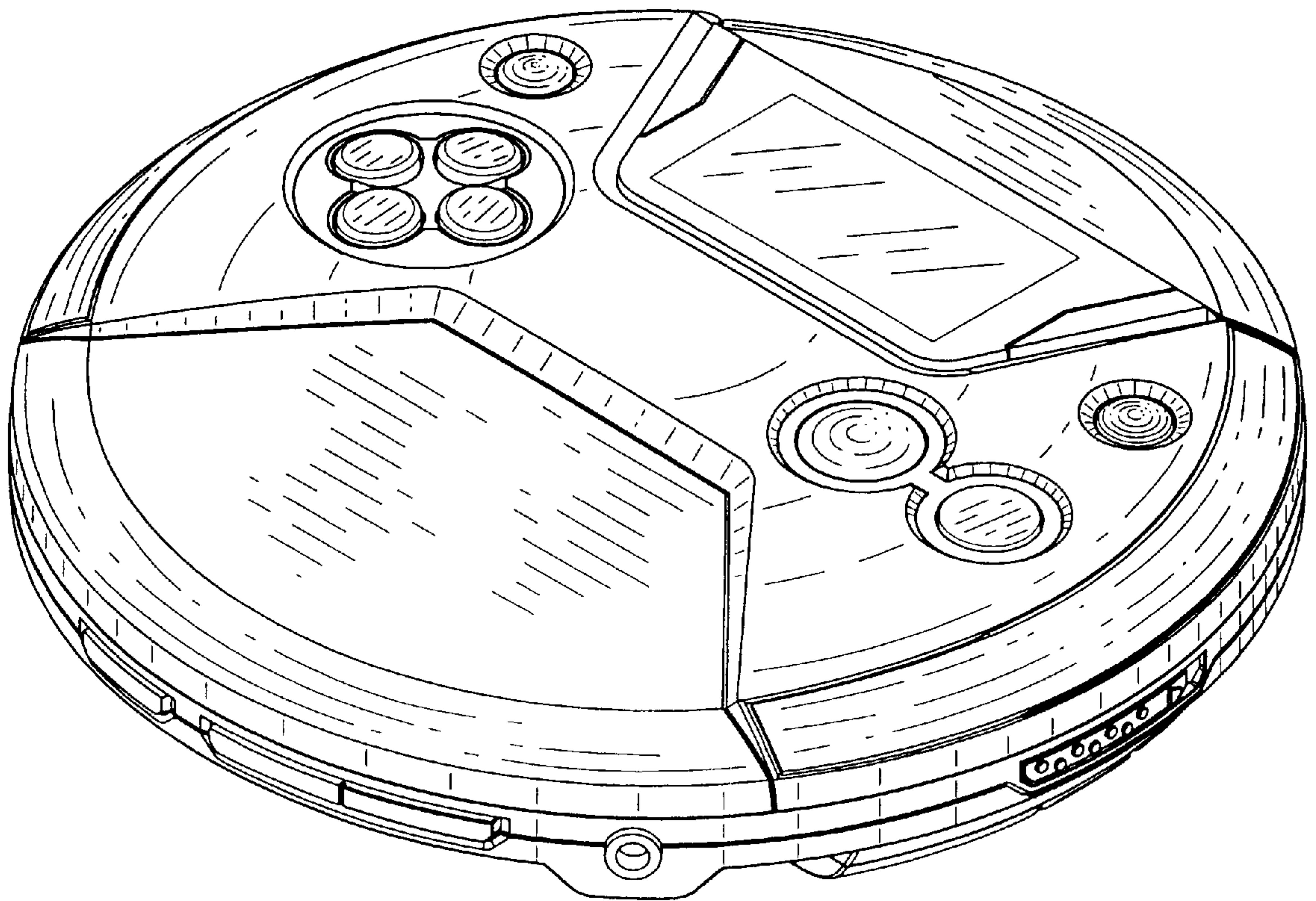

FIG. 1

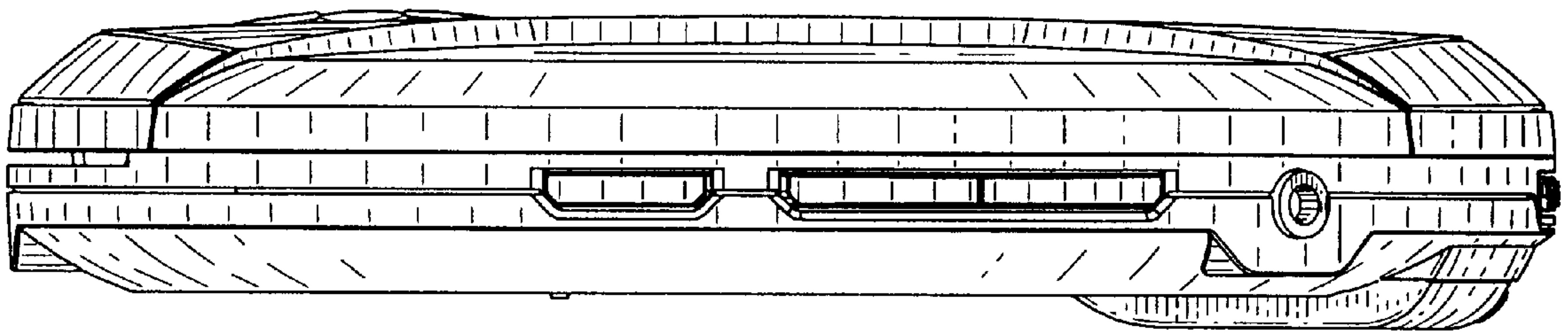

FIG. 2

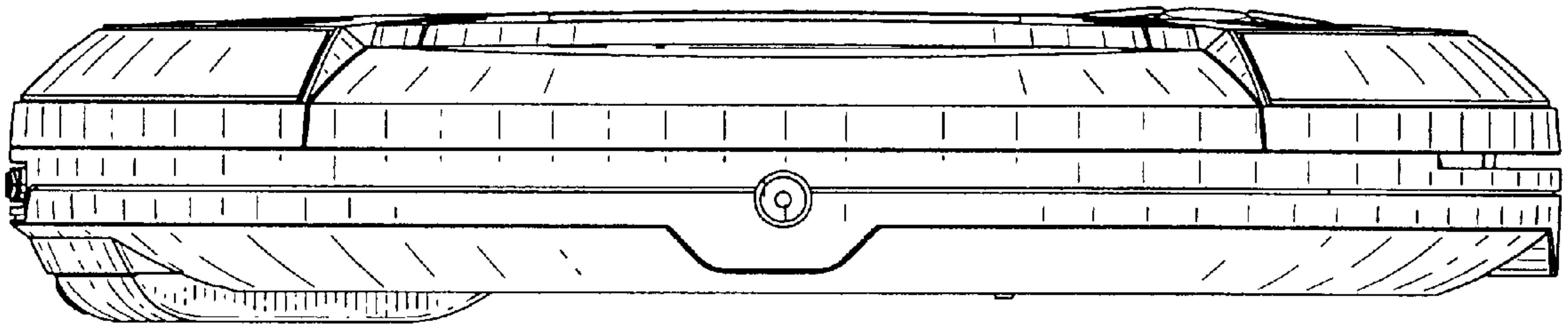

FIG. 3

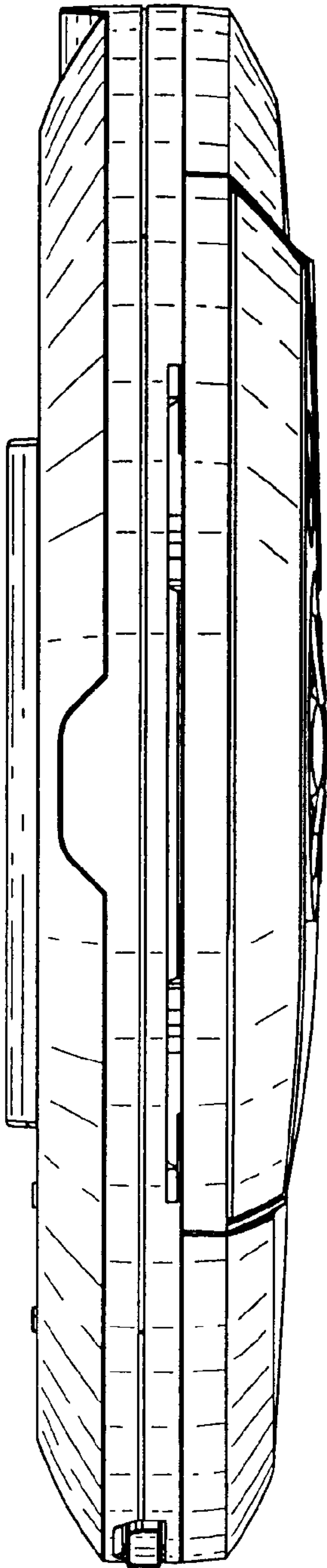

FIG. 4

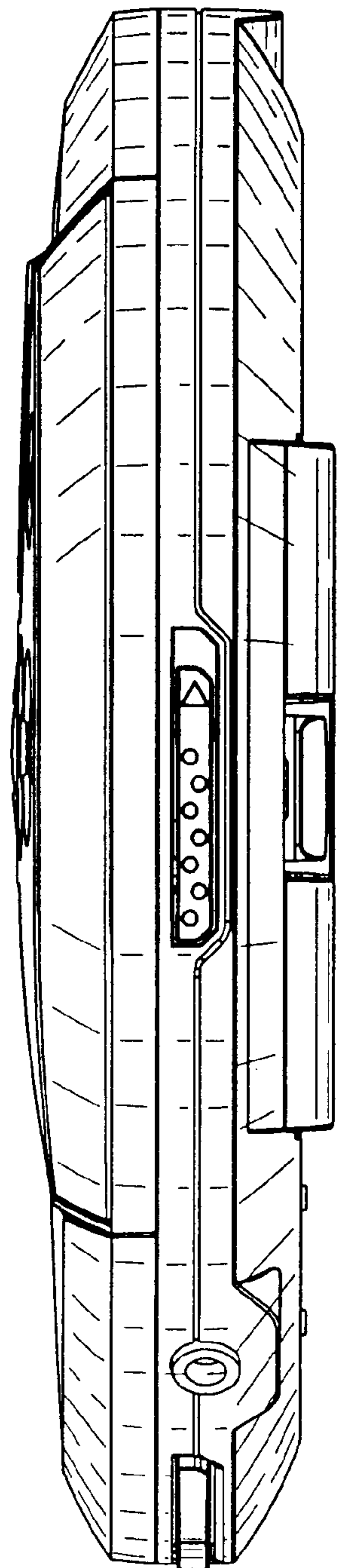

FIG. 5

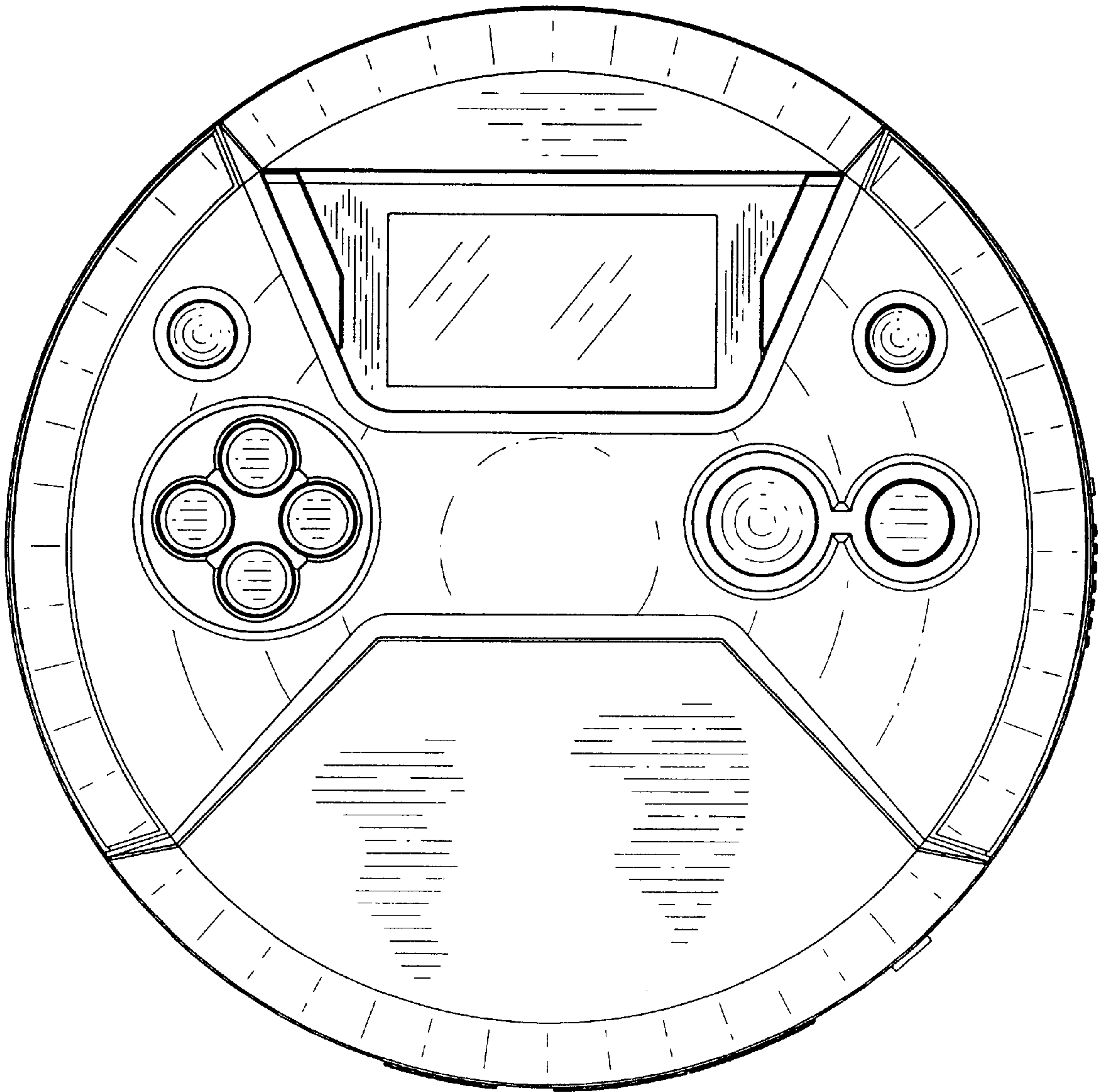

FIG. 6

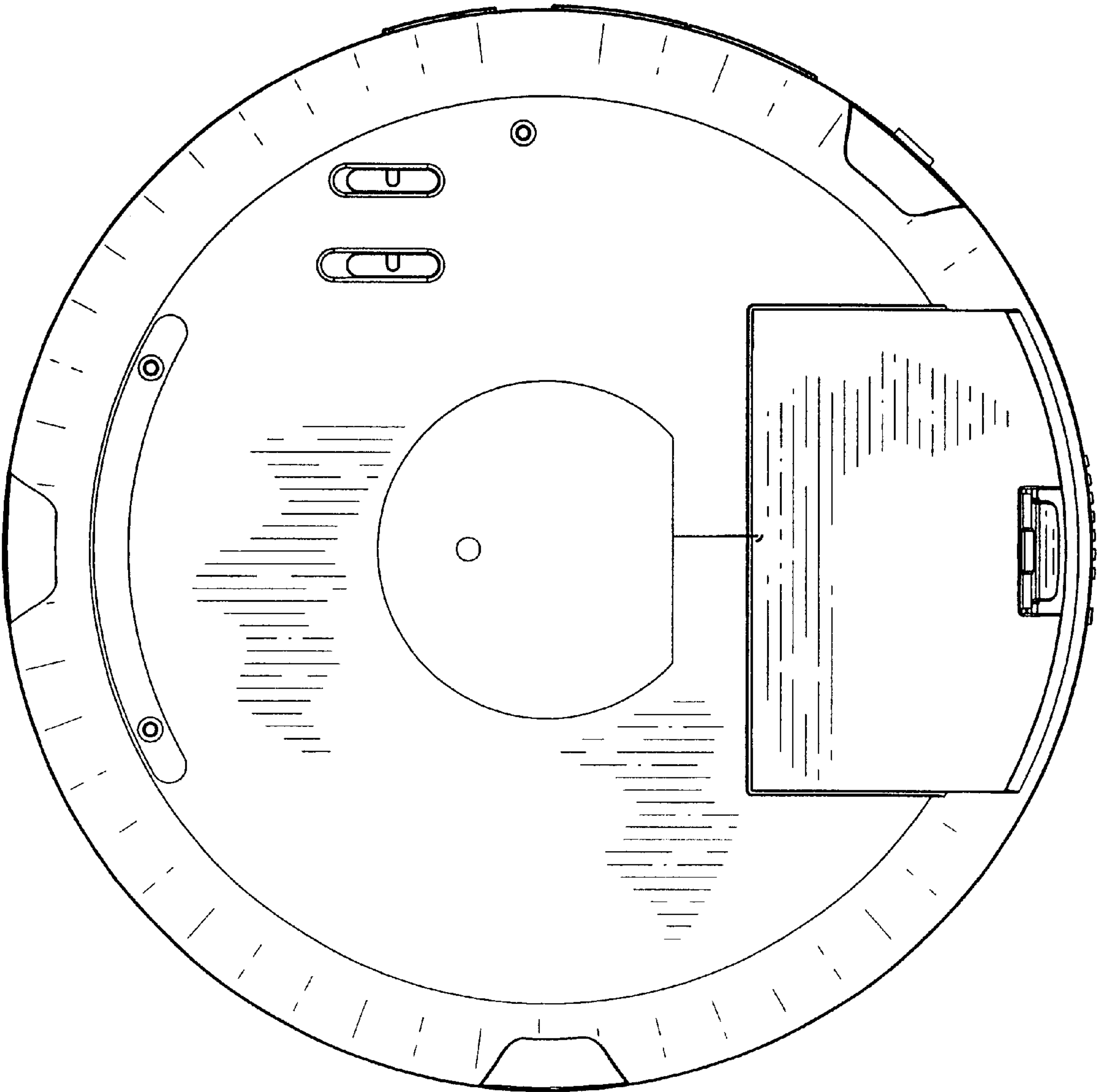

FIG. 7