



US00D478819S

(12) **United States Design Patent**  
**Pfaeffli et al.**

(10) **Patent No.:** **US D478,819 S**

(45) **Date of Patent:** **\*\* Aug. 26, 2003**

(54) **CONTAINER**

(75) Inventors: **Kurt Pfaeffli**, Hilterfingen (CH); **Marco Ackermann**, Conches (CH);  
**Jean-Jacques Zufferey**, Nyon (CH);  
**Christian Saclier**, Ambilly (FR)

(73) Assignee: **Novartis Nutrition AG**, Bern (CH)

(\*\*) Term: **14 Years**

(21) Appl. No.: **29/160,271**

(22) Filed: **May 8, 2002**

(30) **Foreign Application Priority Data**

Nov. 9, 2001 (CH) ..... 128353

(51) **LOC (7) Cl.** ..... **09-01**

(52) **U.S. Cl.** ..... **D9/559; D7/615; D7/607;**  
D9/571

(58) **Field of Search** ..... D7/612-615, 607;  
D9/500, 502-504, 516, 529, 559, 551, 564,  
571-575; 215/382-384, 396, 398, 400

(56) **References Cited**

**U.S. PATENT DOCUMENTS**

- 70,613 A \* 11/1867 Putnam ..... 222/565
- D85,067 S \* 9/1931 Sterrett ..... D9/561
- D140,495 S \* 3/1945 Bogoff ..... D28/82
- D210,865 S \* 4/1968 Skolnik ..... D9/337
- D336,824 S \* 6/1993 Ancona et al. .... D7/596
- D345,695 S \* 4/1994 Frazer et al. .... D9/500
- D351,348 S \* 10/1994 Marriage ..... D9/551
- 5,489,036 A \* 2/1996 Arkins ..... 215/384 X
- D387,278 S \* 12/1997 Olivares et al. .... D9/541
- 5,866,419 A \* 2/1999 Meder ..... 435/394

- 5,931,323 A \* 8/1999 Wilkinson et al. .... 215/383 X
- D425,423 S \* 5/2000 Mengeu et al. .... D9/503
- D456,265 S \* 4/2002 Spear ..... D9/502
- D463,982 S \* 10/2002 Speelman ..... D9/539
- D468,209 S \* 1/2003 Joubert ..... D9/529

\* cited by examiner

*Primary Examiner*—Ted Shooman

*Assistant Examiner*—Carol Rademaker

(74) *Attorney, Agent, or Firm*—John W. Kung

(57) **CLAIM**

The ornamental design for a container, as shown and described.

**DESCRIPTION**

FIG. 1 is a front view of the container of our new design, shown without the lid for ease of illustration;  
 FIG. 2 is a side view thereof;  
 FIG. 3 is a top view thereof;  
 FIG. 4 is a bottom view thereof;  
 FIG. 5 is a front perspective view thereof;  
 FIG. 6 is a front view of the container of FIG. 1, shown with the lid;  
 FIG. 7 is a side view thereof;  
 FIG. 8 is a top view thereof;  
 FIG. 9 is a bottom view thereof;  
 FIG. 10 is a front perspective thereof;  
 FIG. 11 is a perspective view taken from above of the easy-to-grip lid, shown separately for ease of illustration;  
 FIG. 12 is a perspective view taken from below thereof;  
 FIG. 13 is a top view thereof;  
 FIG. 14 is a bottom view thereof; and,  
 FIG. 15 is a front view thereof.

**1 Claim, 5 Drawing Sheets**

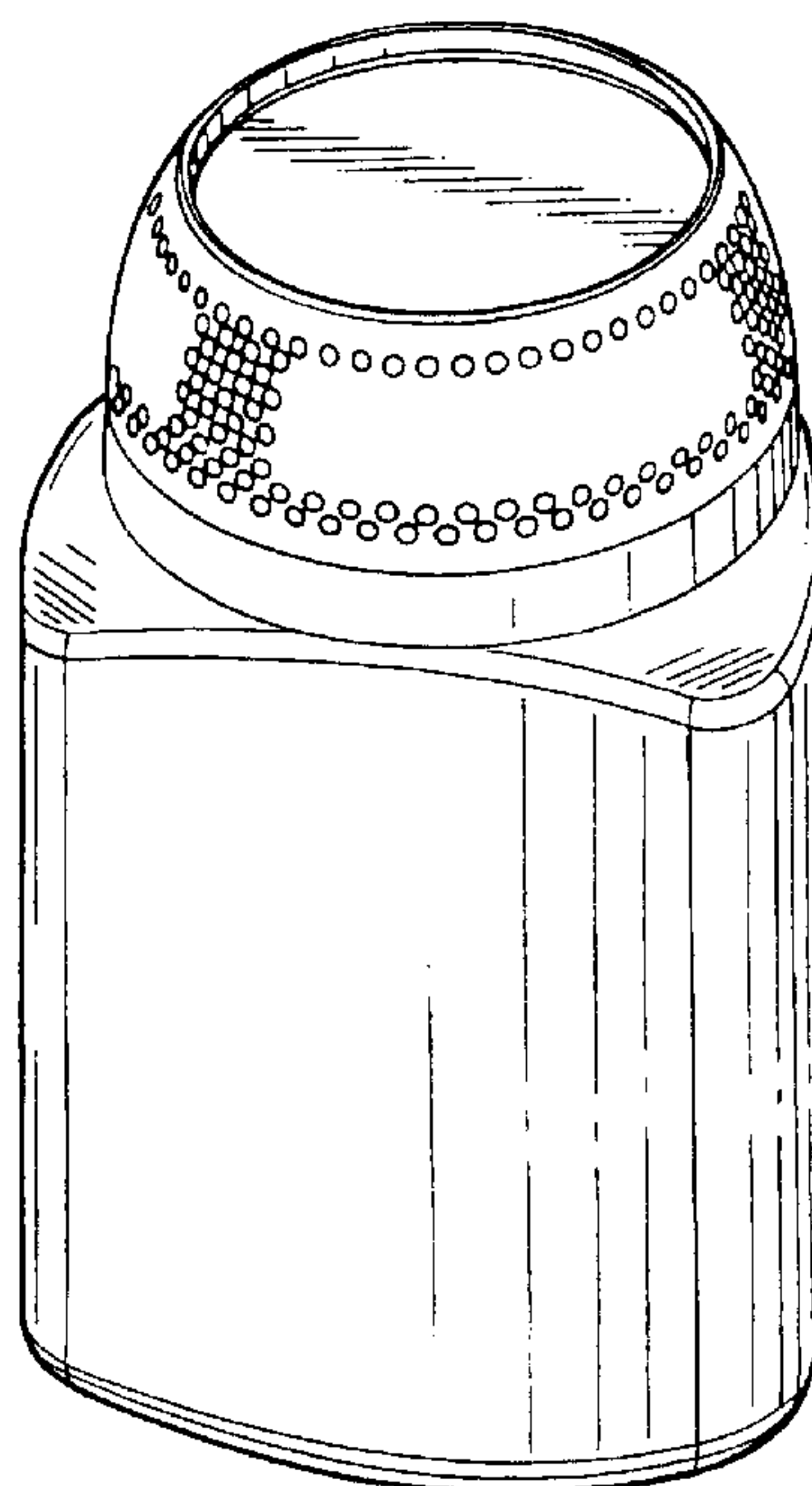
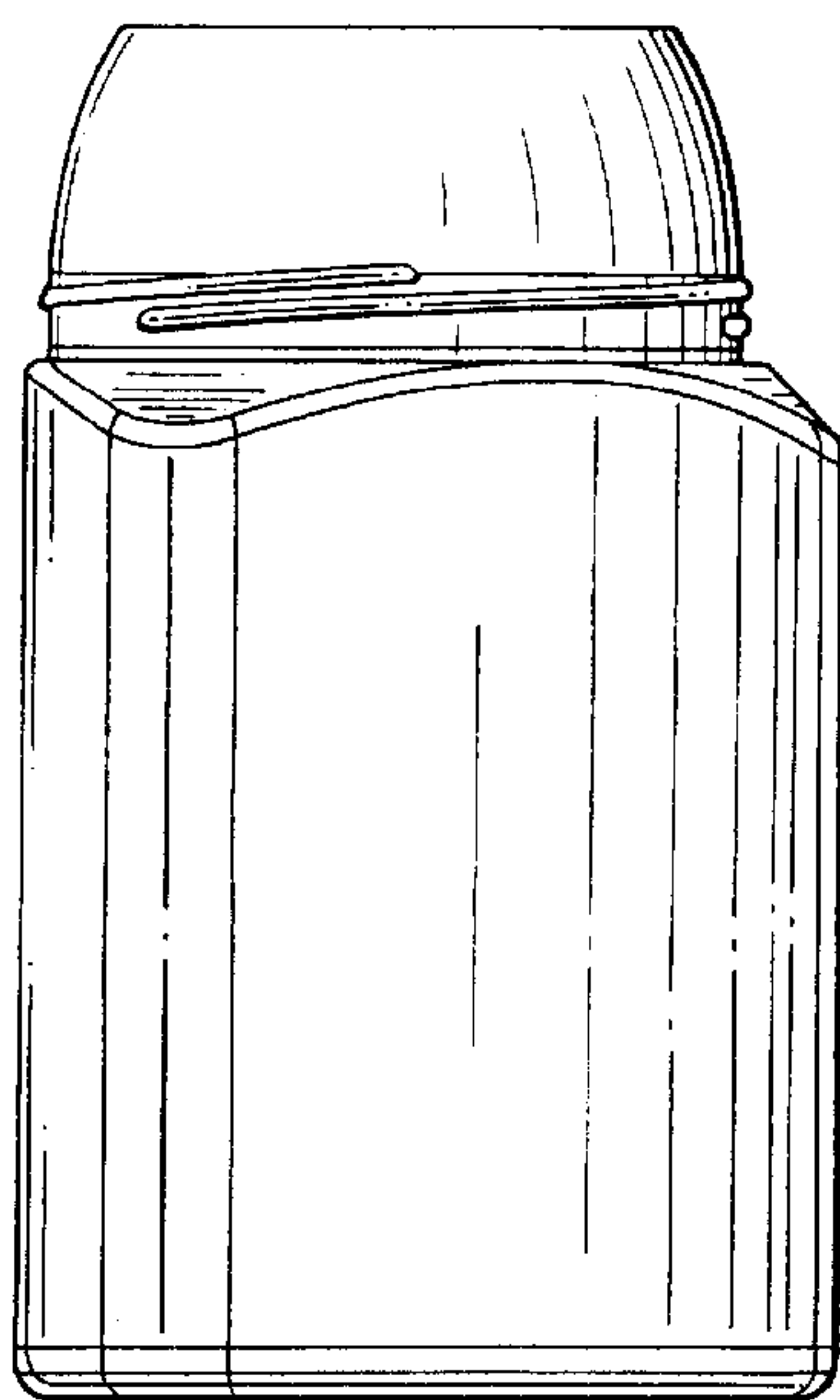

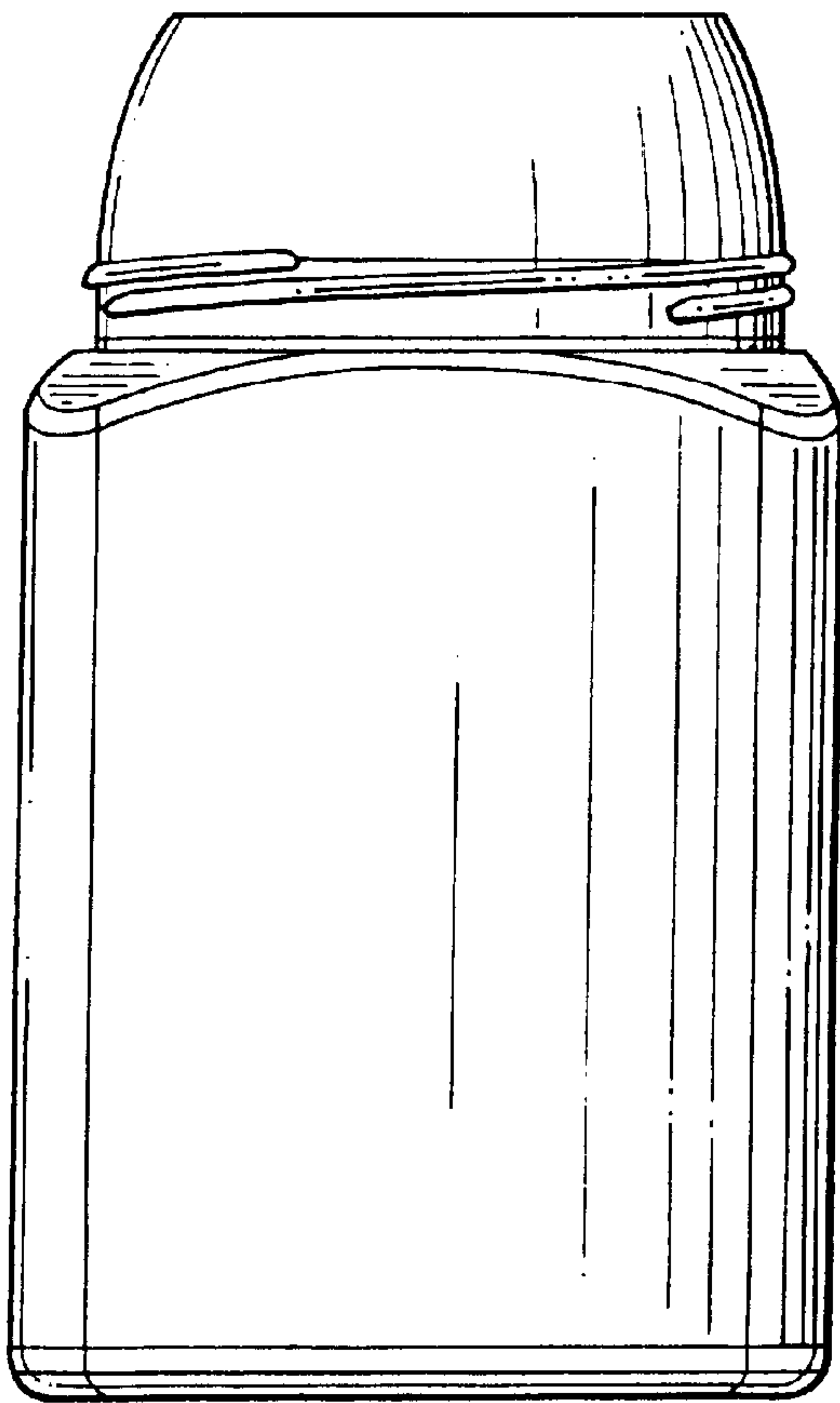

FIG. 1

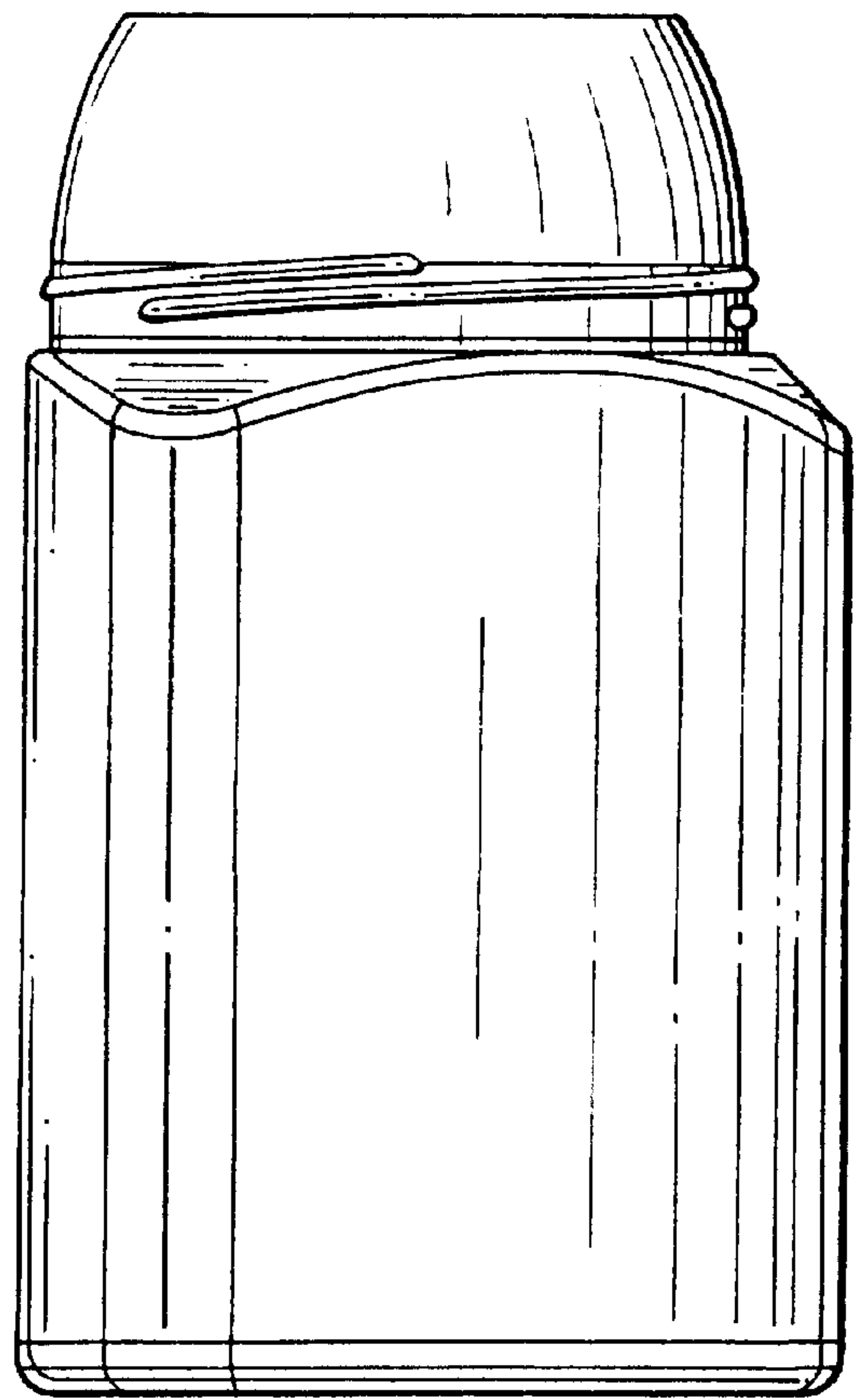

FIG. 2

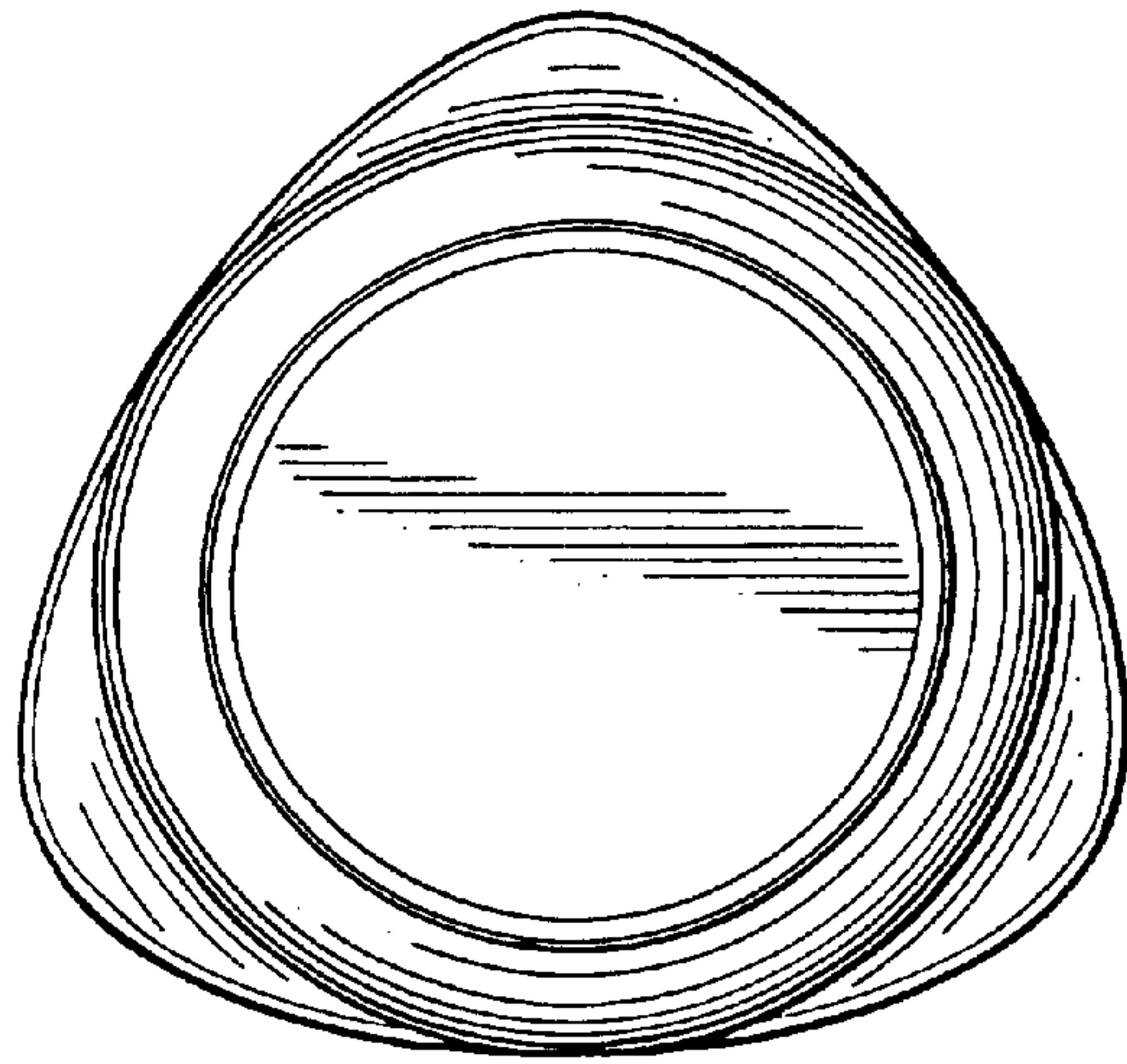

FIG. 3

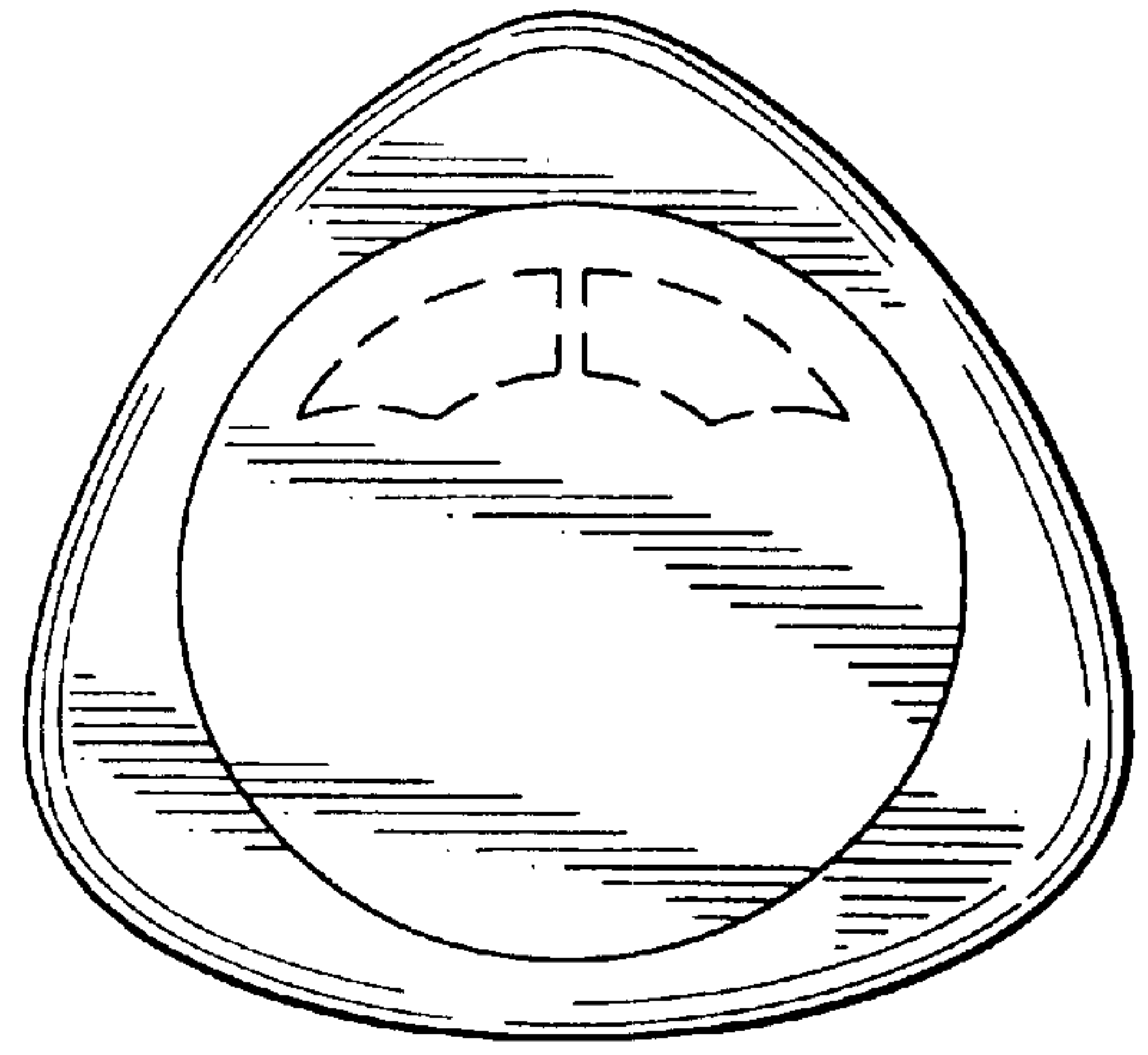

FIG. 4

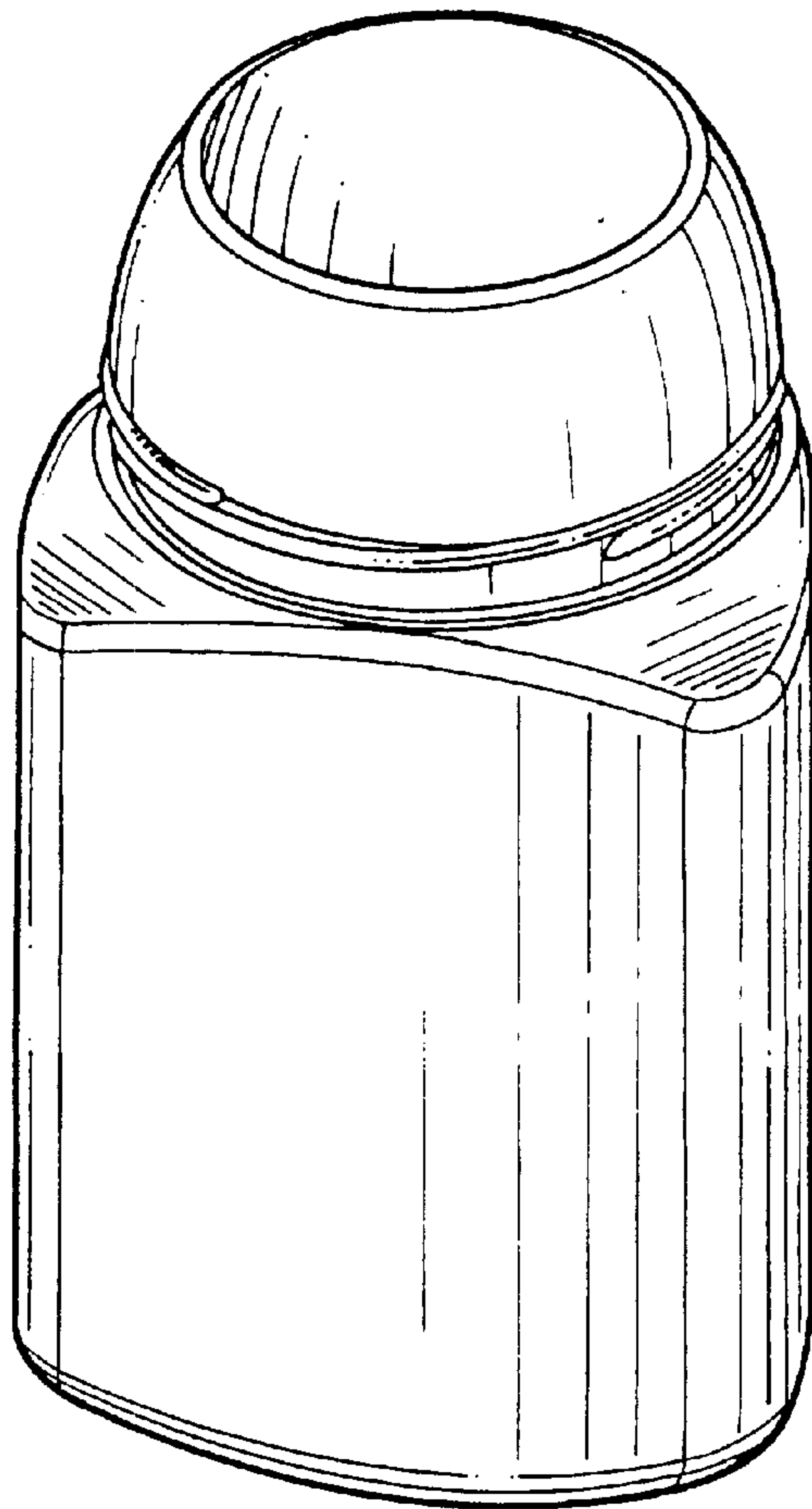

FIG. 5

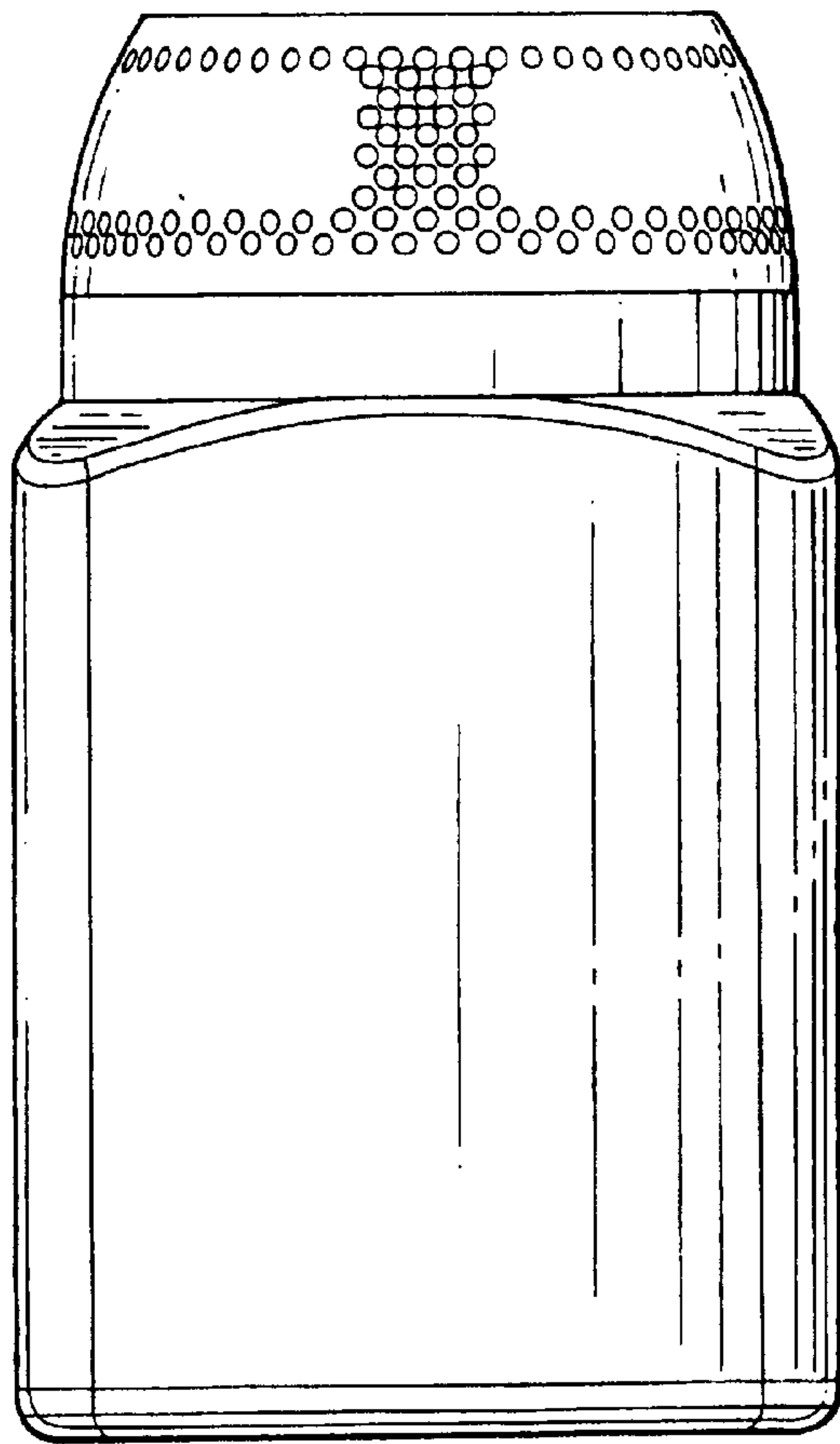

FIG. 6

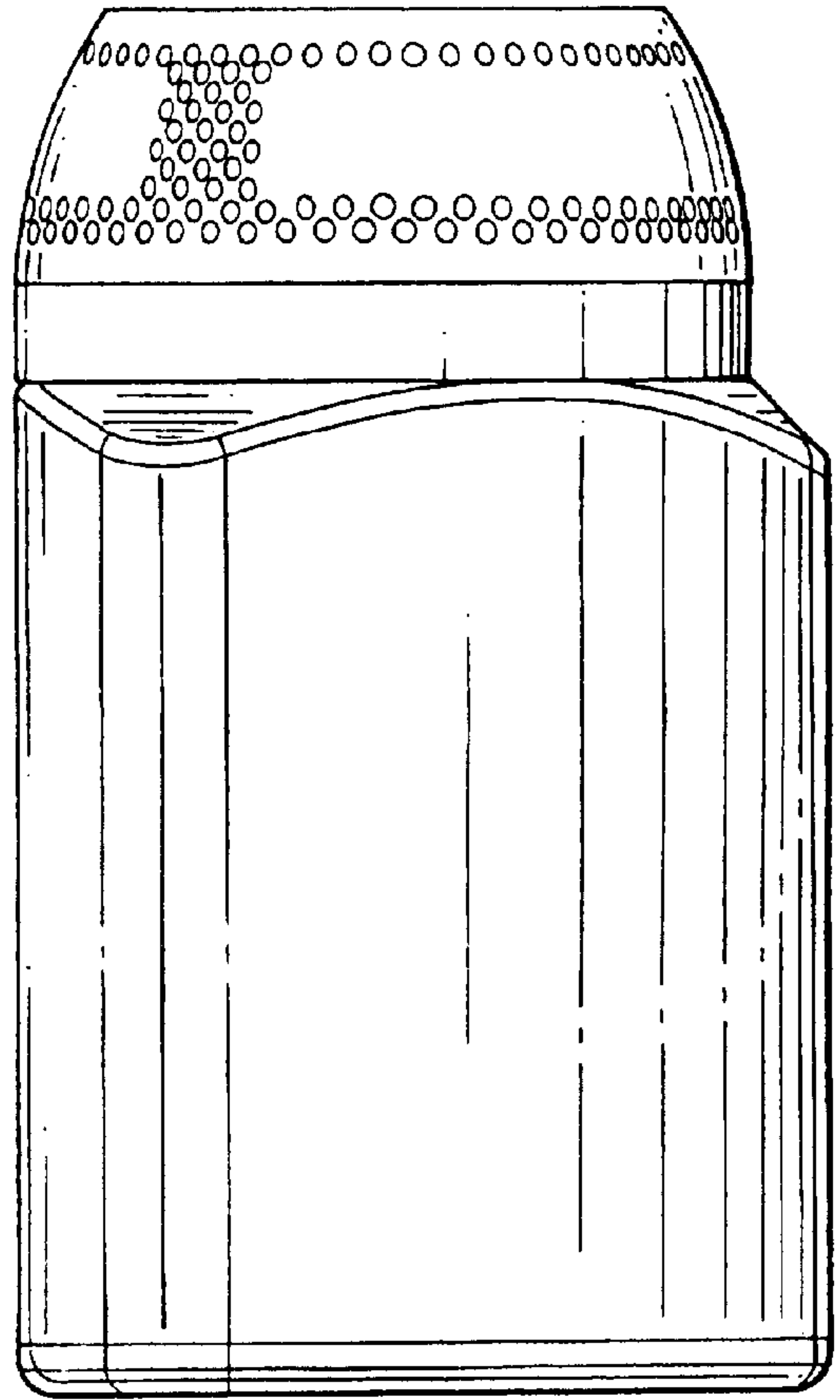

FIG. 7



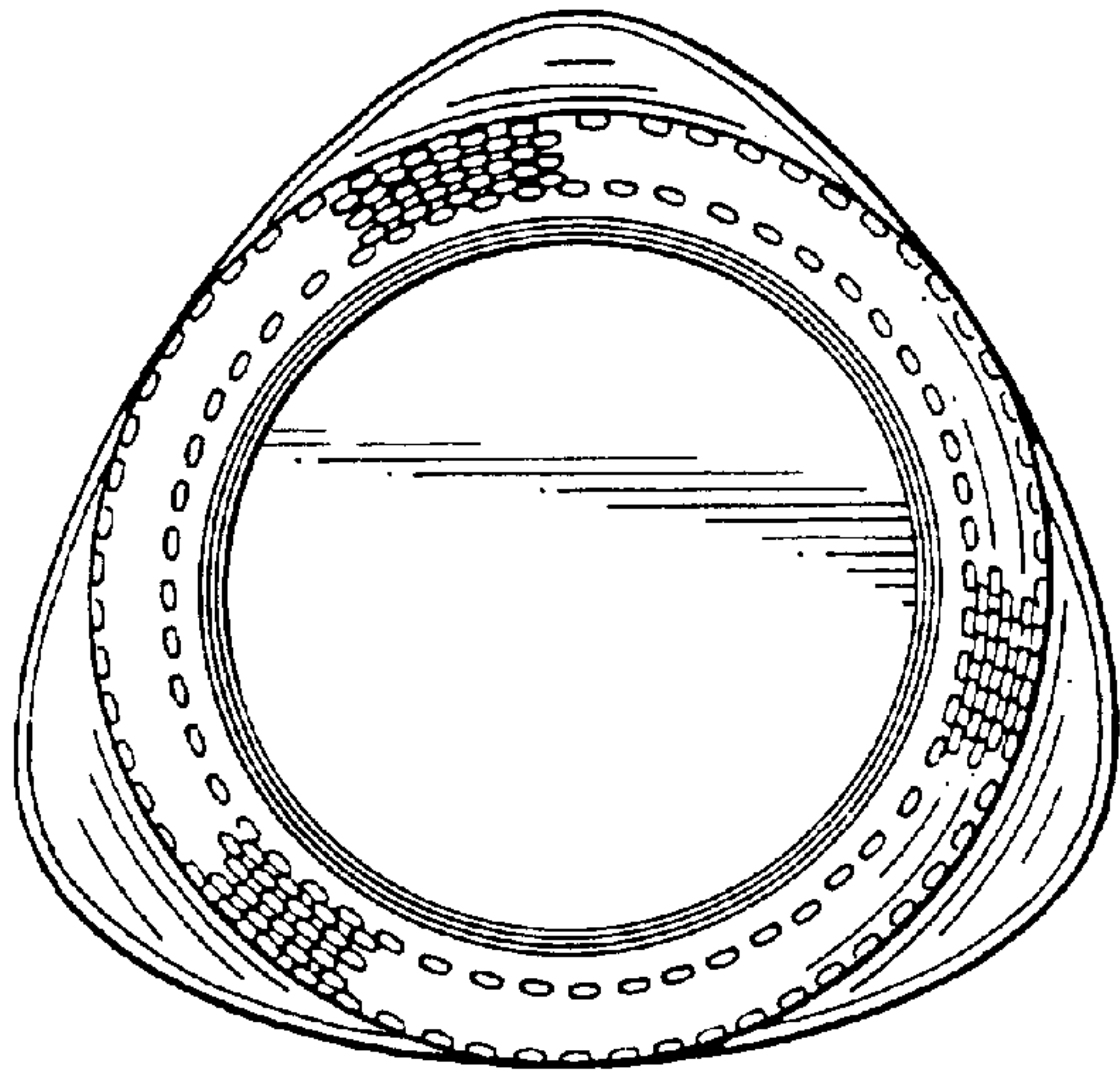

FIG. 8

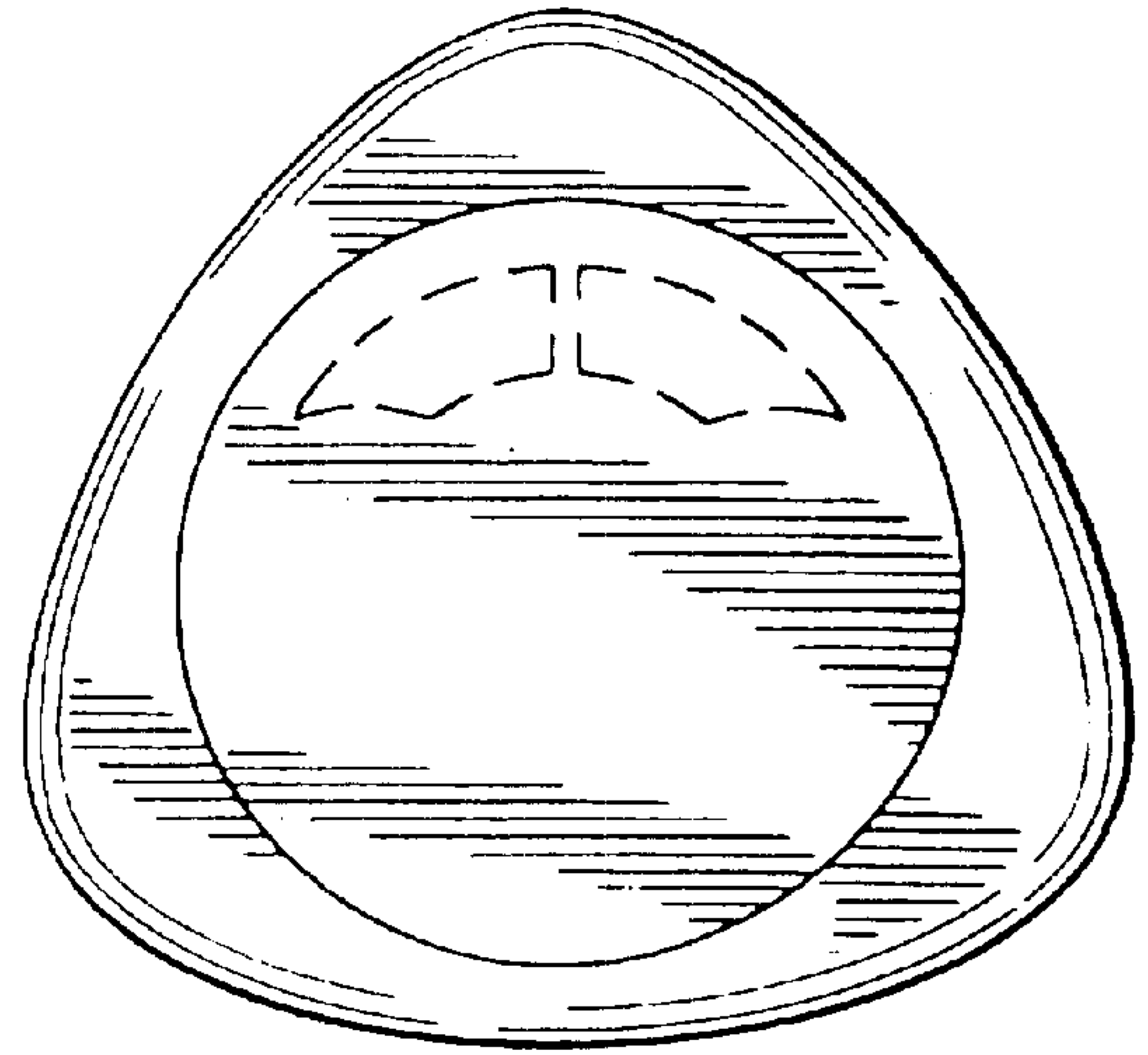

FIG. 9

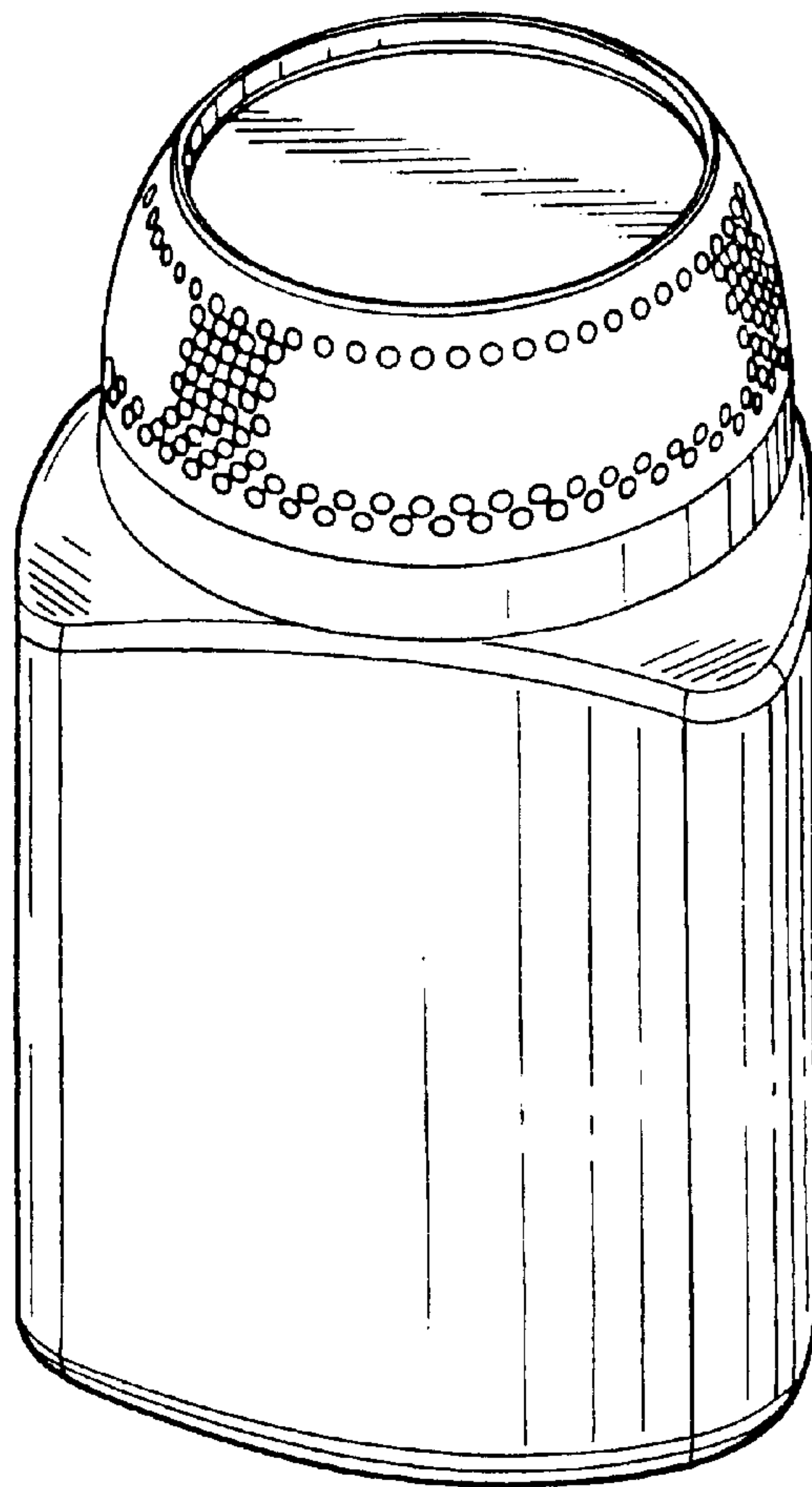

FIG. 10

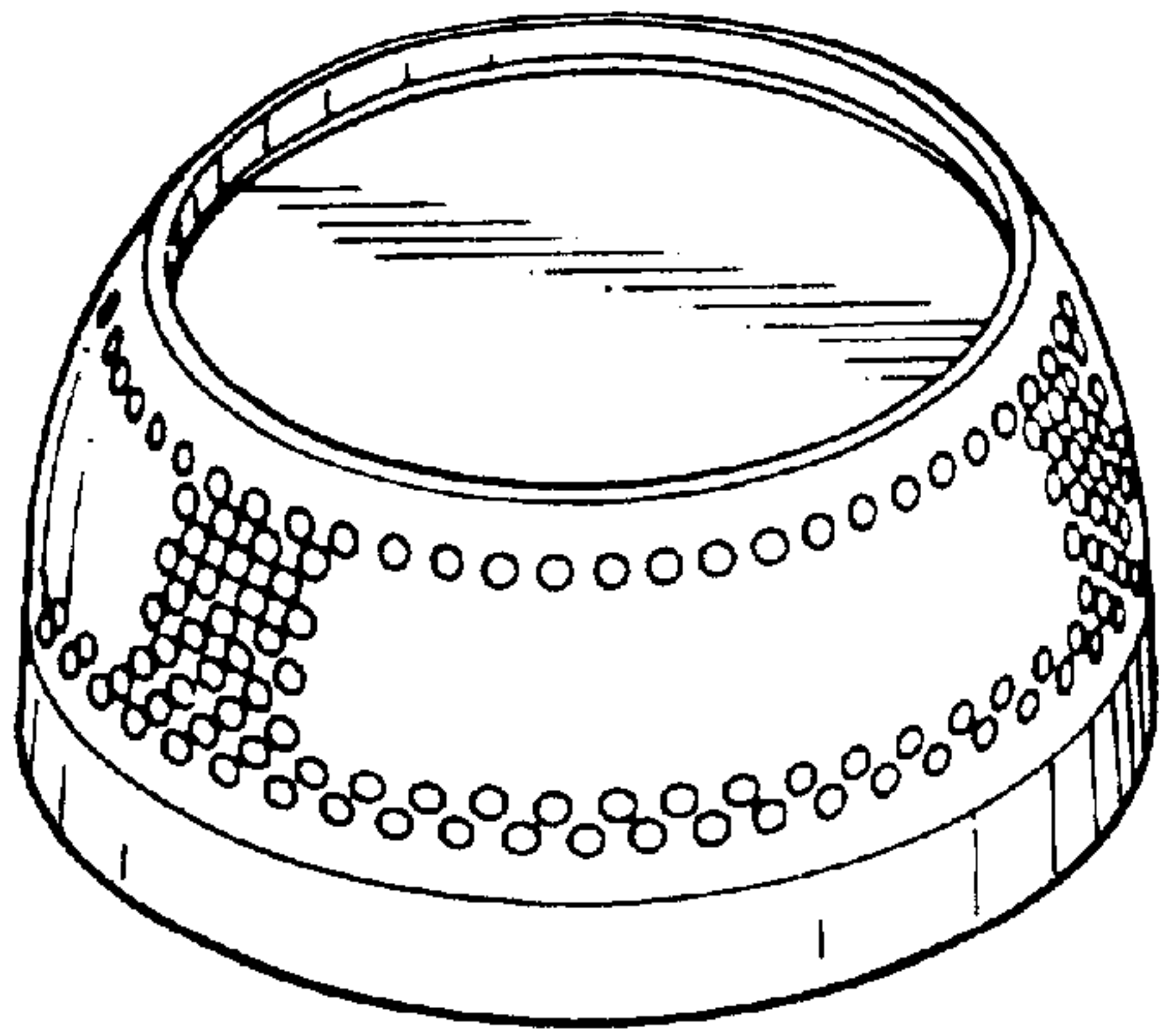

FIG. 11

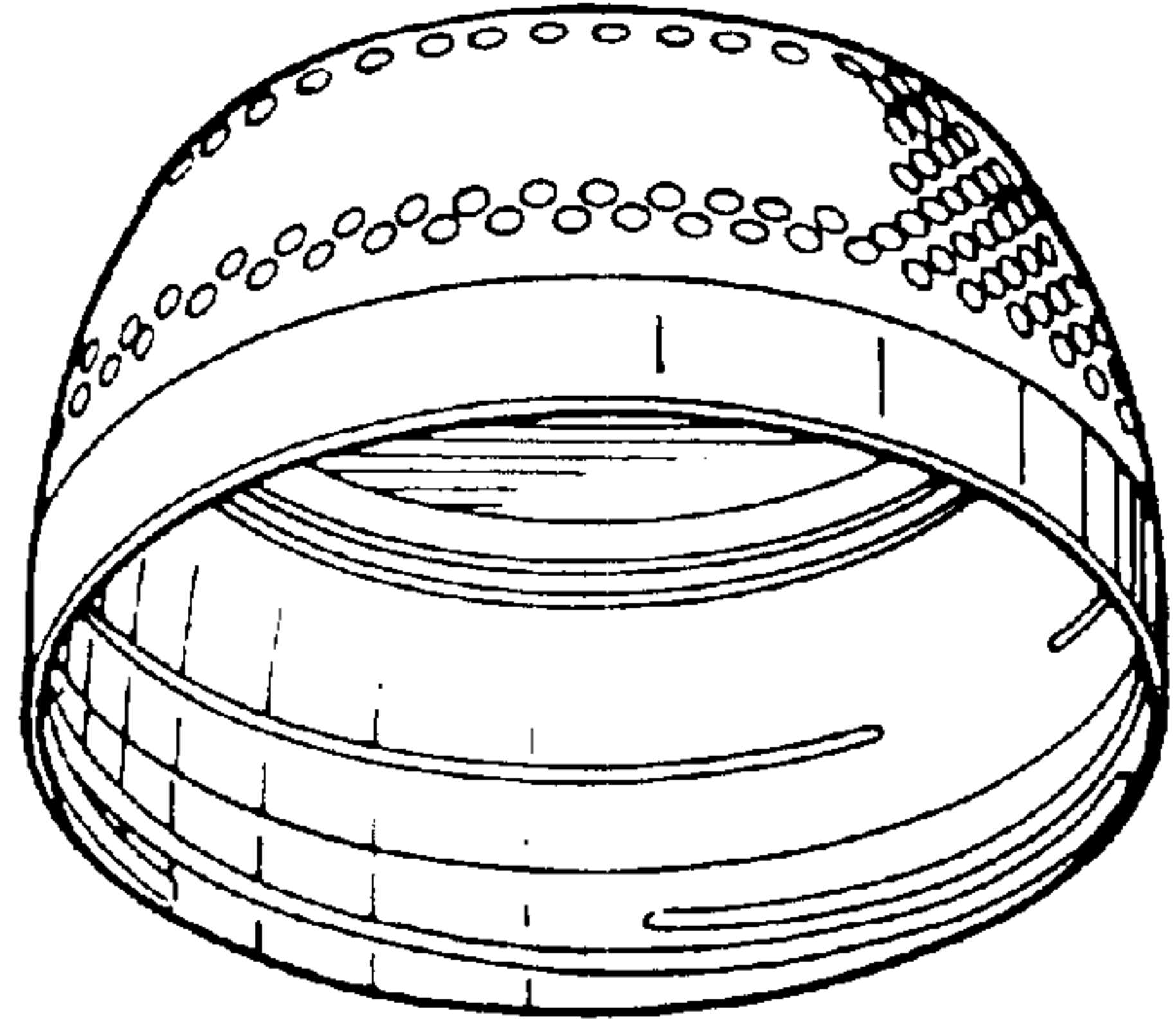

FIG. 12

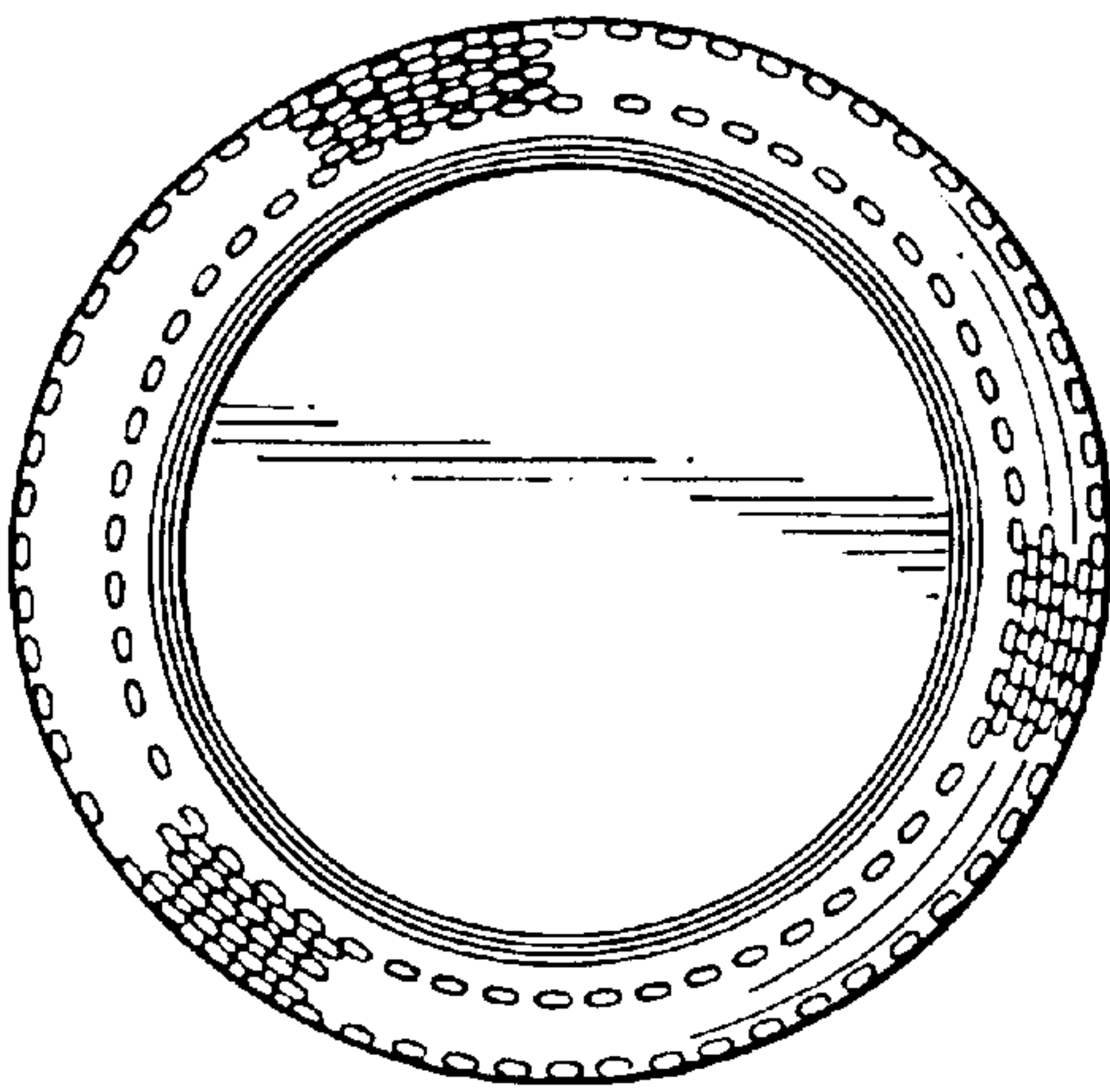

FIG. 13

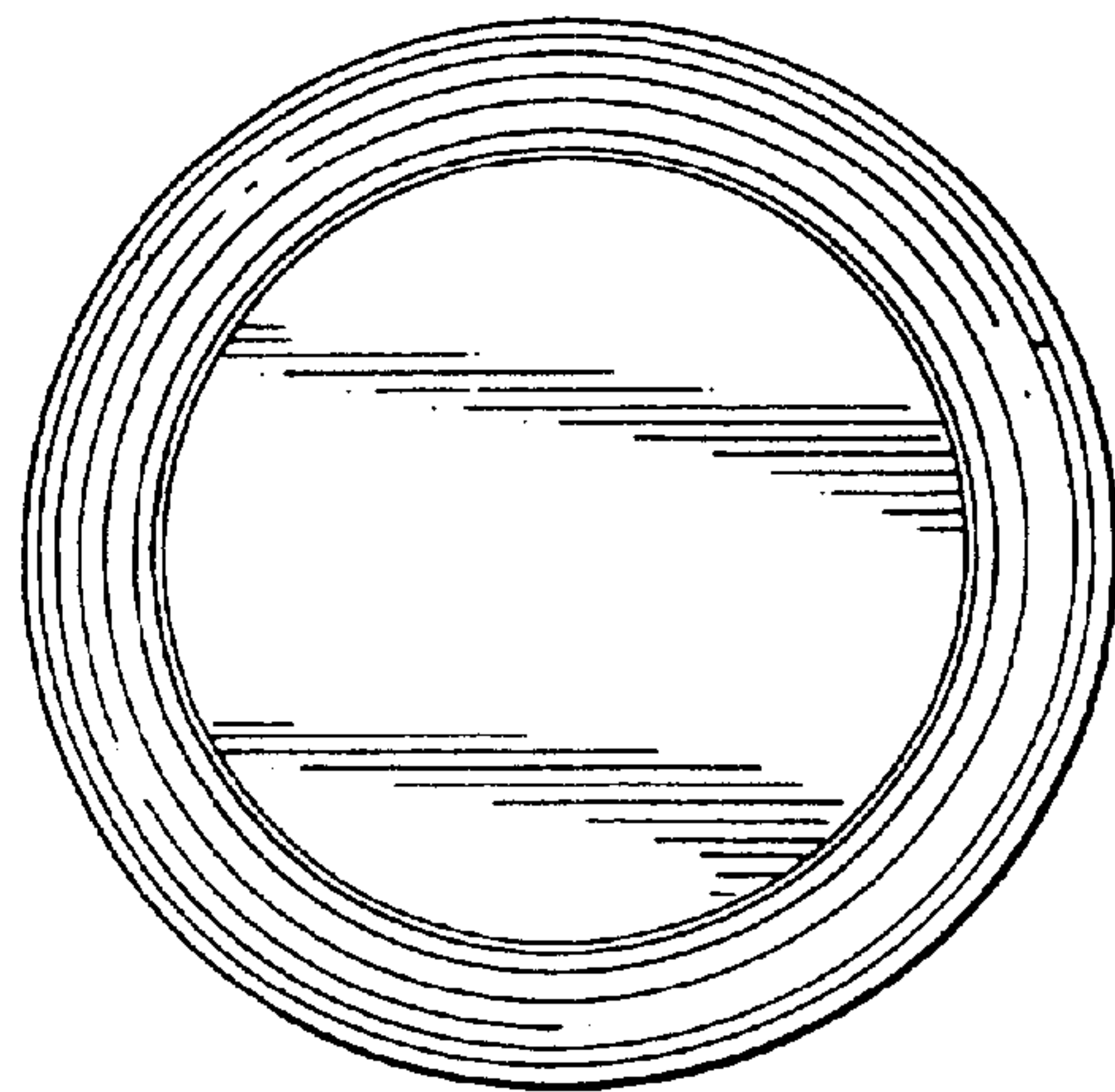

FIG. 14

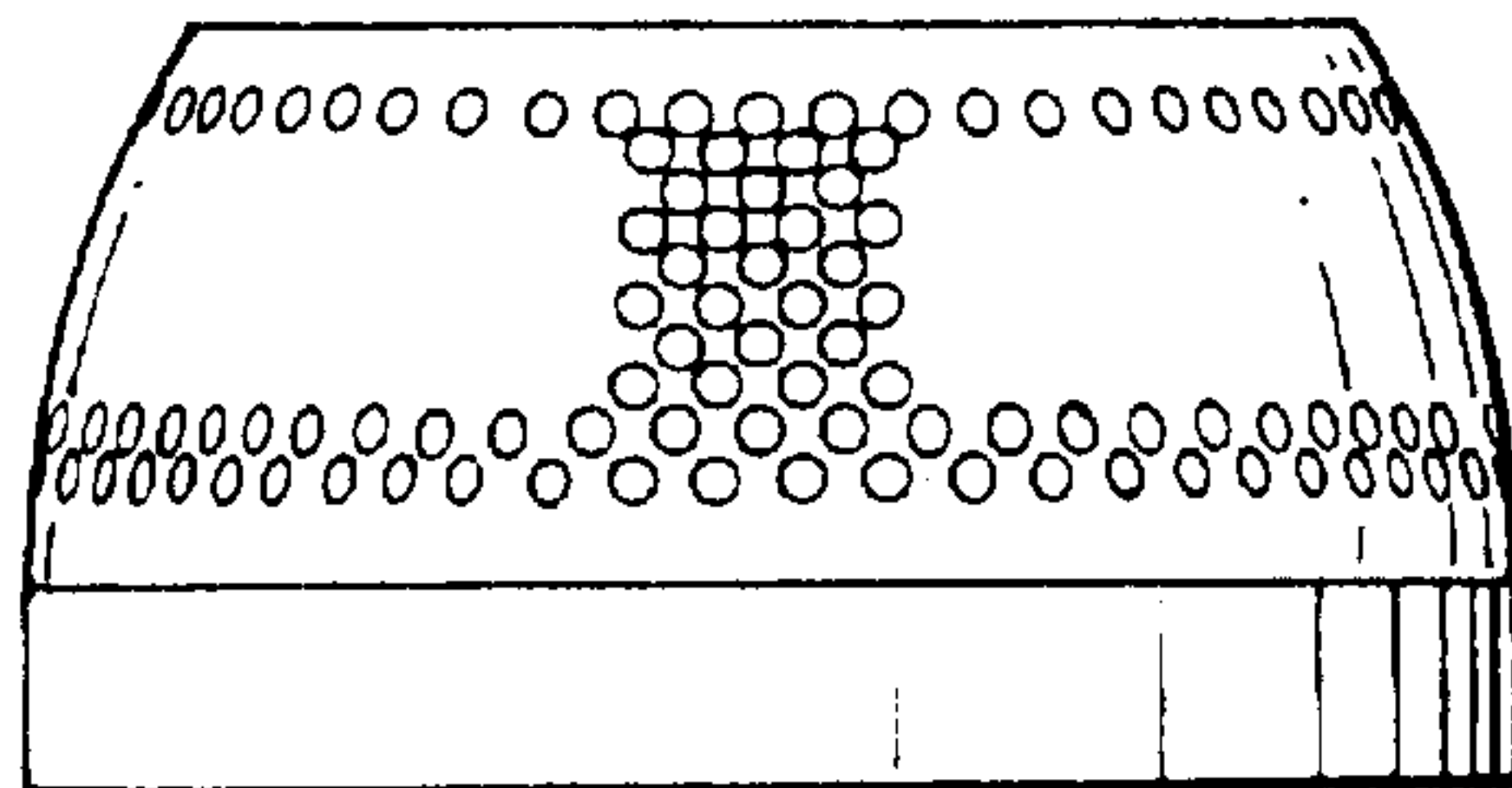

FIG. 15