



US00D478818S

(12) **United States Design Patent**
Barbagli

(10) **Patent No.:** **US D478,818 S**

(45) **Date of Patent:** **** Aug. 26, 2003**

(54) **CONTAINER**

(75) Inventor: **Costantino Barbagli**, Florence (IT)

(73) Assignee: **Drogheria E Alimentari S.r.l.**, Prato (IT)

(**) Term: **14 Years**

(21) Appl. No.: **29/133,584**

(22) Filed: **Dec. 1, 2000**

(30) **Foreign Application Priority Data**

Jun. 2, 2000 (WO) DMA/004928

(51) **LOC (7) Cl.** **09-01**

(52) **U.S. Cl.** **D9/551; D9/558; D9/564; D9/575**

(58) **Field of Search** D3/202; D6/542; D7/306; D9/338, 500, 502-504, 516, 521-523, 525-531, 537-540, 541-546, 549, 551, 556-558, 569, 570, 574-575; D24/121, 224; D32/25, 30, 45, 10; 215/12.1-12.3, 12.5, 382-384, 396, 398, 400

(56) **References Cited**

U.S. PATENT DOCUMENTS

D28,731 S * 5/1898 Bogert D9/502
D87,397 S * 7/1932 Marshburn et al. D9/571
D107,433 S * 12/1937 Lorenzen D9/550
D213,541 S * 3/1969 Cowan D9/529
D236,689 S * 9/1975 Weekman D9/558

D274,886 S * 7/1984 Capezzuto D9/504
D281,399 S * 11/1985 Fortuna D9/500
D285,776 S * 9/1986 Kretz D9/558
D328,423 S * 8/1992 DeGaetano D9/556
D367,614 S * 3/1996 Pagarani D9/559
D376,319 S * 12/1996 Miller D9/538
D414,703 S * 10/1999 Nosella D9/563
D432,428 S 10/2000 Barbagli D9/545
D447,331 S * 9/2001 Martin et al. D3/201

* cited by examiner

Primary Examiner—Ted Shooman

Assistant Examiner—Carol Rademaker

(74) *Attorney, Agent, or Firm*—Sheridan Ross PC

(57) **CLAIM**

The ornamental design for a container, as shown and described.

DESCRIPTION

FIG. 1 is a front elevation view of a container, showing my new design;
FIG. 2 is a right elevation view of the container shown in FIG. 1;
FIG. 3 is a rear elevation view of the container shown in FIG. 1;
FIG. 4 is a top plan view of the container shown in FIG. 1;
FIG. 5 is a bottom plan view of the container shown in FIG. 1; and,
FIG. 6 is a front/side perspective view of the container shown in FIG. 1.

1 Claim, 3 Drawing Sheets

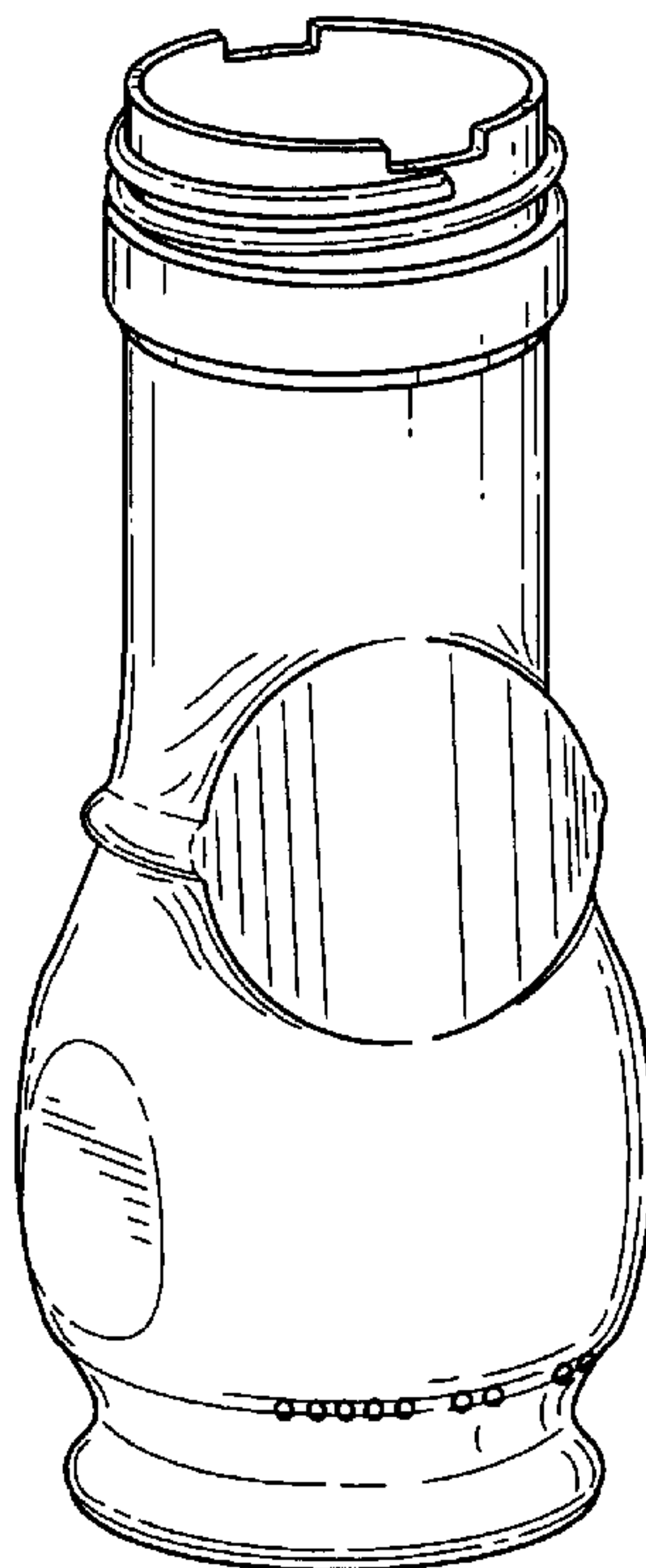

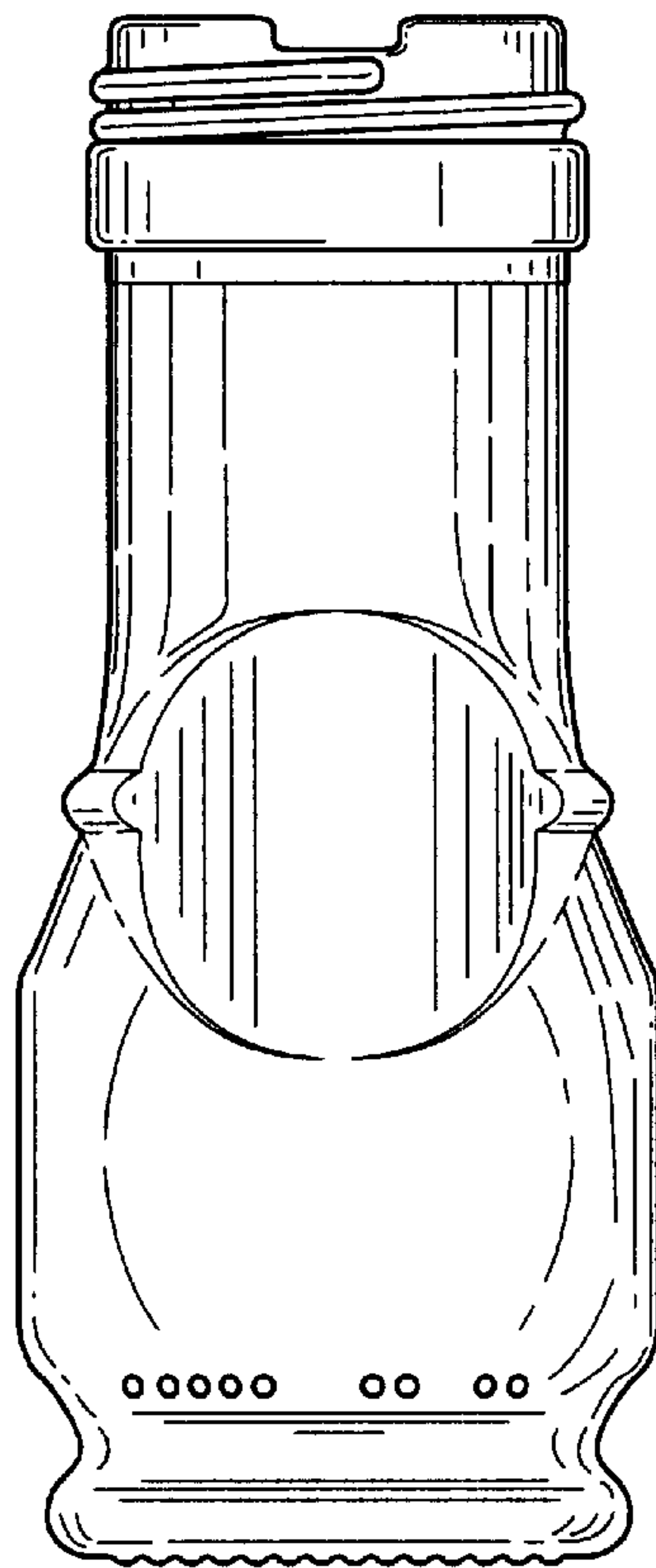

FIG.1

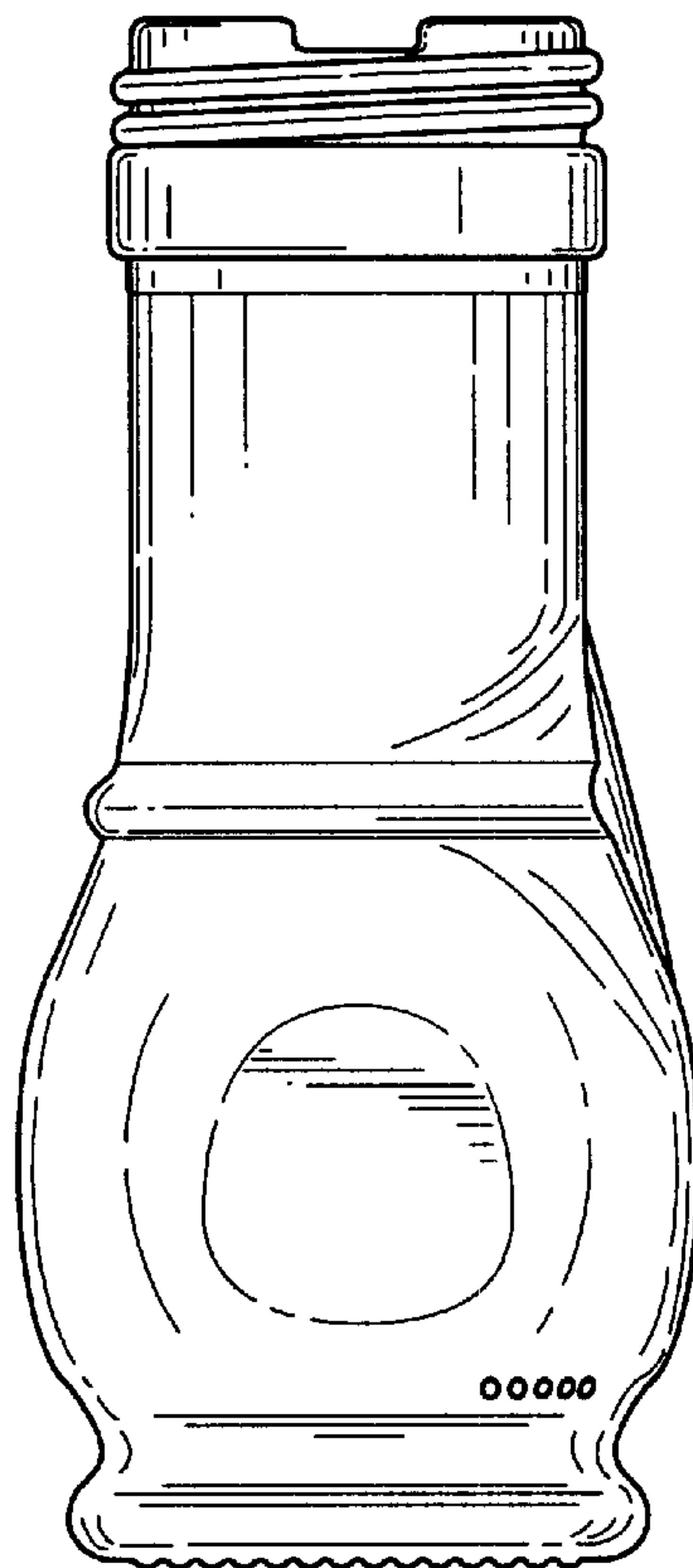

FIG.2

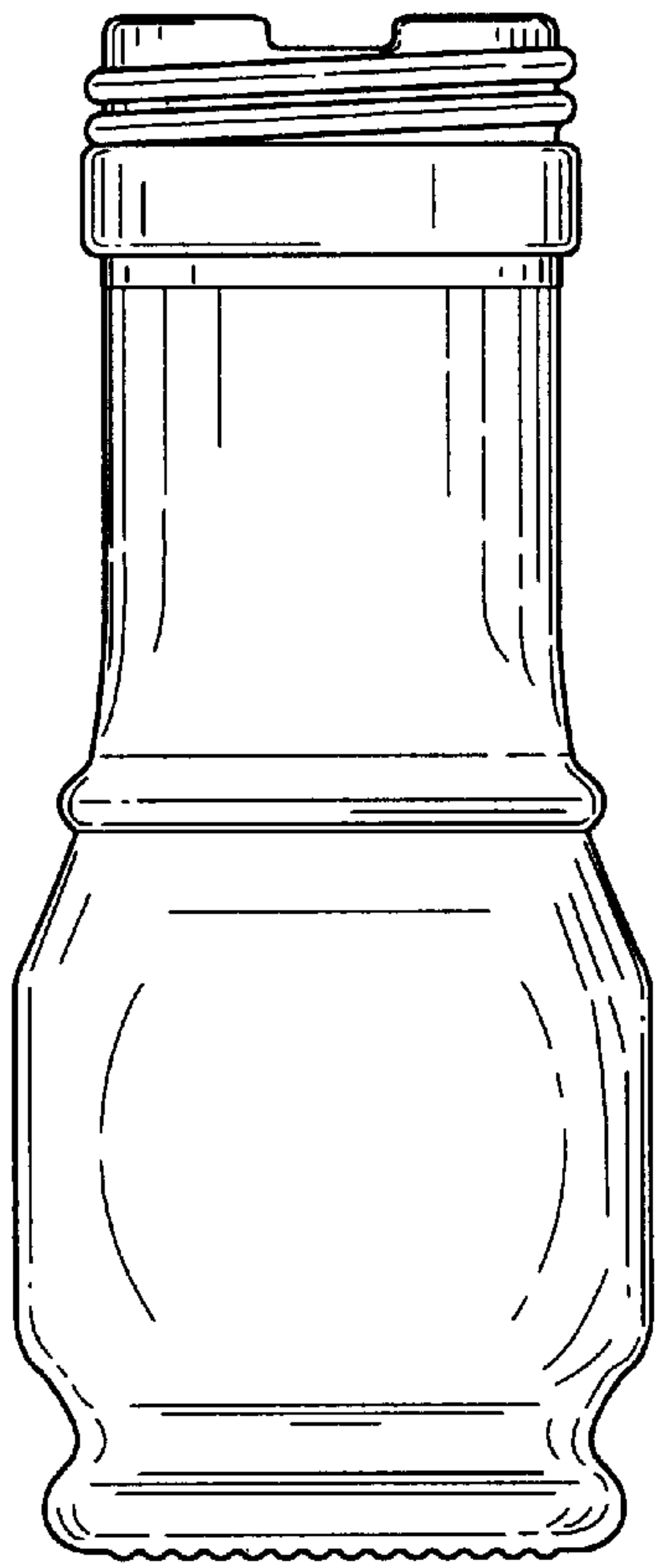

FIG.3

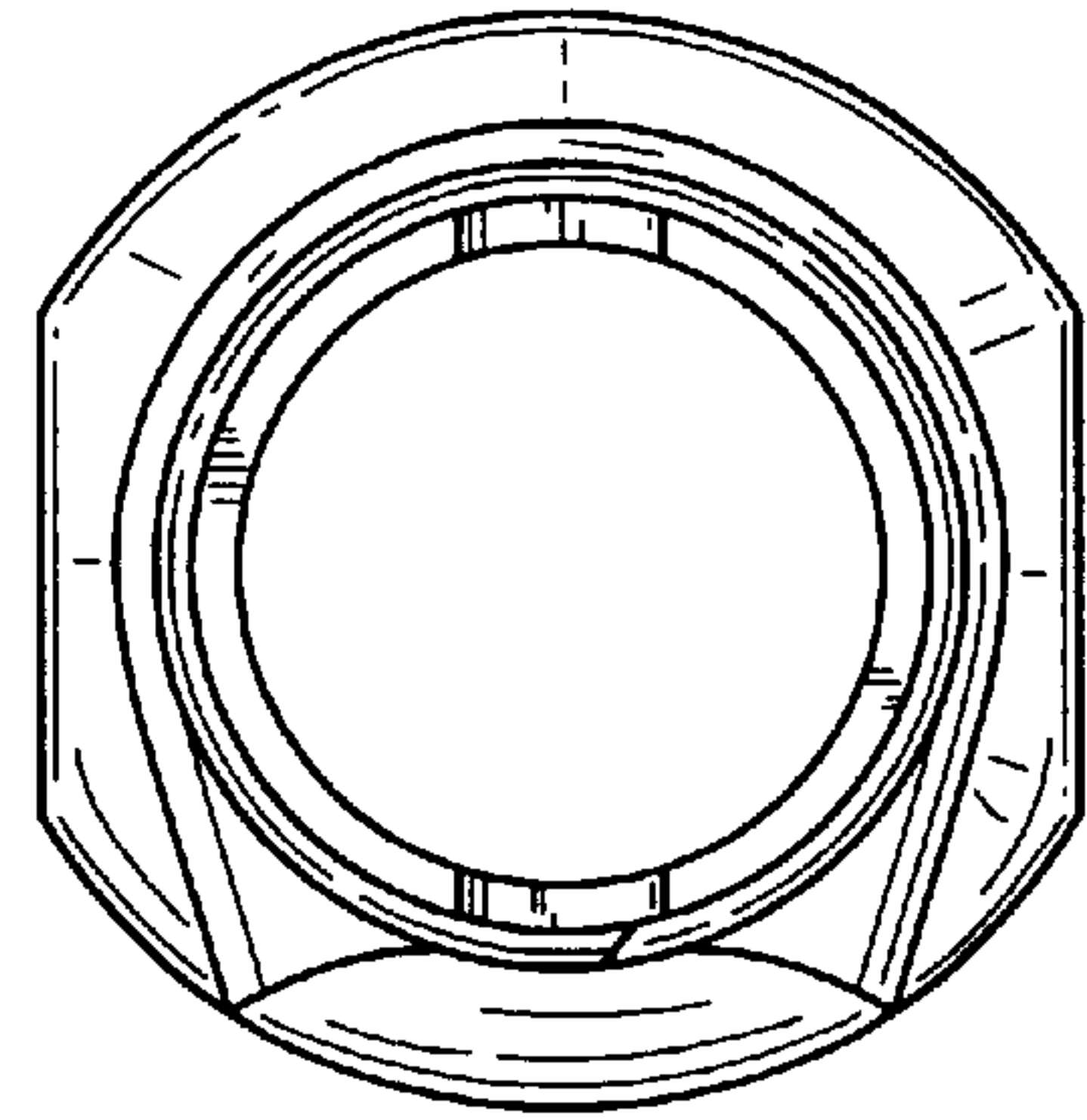

FIG.4

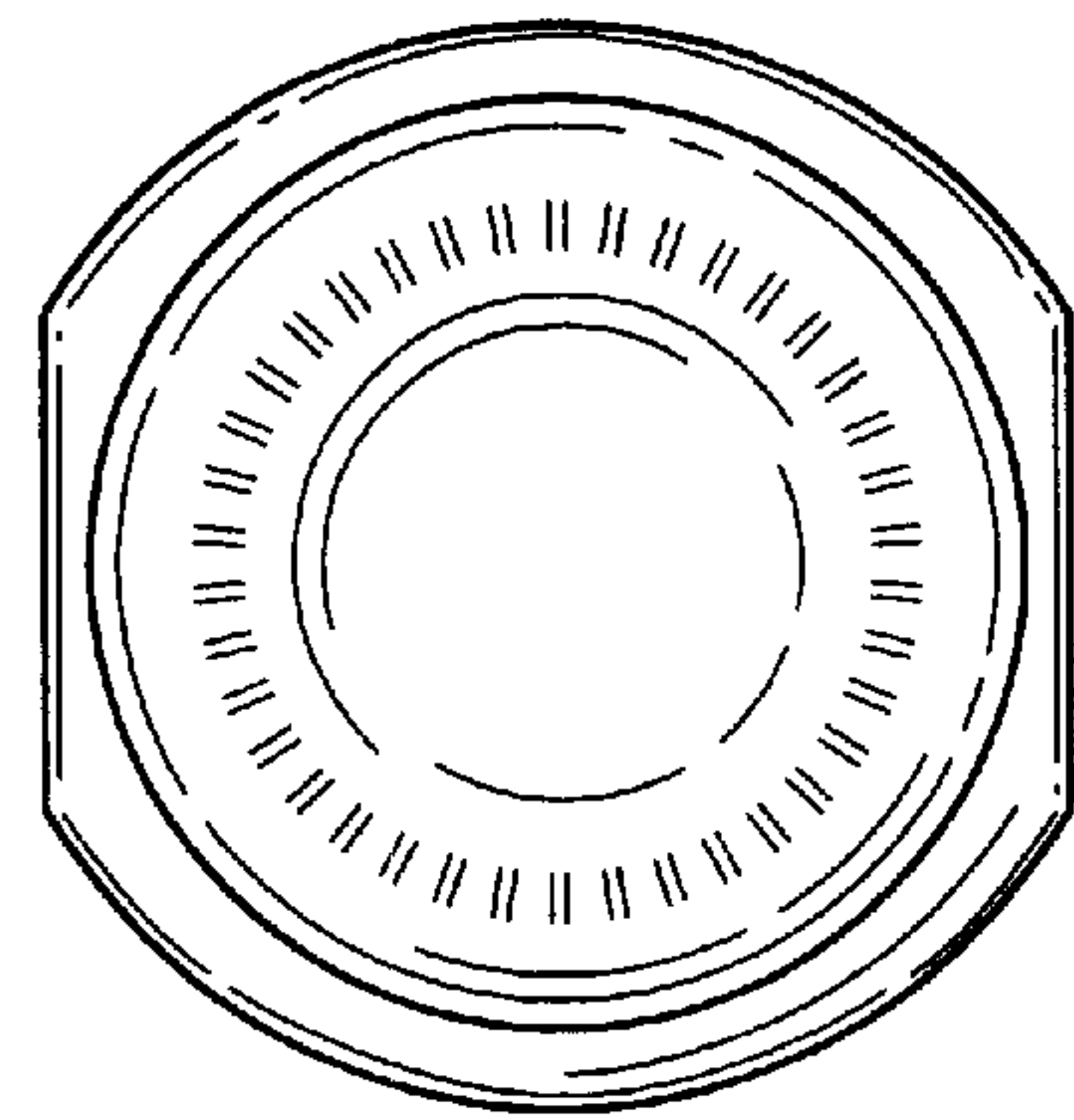

FIG.5

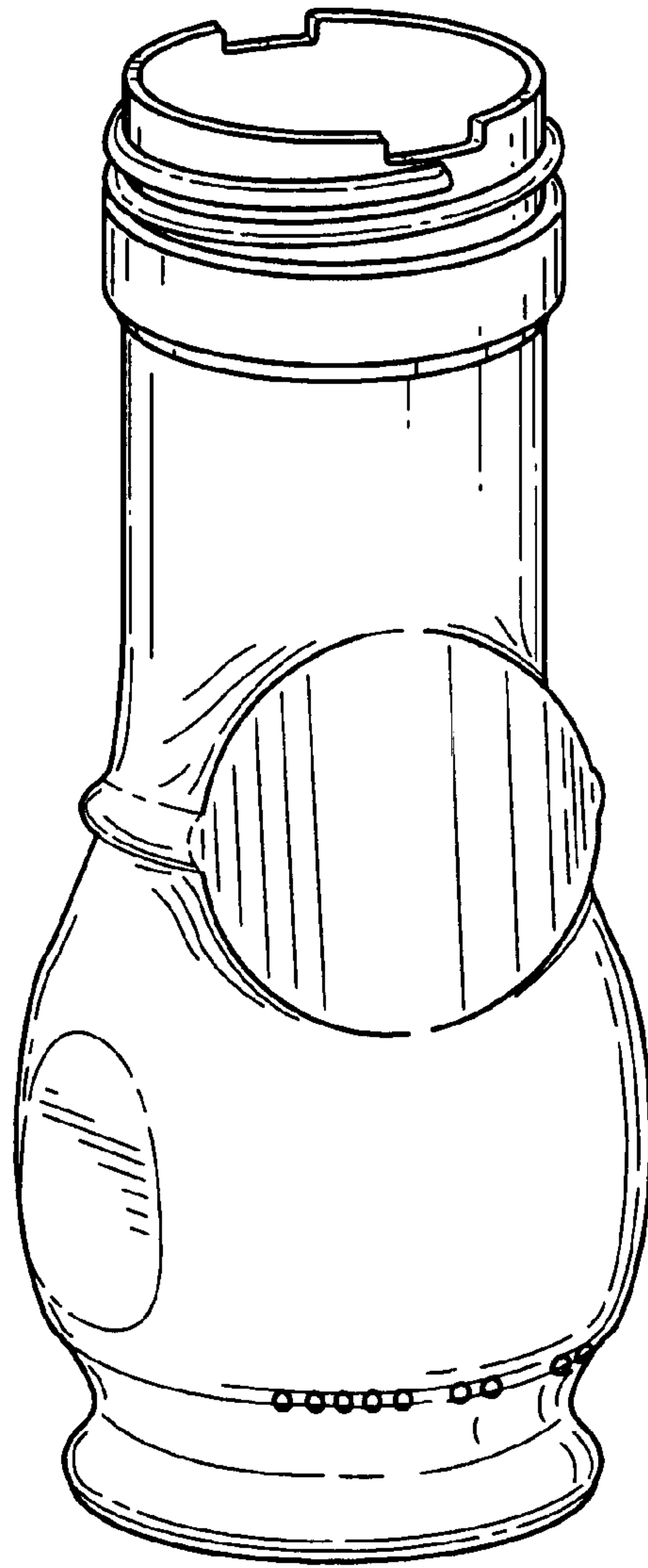

FIG. 6