



US00D478799S

(12) **United States Design Patent**  
**Chi Kuo**

(10) **Patent No.:** **US D478,799 S**

(45) **Date of Patent:** **\*\* Aug. 26, 2003**

(54) **STAPLER**

(76) **Inventor:** **Su-Chao Chi Kuo**, No. 68,  
Kuang-Cheng Rd., Tali City, Taichung  
Hsien (TW)

(\*\*) **Term:** **14 Years**

(21) **Appl. No.:** **29/174,843**

(22) **Filed:** **Jan. 24, 2003**

(65) **Prior Publication Data**

(65)

(51) **LOC (7) Cl.** ..... **19-02**

(52) **U.S. Cl.** ..... **D8/50; D19/72**

(58) **Field of Search** ..... **D8/49, 50; D19/72;**  
**227/120, 127, 128, 131, 132, 134, 156**

(56) **References Cited**

**U.S. PATENT DOCUMENTS**

5,690,268 A \* 11/1997 Evans et al. .... 227/156  
D392,528 S \* 3/1998 Rossetto et al. .... D8/50

D414,999 S \* 10/1999 Wilson et al. .... D8/50  
D457,794 S \* 5/2002 Jacquet ..... D8/50  
D465,139 S \* 11/2002 Robillard ..... D8/50  
D470,024 S \* 2/2003 Robillard ..... D8/50

\* cited by examiner

*Primary Examiner*—Adir Aronovich  
(74) *Attorney, Agent, or Firm*—Dellett and Walters

(57) **CLAIM**

The ornamental design for a stapler, as shown.

**DESCRIPTION**

FIG. 1 is a perspective view of a stapler, showing my new design;  
FIG. 2 is a front elevational view thereof;  
FIG. 3 is a rear elevational view thereof;  
FIG. 4 is a left side elevational view thereof;  
FIG. 5 is a right side elevational view thereof;  
FIG. 6 is a top plan view thereof; and,  
FIG. 7 is a bottom plan view thereof.

**1 Claim, 4 Drawing Sheets**

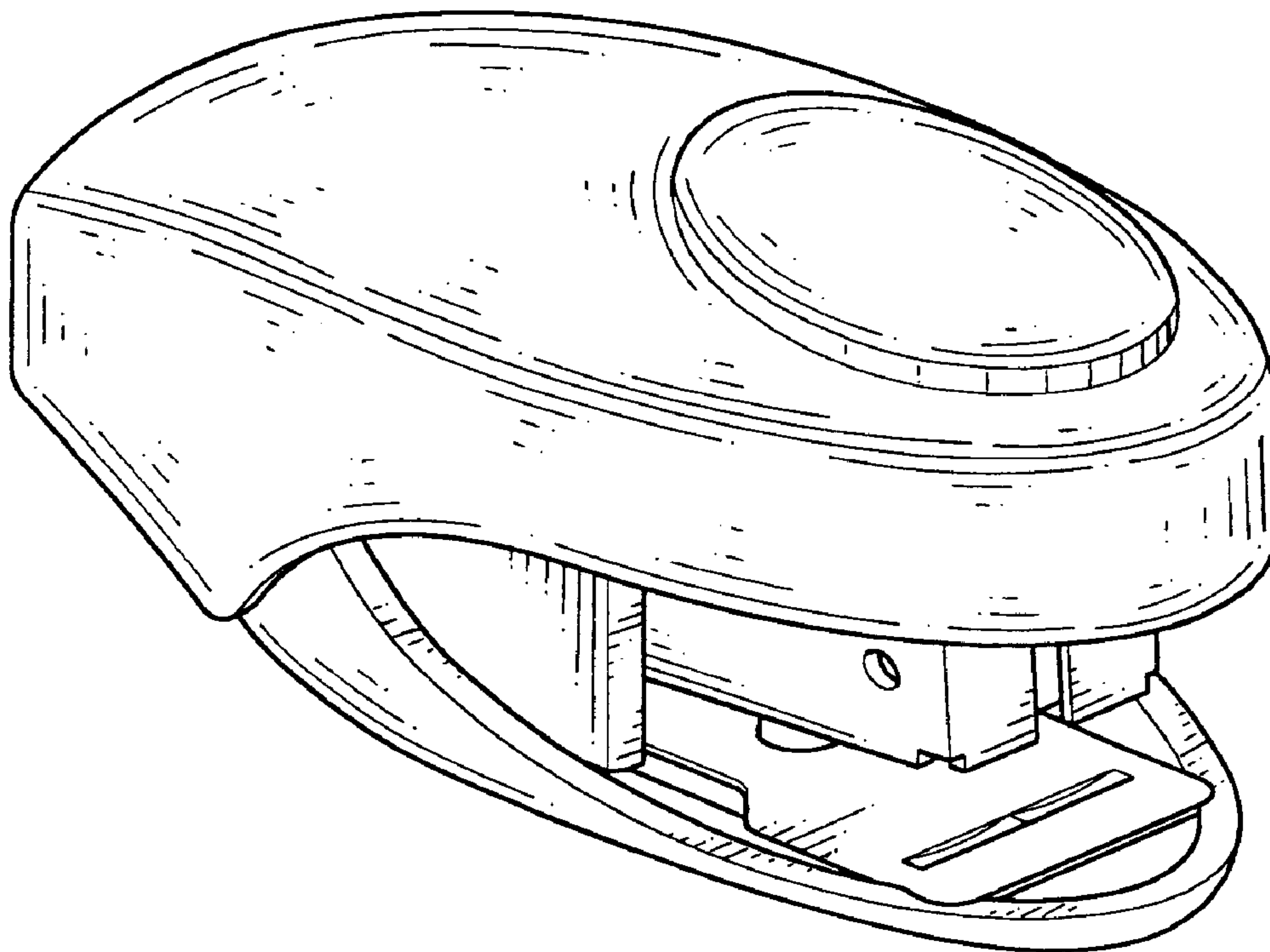

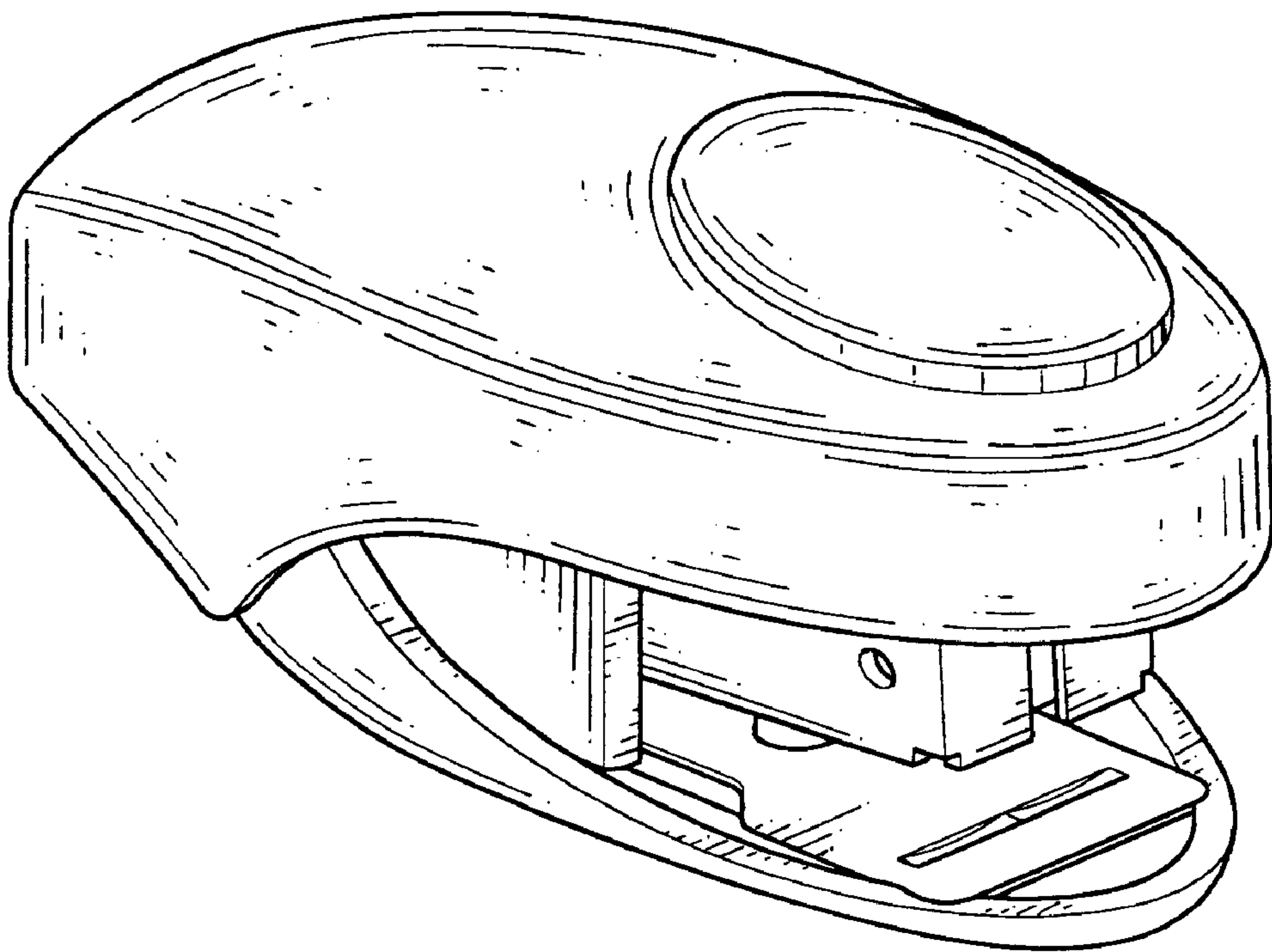

FIG.1

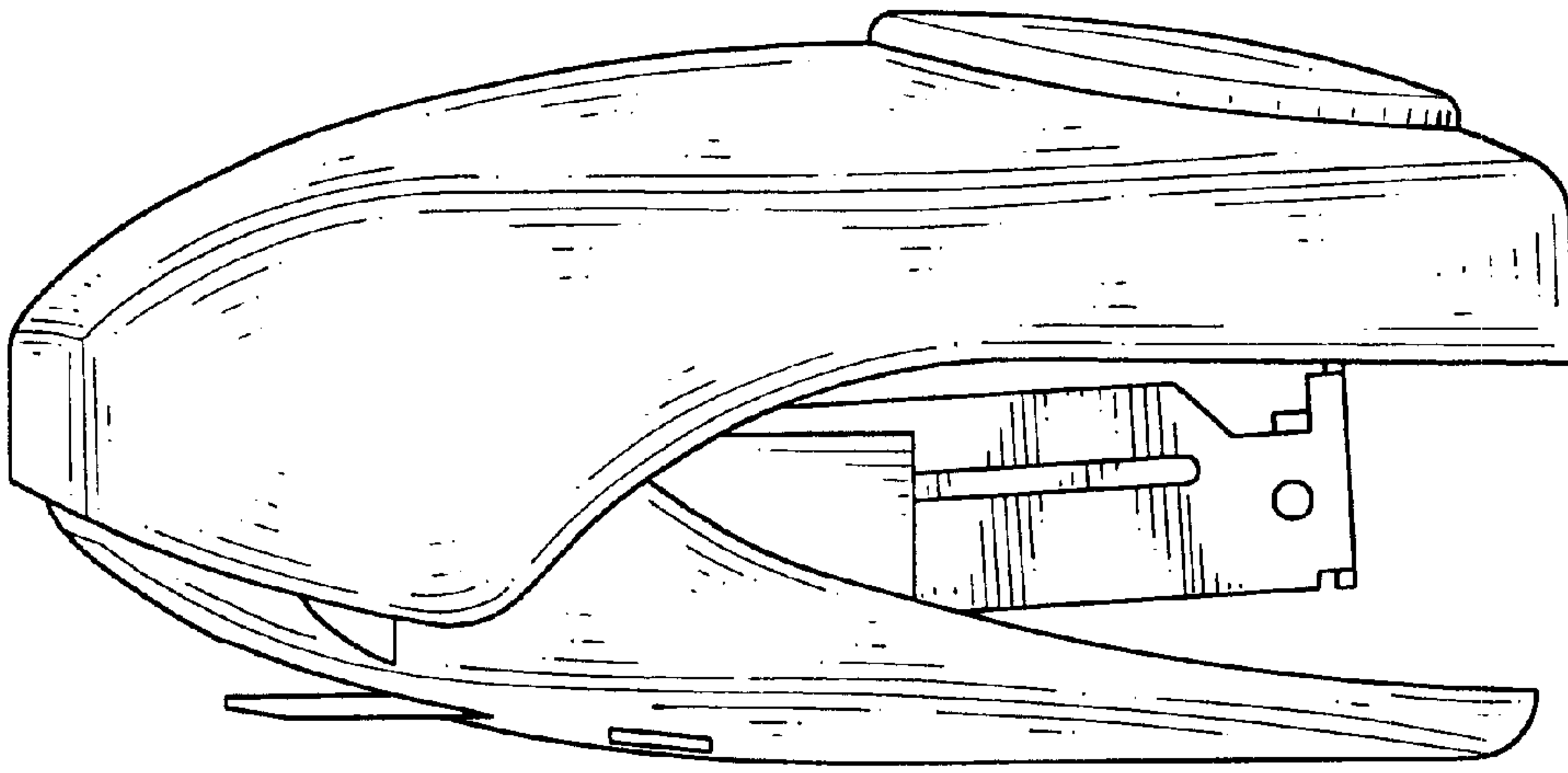

FIG. 2

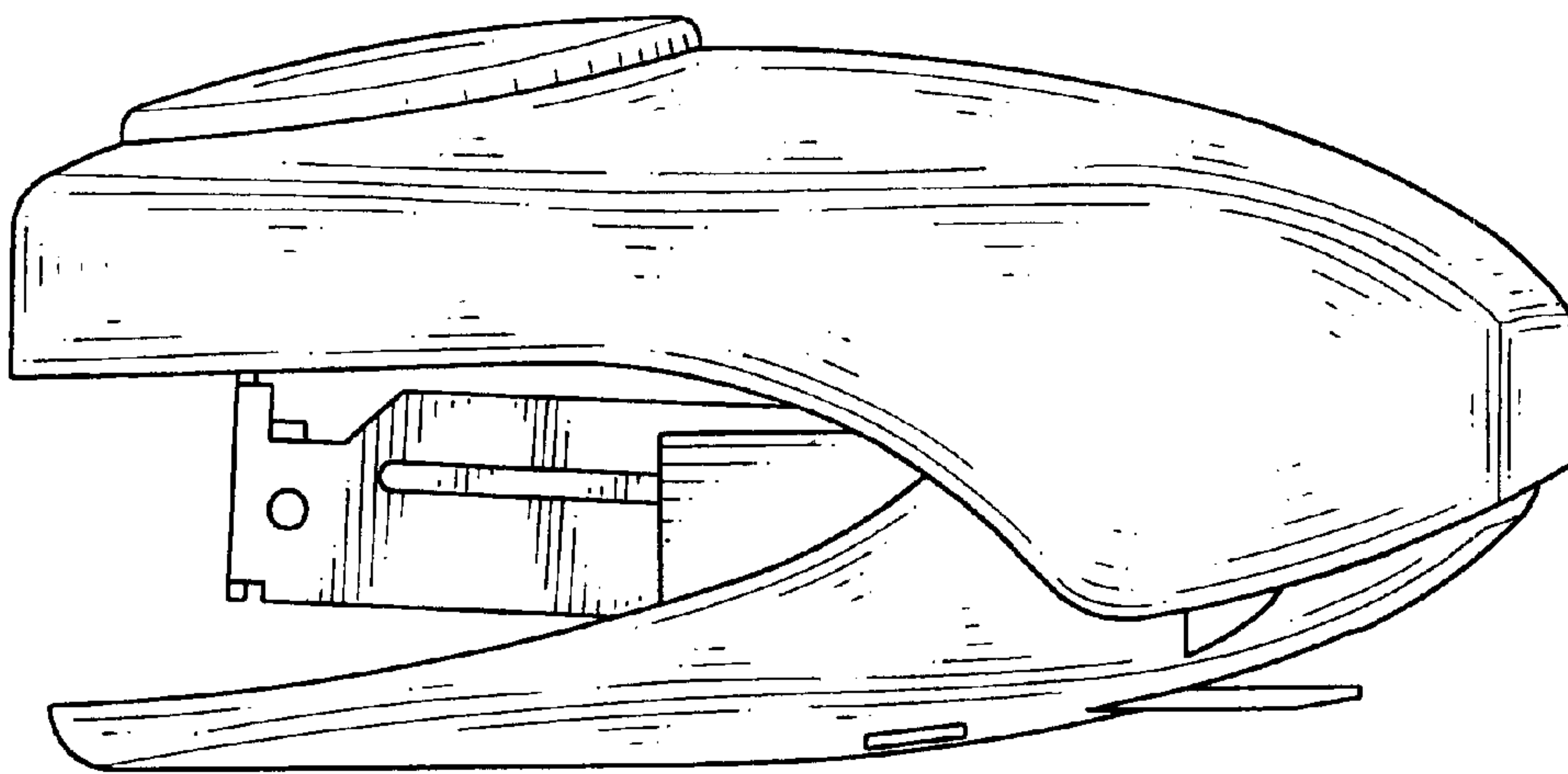

FIG. 3

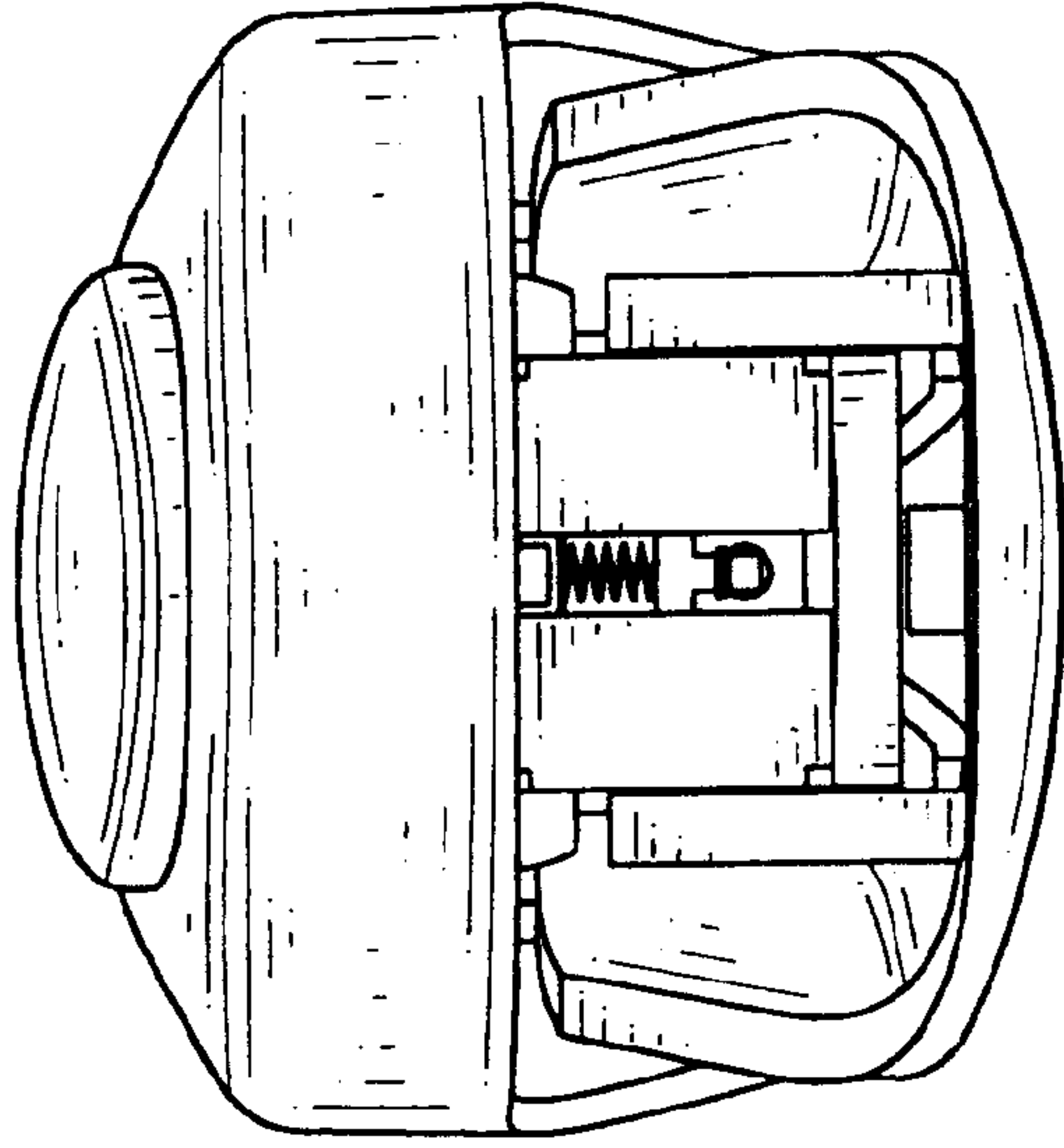

FIG.5

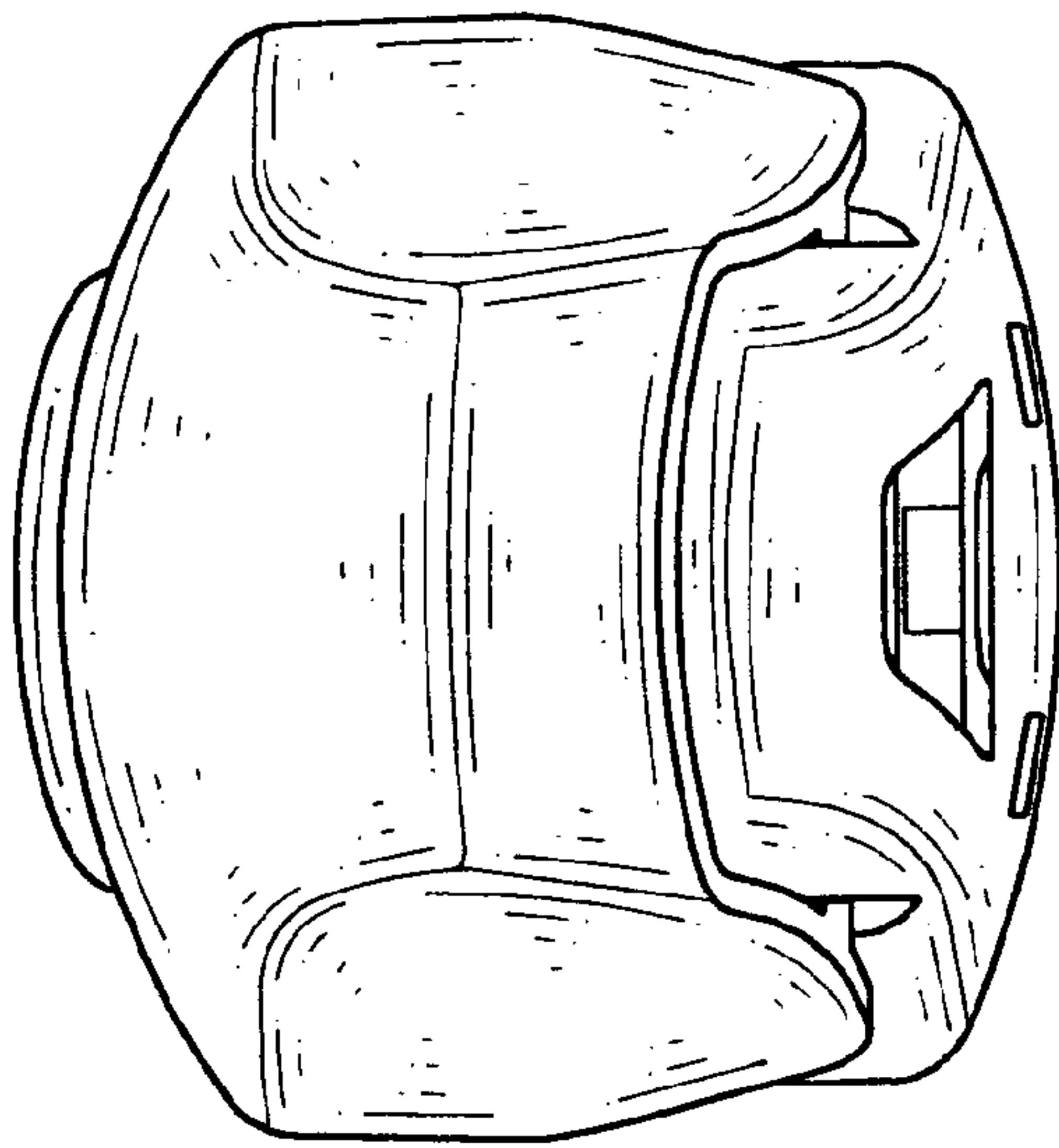

FIG.4

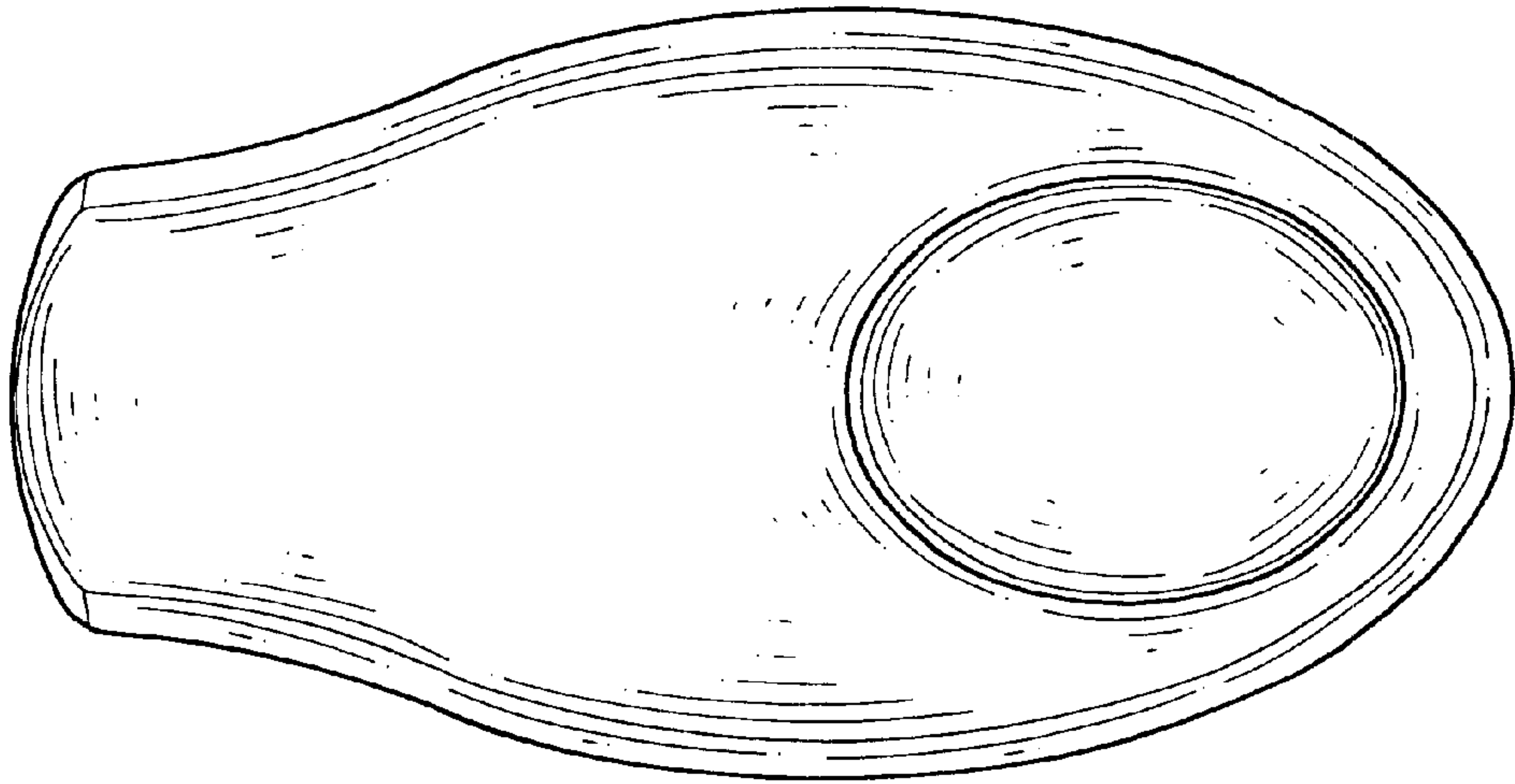

FIG. 6

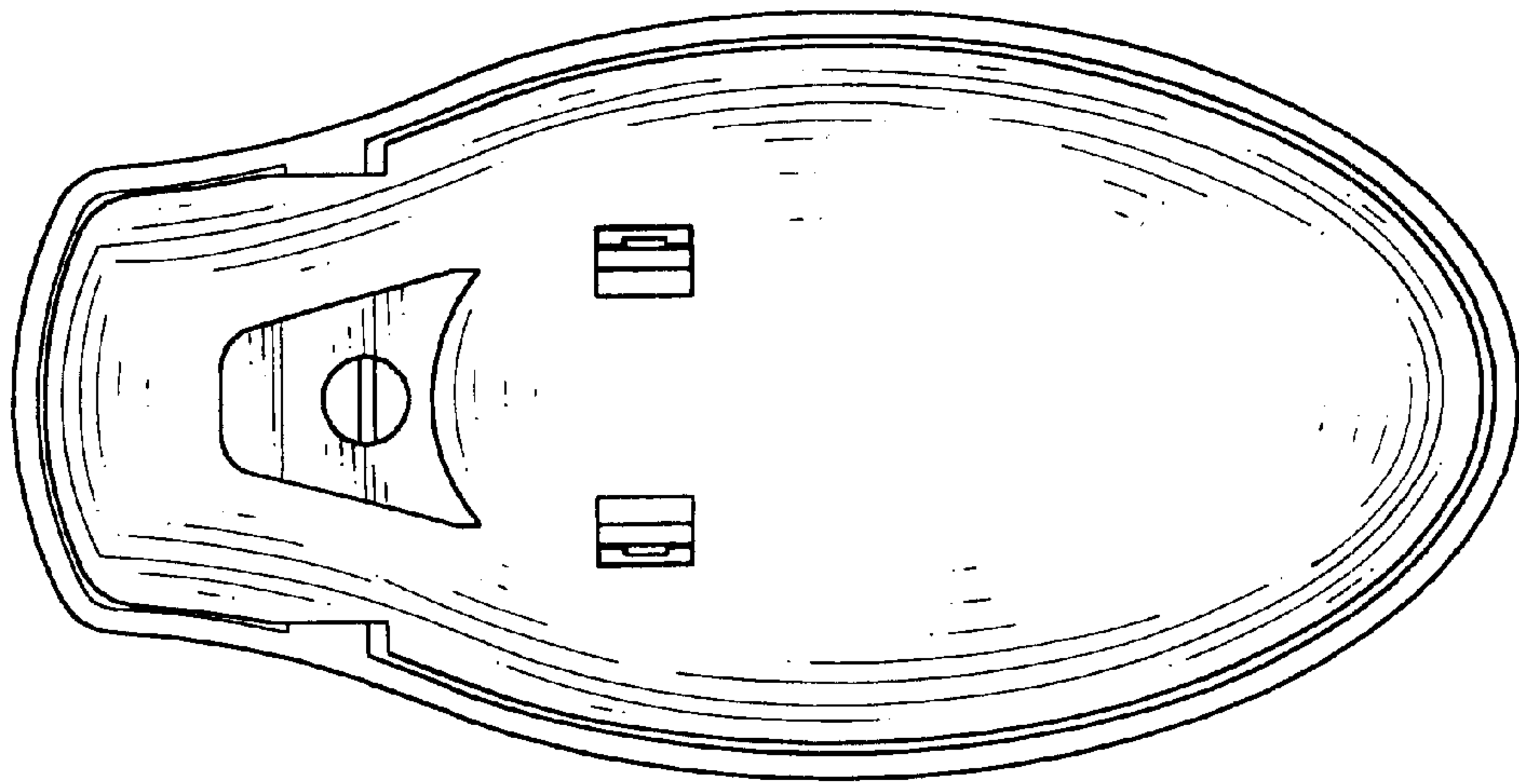

FIG. 7