



US00D478795S

(12) **United States Design Patent**
Hsieh

(10) **Patent No.:** **US D478,795 S**

(45) **Date of Patent:** **** Aug. 26, 2003**

(54) **SPANNER WITH BENDING HANDLE**

6,148,701 A * 11/2000 Lee 81/177.1
6,247,385 B1 * 6/2001 Wu 81/489

(76) Inventor: **Chih-Ching Hsieh**, 235 Chung - Ho
Box 8-24, Taipei (TW)

* cited by examiner

(**) Term: **14 Years**

Primary Examiner—Raphael Barkai

(21) Appl. No.: **29/169,078**

(57) **CLAIM**

(22) Filed: **Oct. 15, 2002**

The ornamental design for a spanner with bending handle, as shown and described.

(51) **LOC (7) Cl.** **08-05**

DESCRIPTION

(52) **U.S. Cl.** **D8/25**

(58) **Field of Search** D8/21-29; 81/60-63.2,
81/177.1, 177.85, 177.6, 489

FIG. 1 is a perspective view of a spanner with bending handle showing my new design;
FIG. 2 is a front elevational view thereof;
FIG. 3 is a rear elevational view thereof;
FIG. 4 is a right side view thereof;
FIG. 5 is a left side view thereof;
FIG. 6 is a top plan view thereof; and,
FIG. 7 is a bottom plan view thereof.

(56) **References Cited**

U.S. PATENT DOCUMENTS

D326,985 S * 6/1992 Chow D8/25
5,582,081 A * 12/1996 Lin 81/63.1
6,067,882 A * 5/2000 Hillinger 81/63
D434,292 S * 11/2000 Hsieh D8/28

1 Claim, 6 Drawing Sheets

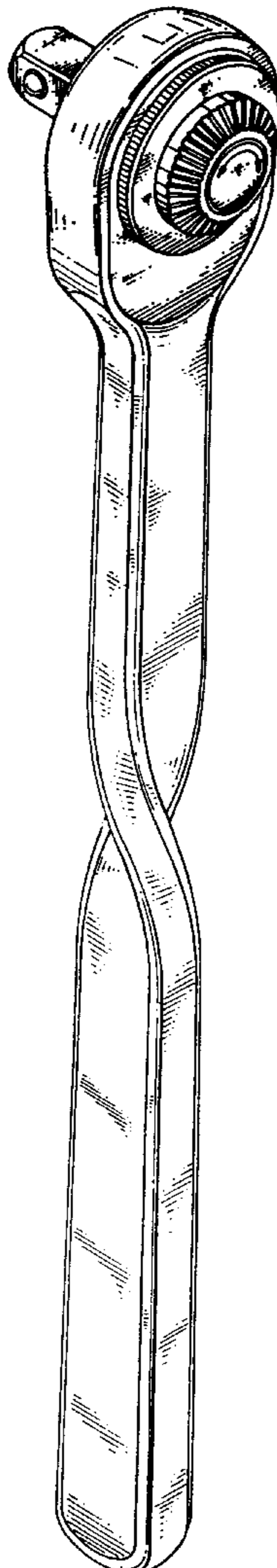

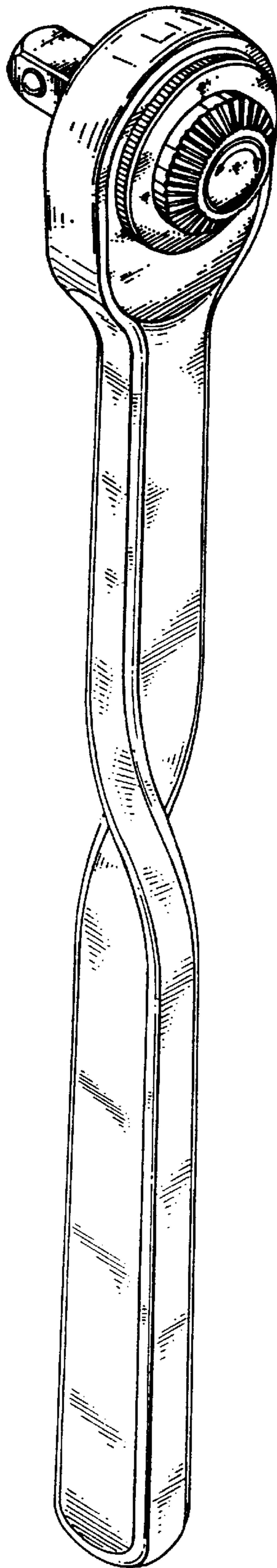

Fig . 1

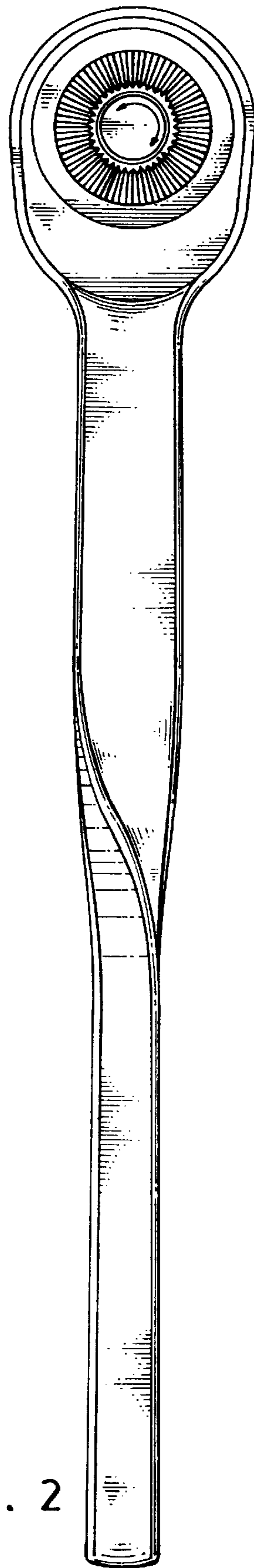

Fig . 2

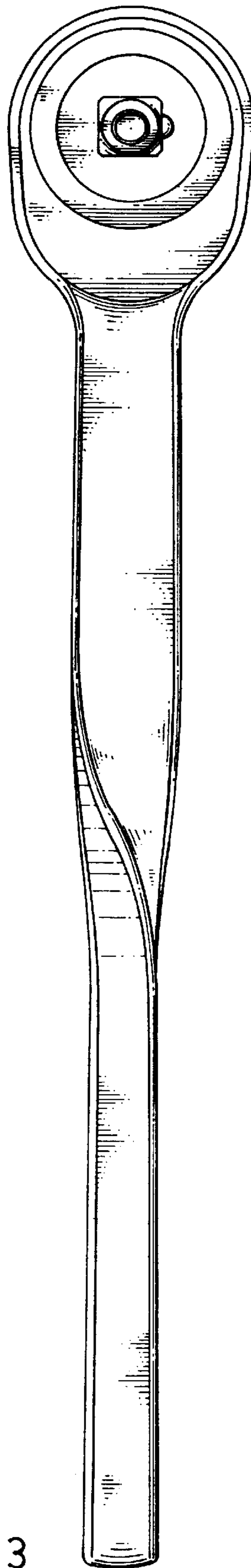

Fig . 3

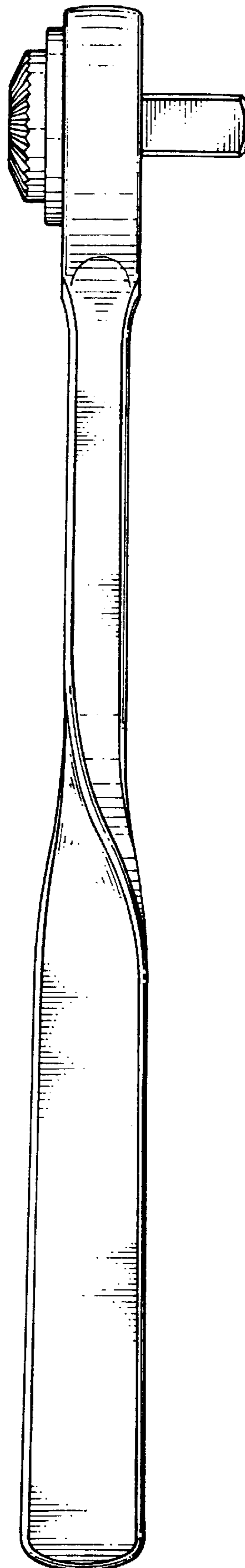

Fig . 4

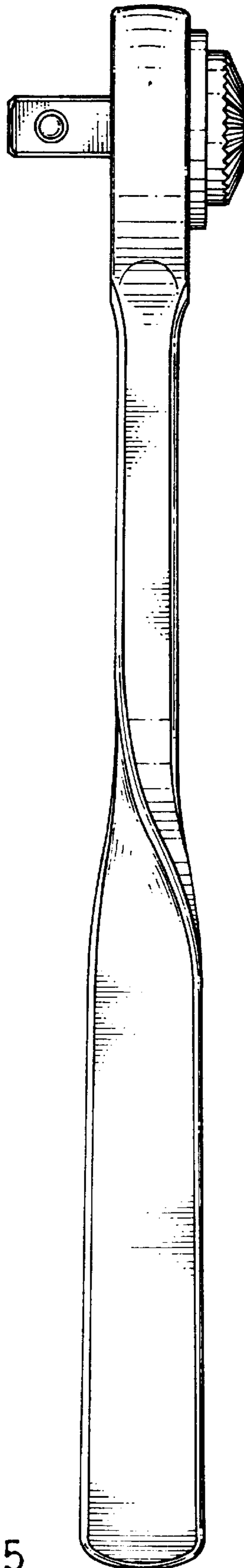

Fig . 5

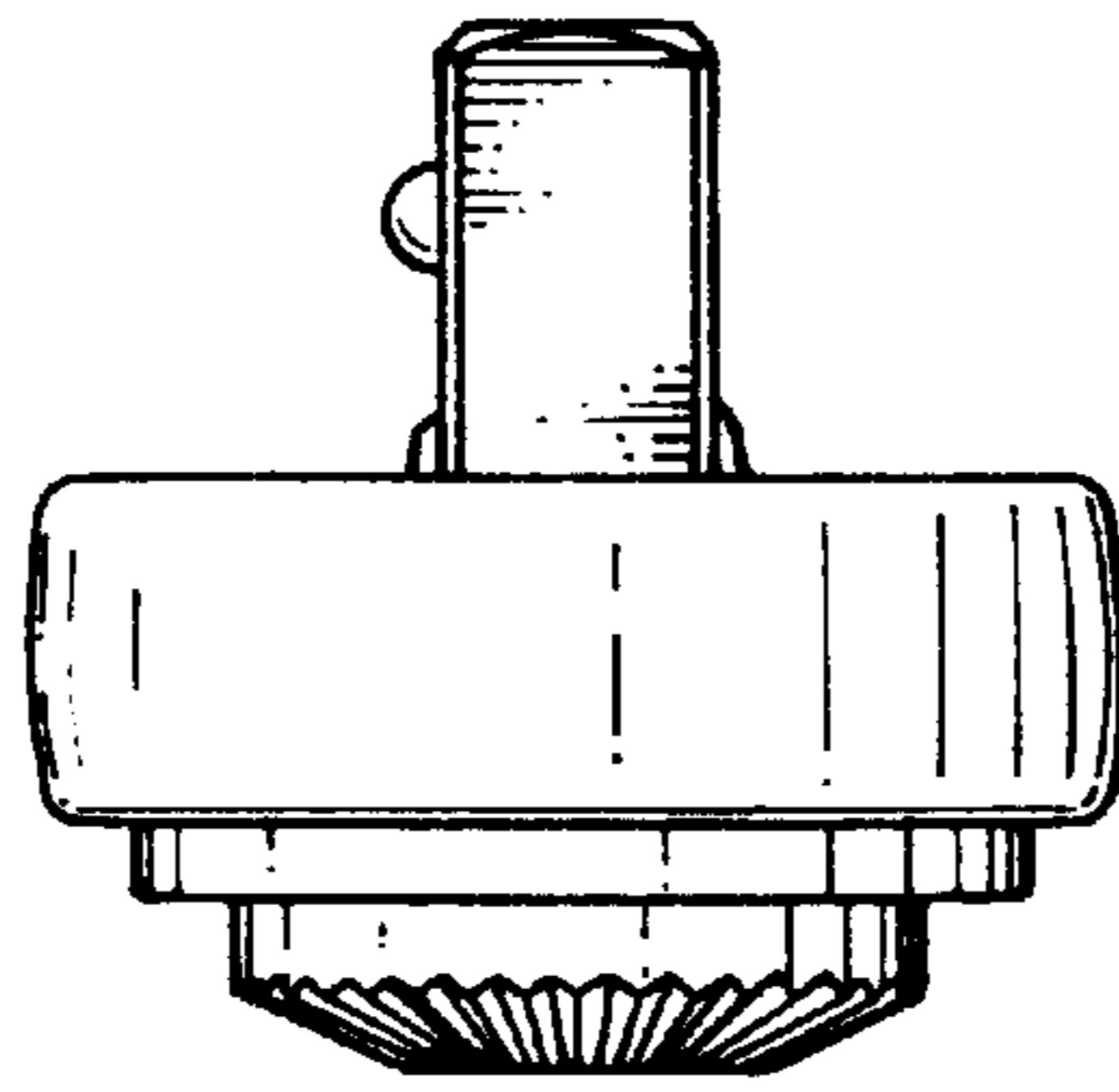

Fig . 6

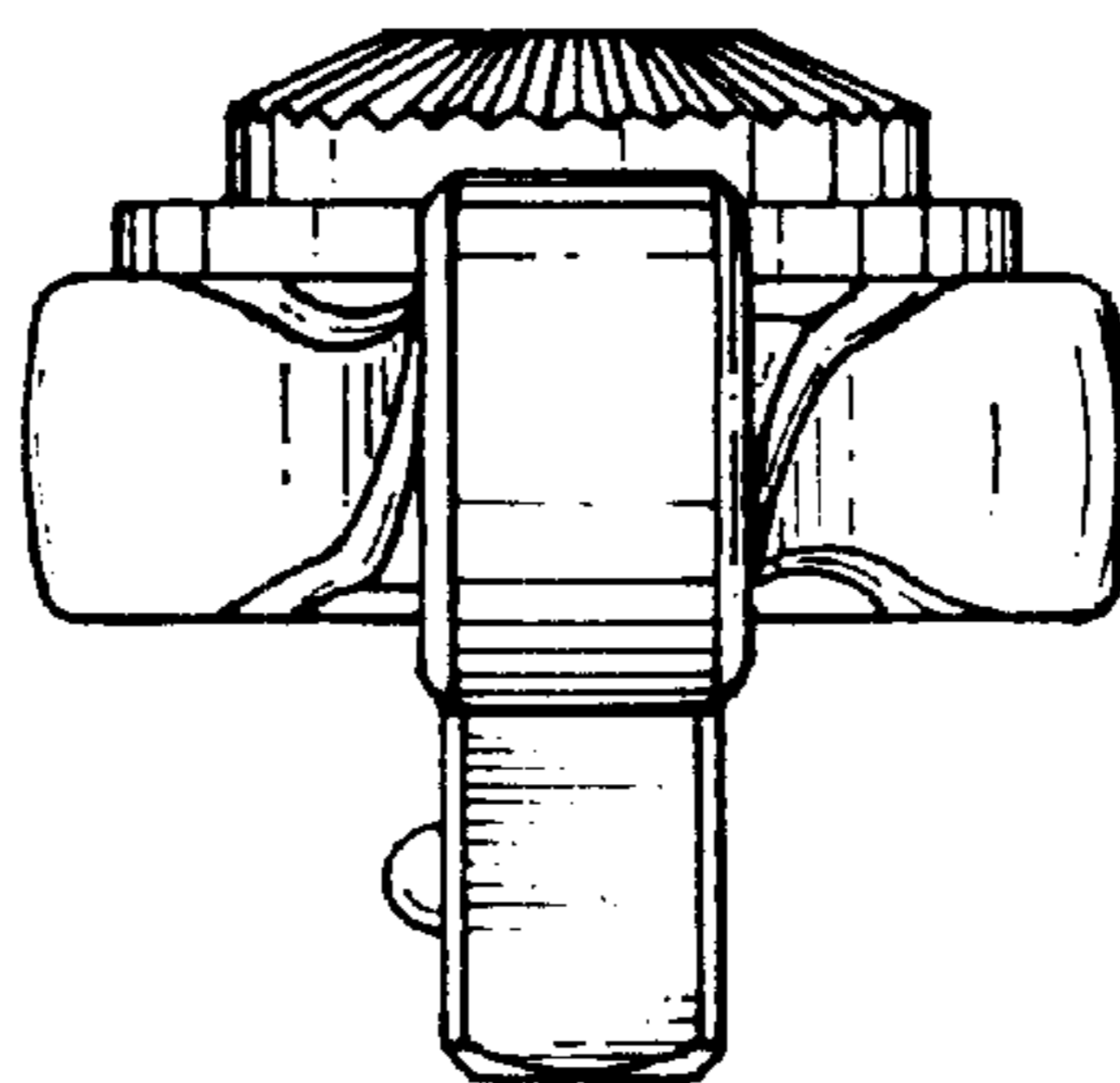

Fig . 7