



US00D478767S

(12) **United States Design Patent**
Lebowitz

(10) **Patent No.:** **US D478,767 S**

(45) **Date of Patent:** **** Aug. 26, 2003**

(54) **TEA KETTLE**

(75) **Inventor:** **Sam Lebowitz, New York, NY (US)**

(73) **Assignee:** **Wilton Industries, Inc., Woodridge, IL (US)**

(**) **Term:** **14 Years**

(21) **Appl. No.:** **29/162,337**

(22) **Filed:** **Jun. 13, 2002**

(51) **LOC (7) Cl.** **07-01**

(52) **U.S. Cl.** **D7/322; D7/321**

(58) **Field of Search** **D7/322, 321, 312, D7/302; 215/12.1, 12.2; 220/495.03, 23.87, 675, 756; 99/344; 222/511, 512, 544, 545, 472, 482, 475, 470; 116/137 R**

(56) **References Cited**

U.S. PATENT DOCUMENTS

D279,757 S	*	7/1985	Lax	D7/320
D282,810 S	*	3/1986	Urich	D7/322
D288,518 S	*	3/1987	Lebowitz	D7/322
D336,006 S	*	6/1993	Lebowitz	D7/322
D336,013 S		6/1993	Lebowitz		

D338,799 S		8/1993	Lebowitz		
D342,640 S	*	12/1993	Lebowitz	D7/322
D360,101 S	*	7/1995	Lee	D7/322
D380,337 S	*	7/1997	Lien	D7/322
D381,239 S	*	7/1997	Chen	D7/322
D407,943 S	*	4/1999	Chen	D7/322
D414,979 S	*	10/1999	de Bergen	D7/320
D442,015 S	*	5/2001	Doret, Jr.	D7/322

* cited by examiner

Primary Examiner—M. N. Pandozzi

(74) *Attorney, Agent, or Firm*—Piper Rudnick

(57) **CLAIM**

The ornamental design for the tea kettle, as shown.

DESCRIPTION

FIG. 1 is a perspective view of the tea kettle;
FIG. 2 is a front elevational view of the tea kettle;
FIG. 3 is a back elevational view of the tea kettle;
FIG. 4 is a right side elevational view of the tea kettle;
FIG. 5 is a left side elevational view of the tea kettle;
FIG. 6 is a top plan view of the tea kettle; and,
FIG. 7 is a bottom plan view of the tea kettle.

1 Claim, 4 Drawing Sheets

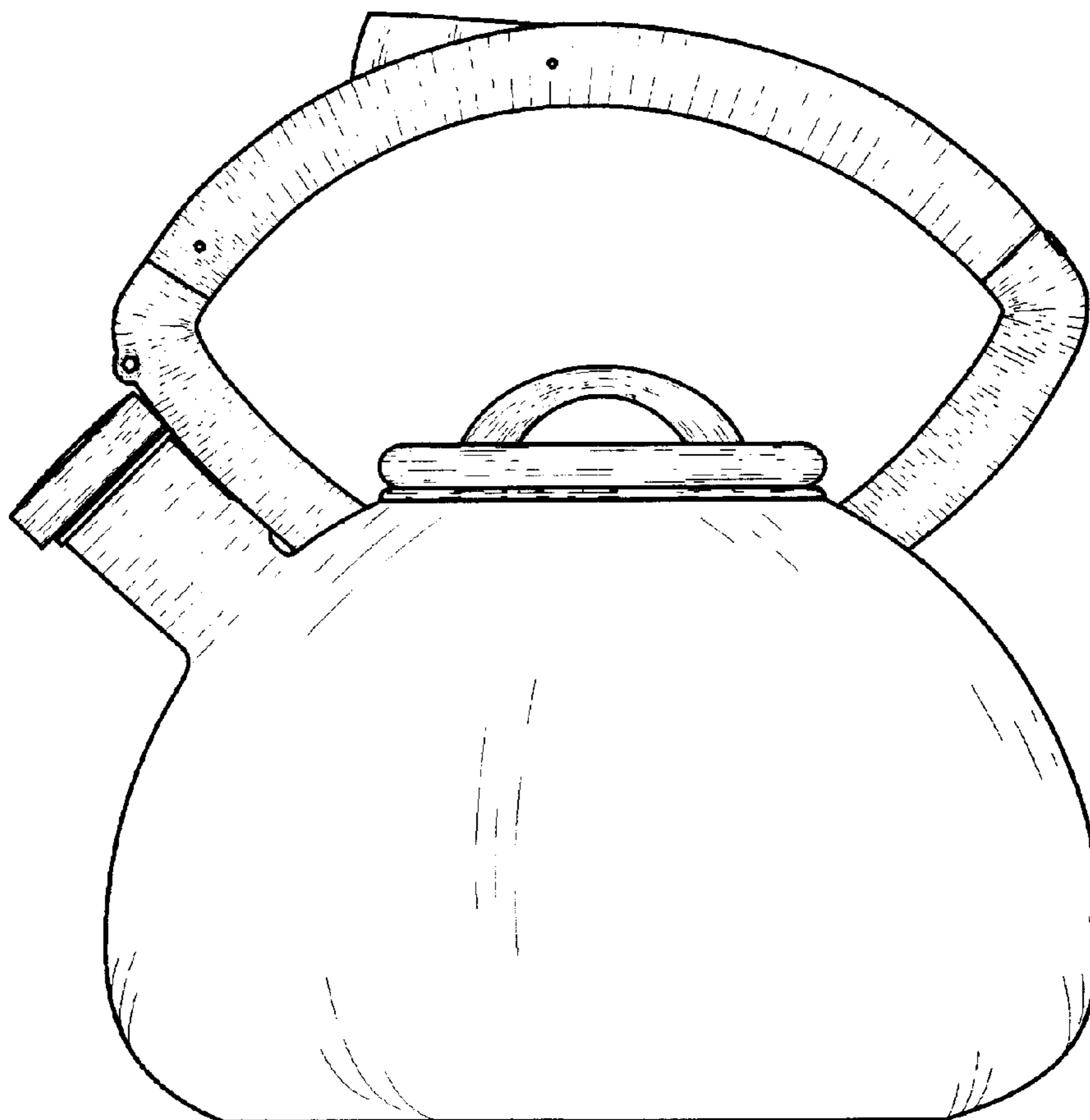

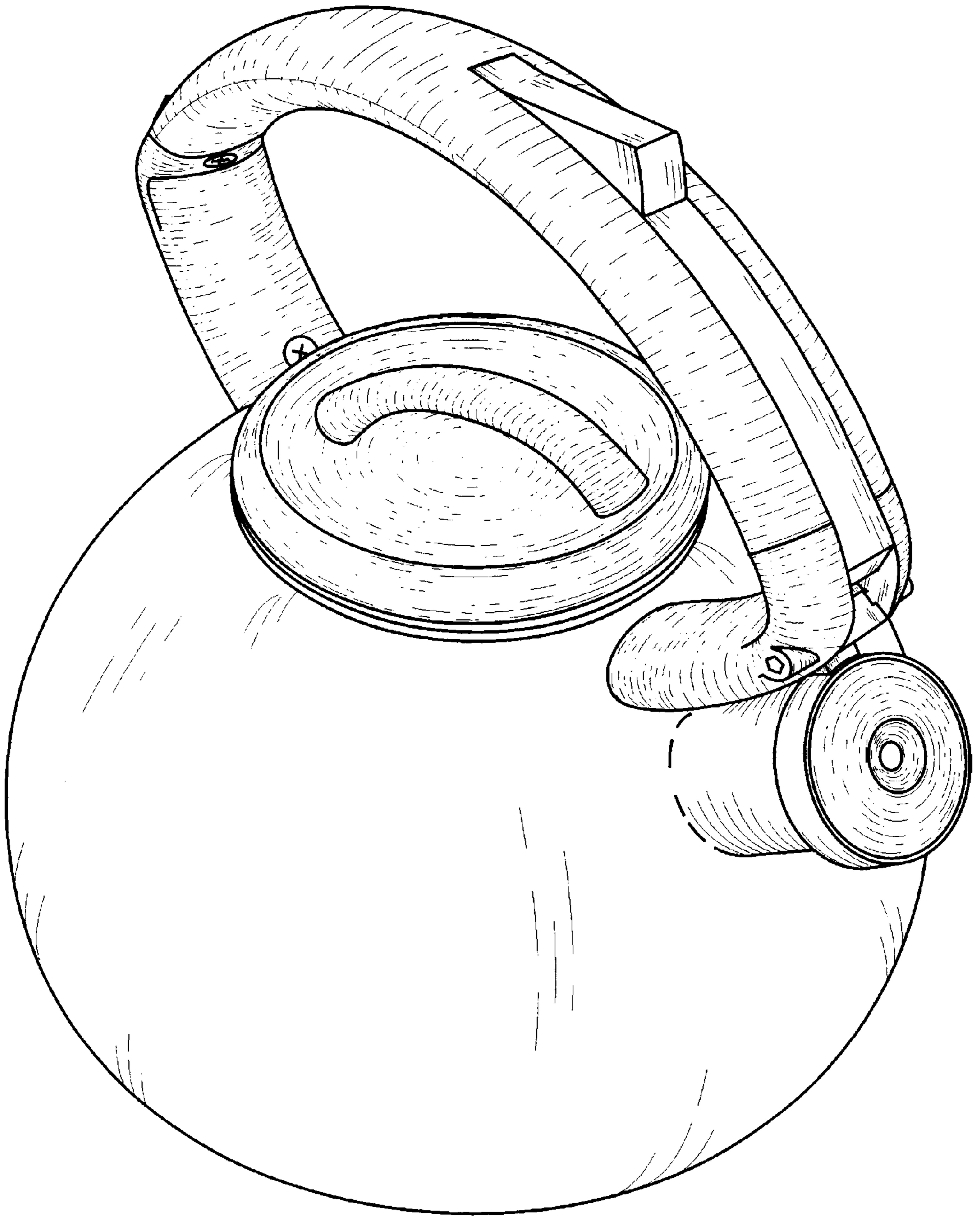

FIG. 1

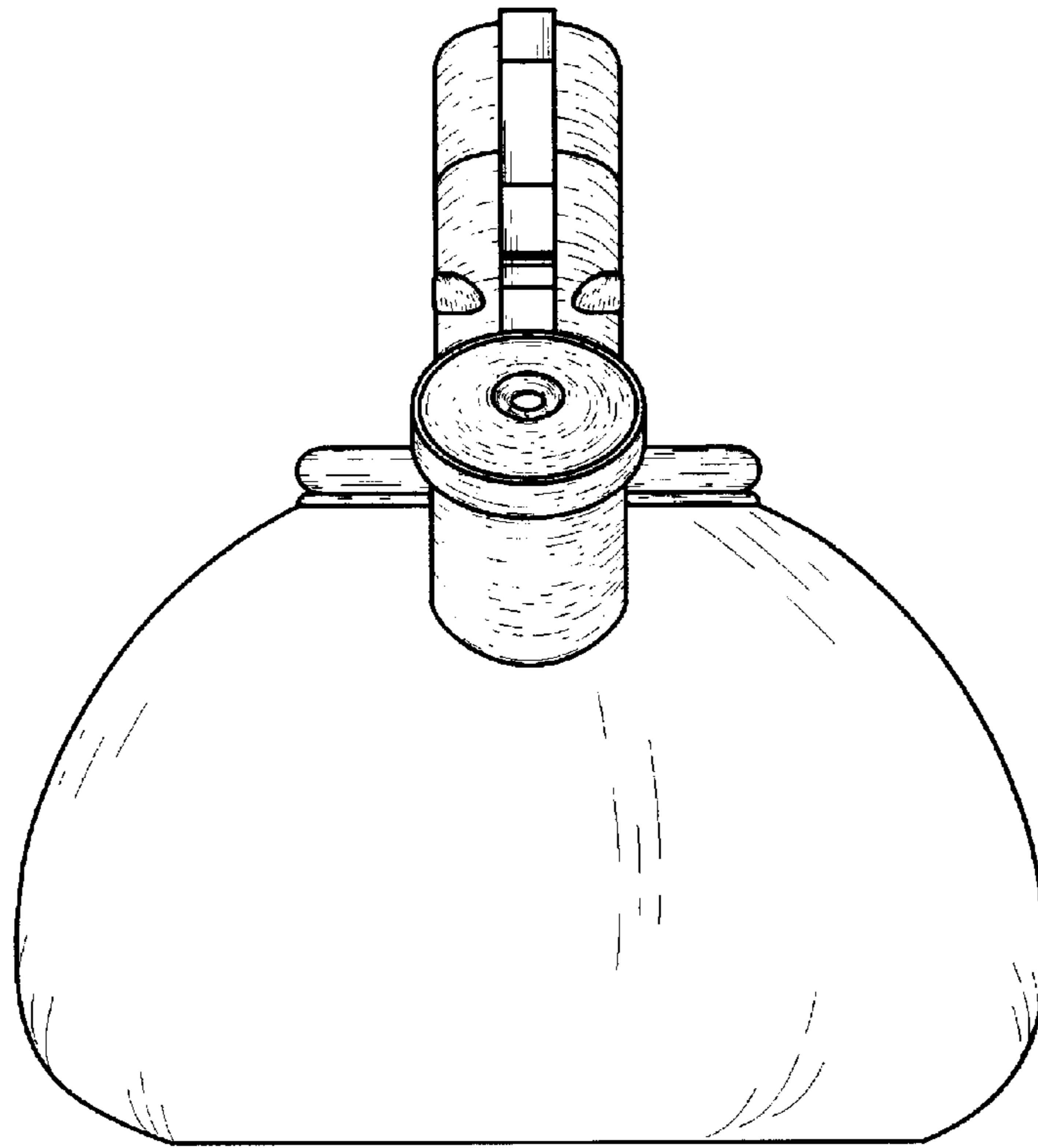

FIG. 2

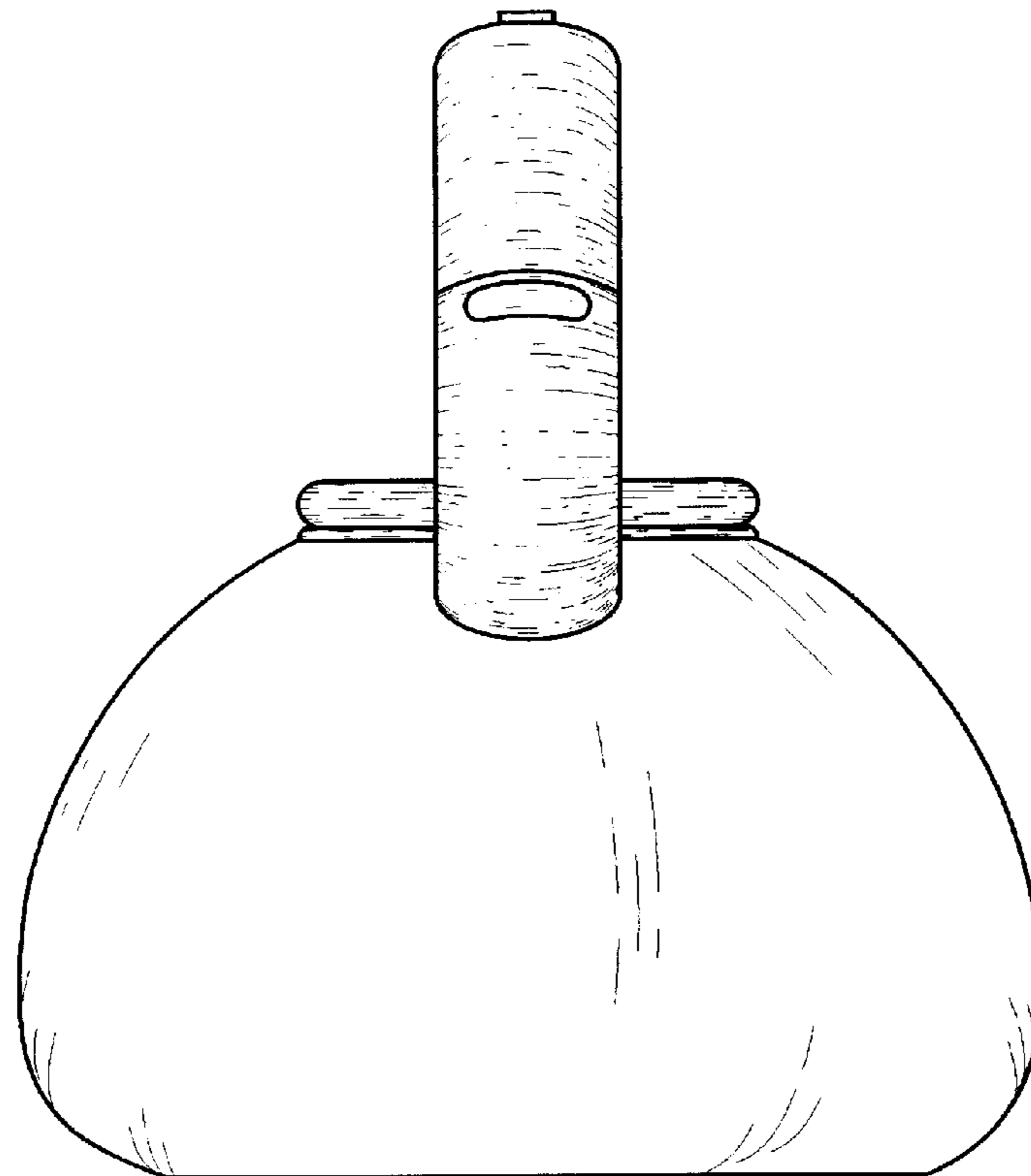

FIG. 3

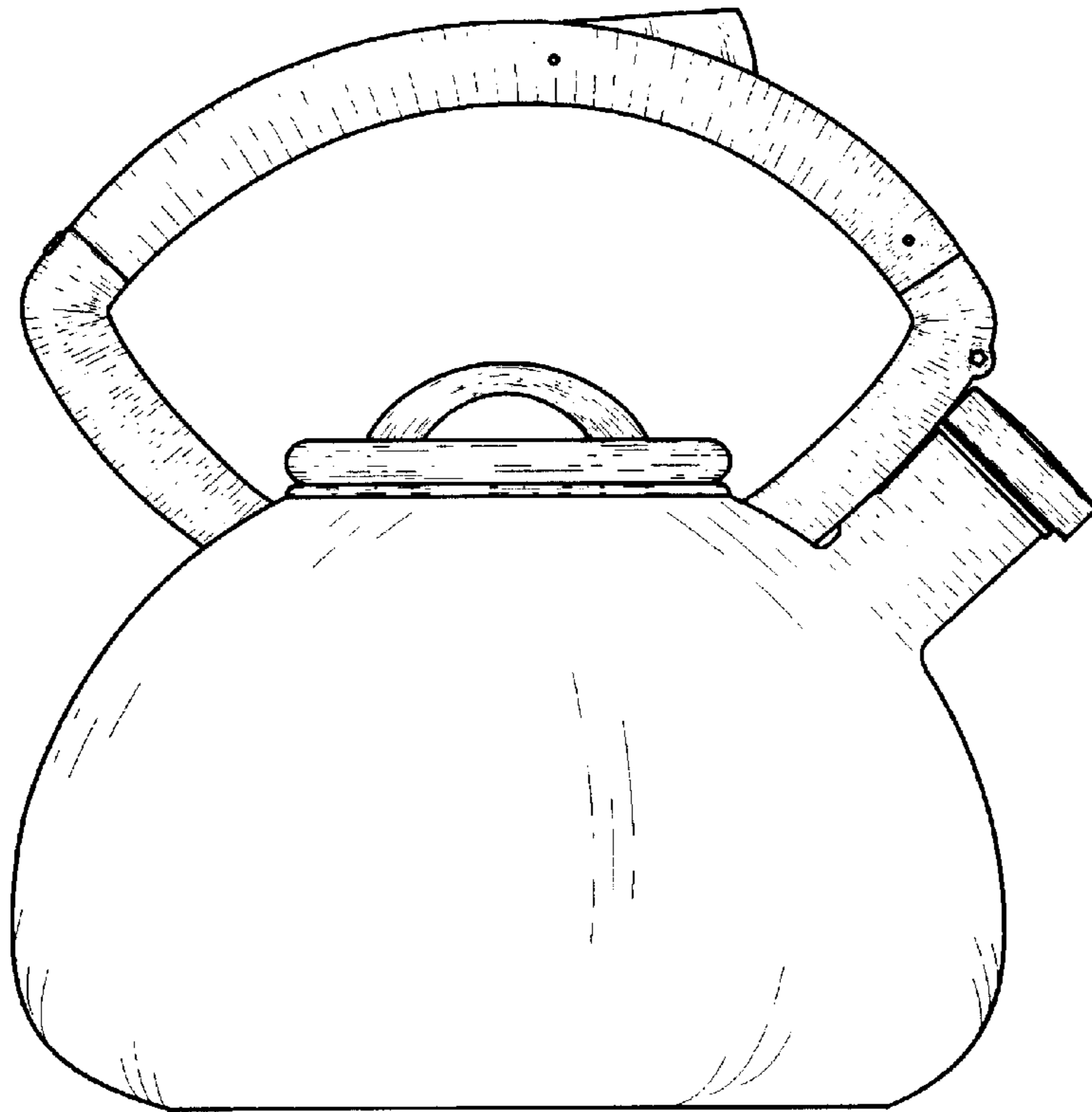

FIG. 4

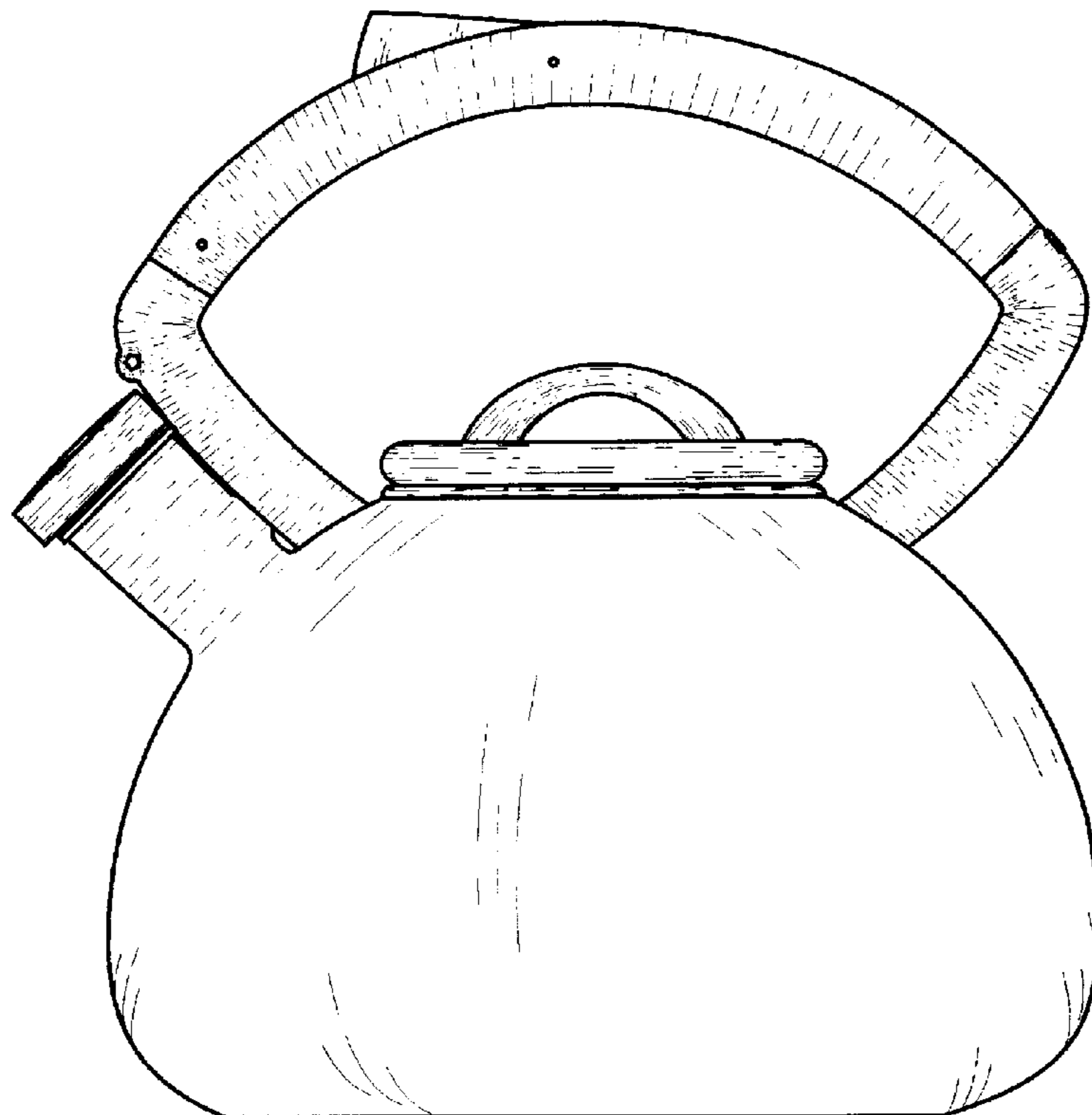

FIG. 5

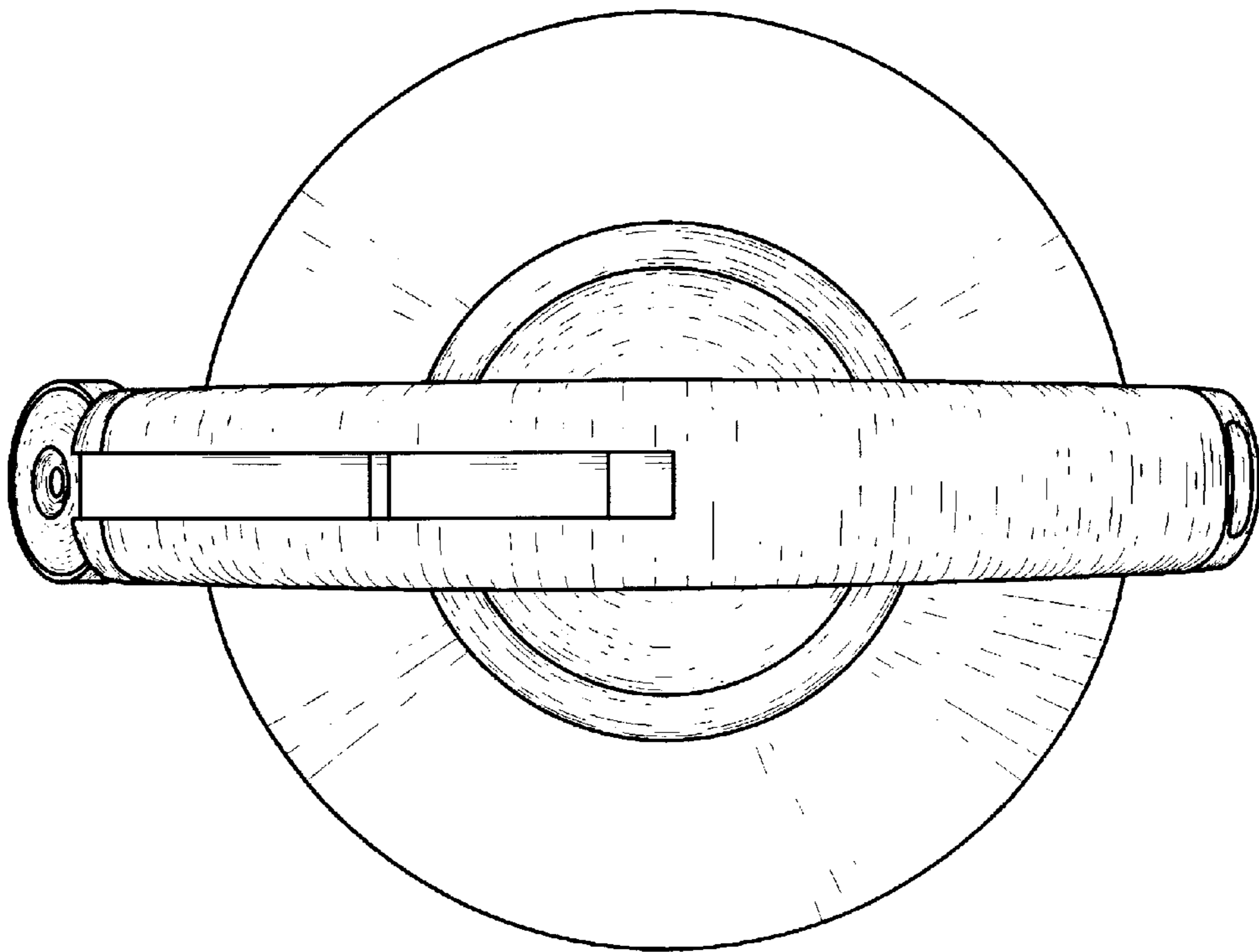

FIG. 6

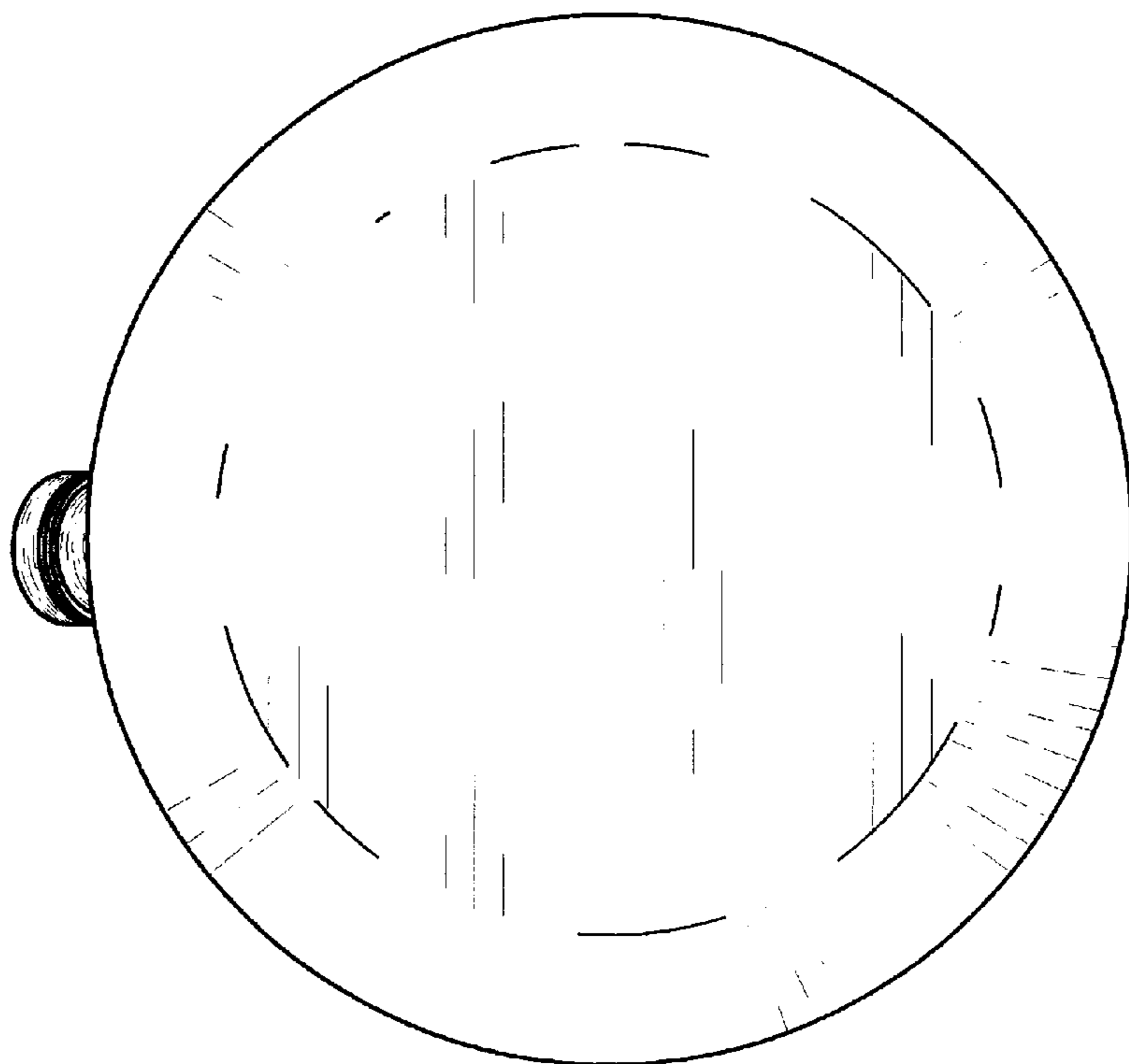

FIG. 7