



US00D478735S

(12) **United States Design Patent**
Sellers

(10) **Patent No.:** **US D478,735 S**

(45) **Date of Patent:** **** Aug. 26, 2003**

(54) **POTTED PLANT STAND**

(76) Inventor: **Kathleen R. Sellers**, 3594 S. Ocean Blvd., #301, Highland Beach, FL (US) 33487

(**) Term: **14 Years**

(21) Appl. No.: **29/168,456**

(22) Filed: **Oct. 2, 2002**

(51) **LOC (7) Cl.** **06-06**

(52) **U.S. Cl.** **D6/403**

(58) **Field of Search** D11/143, 144, D11/152, 153, 154; D6/403, 404, 405, 408-484, 556; D7/403, 704; D8/370; 47/39, 41.01, 65.5, 71; 206/423; 211/106, 85.31, 85.23; 248/27.8, 127

(56) **References Cited**

U.S. PATENT DOCUMENTS

D204,006 S	*	3/1966	Reed	D6/403
D365,700 S	*	1/1996	Lee	D6/403
D369,698 S	*	5/1996	Hollinger	D6/405
D434,247 S	*	11/2000	Rosenberg	D6/403
D449,179 S	*	10/2001	Sellers	D6/403
D449,180 S	*	10/2001	Blake	D6/403

* cited by examiner

Primary Examiner—Doris V. Coles
Assistant Examiner—Mimosa De

(74) *Attorney, Agent, or Firm*—Malin, Haley & DiMaggio, P.A.

(57) **CLAIM**

The ornamental design for a potted plant stand, as shown and described.

DESCRIPTION

FIG. 1 is a perspective view of the first embodiment of the potted plant stand showing the new design;
 FIG. 2 is a right side elevational view thereof; the left side elevational view is a mirror image thereof;
 FIG. 3 is a front elevational view thereof;
 FIG. 4 is a rear elevational view thereof;
 FIG. 5 is a top plan view thereof;
 FIG. 6 is a bottom plan view thereof;
 FIG. 7 is a perspective view of the second embodiment of the invention;
 FIG. 8 is a right side elevational view of the second embodiment of the invention;
 FIG. 9 is a front elevational view of the second embodiment of the invention;
 FIG. 10 is a rear elevational view of the second embodiment of the invention;
 FIG. 11 is a top plan view of the second embodiment of the invention; and,
 FIG. 12 is a bottom plan view of the second embodiment of the invention.

1 Claim, 12 Drawing Sheets

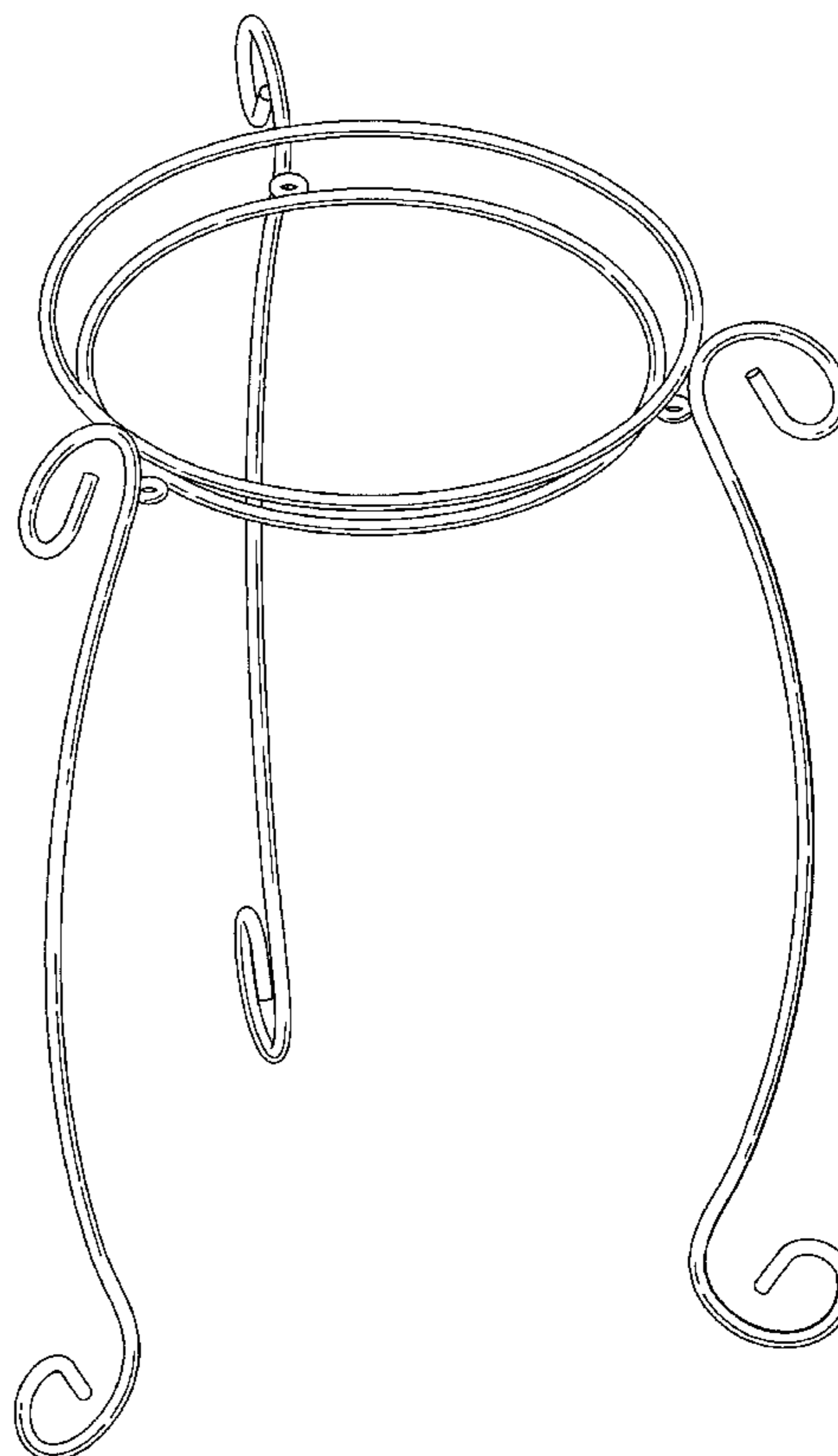
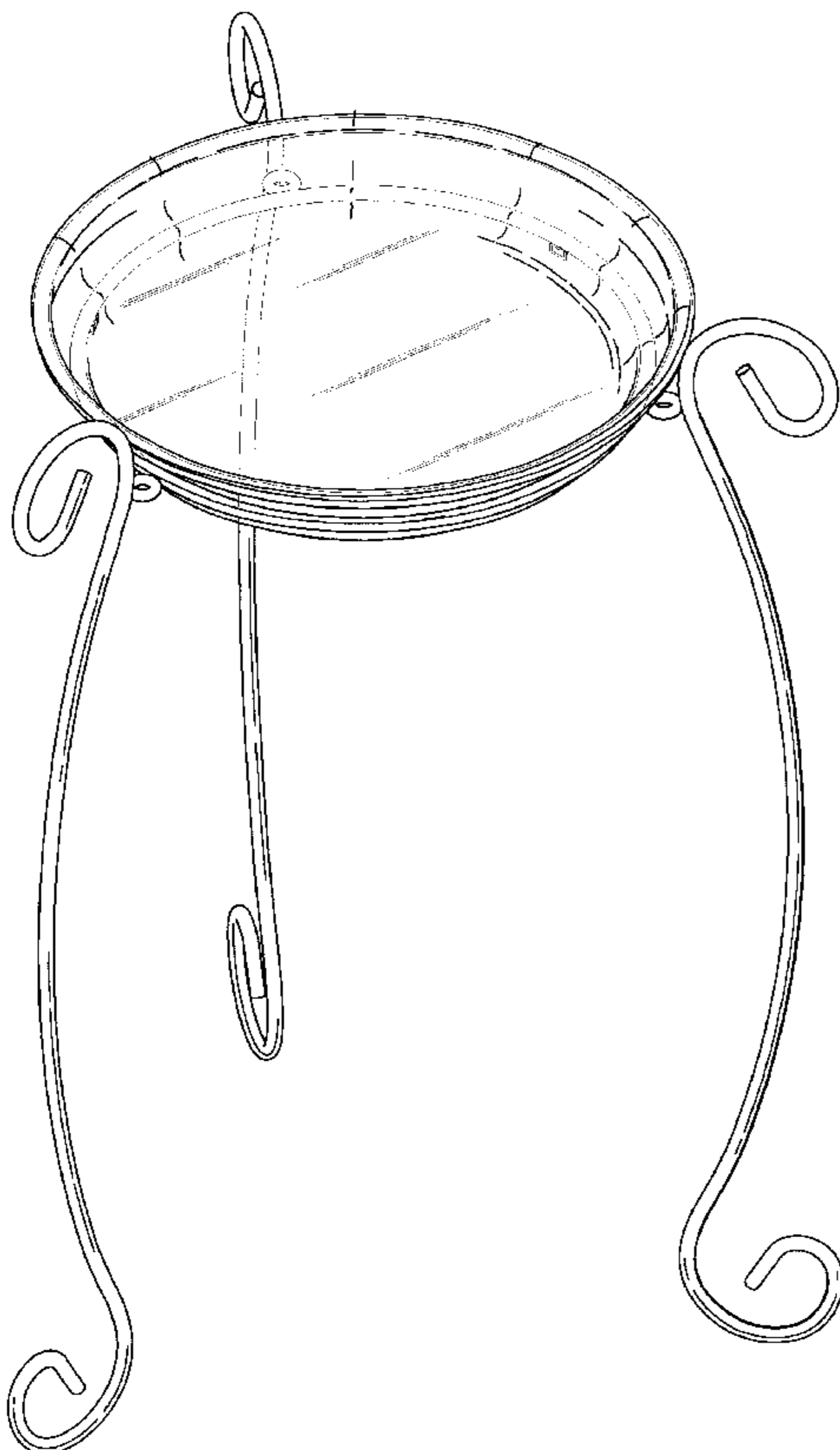

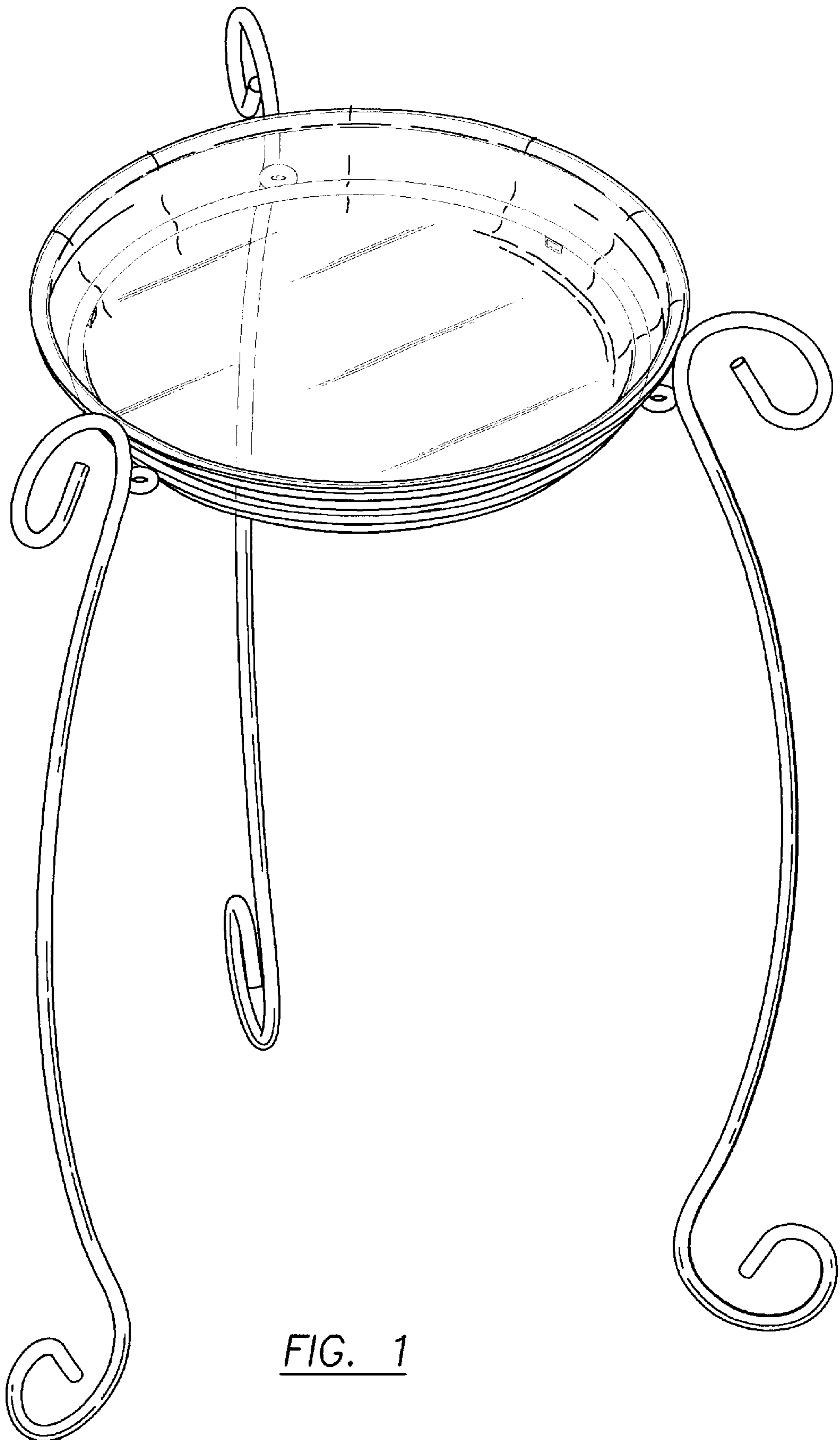

FIG. 1

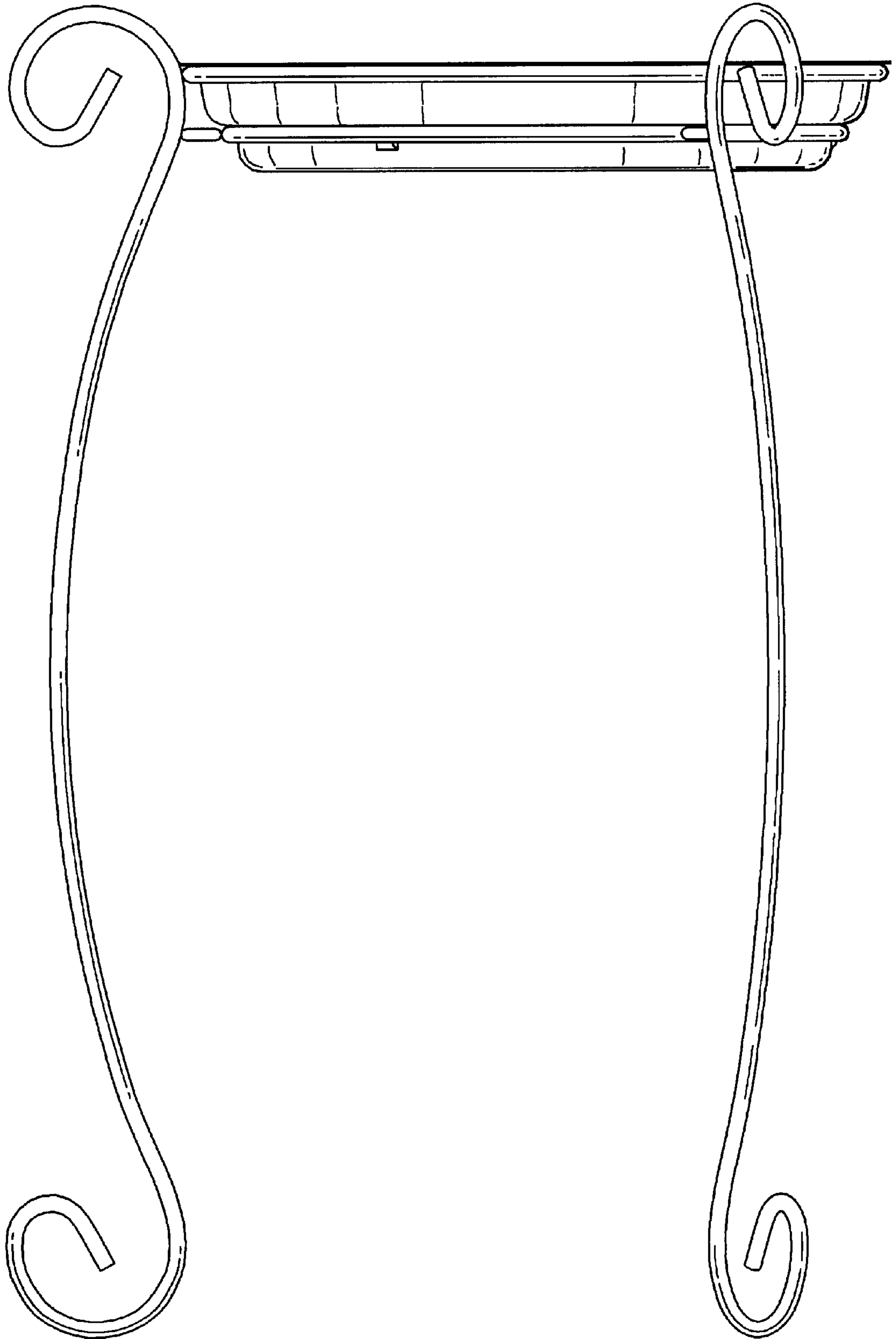

FIG. 2

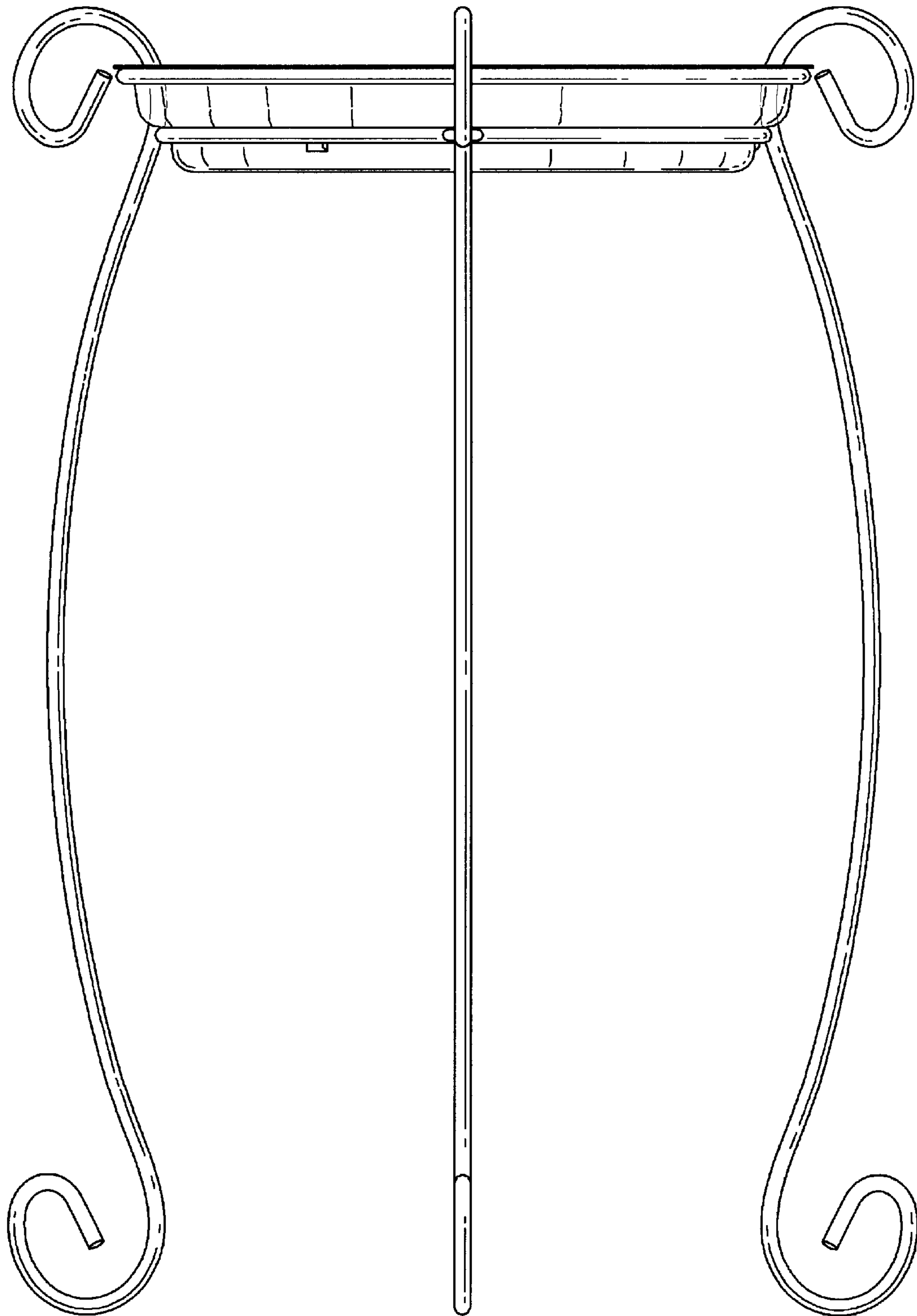

FIG. 3

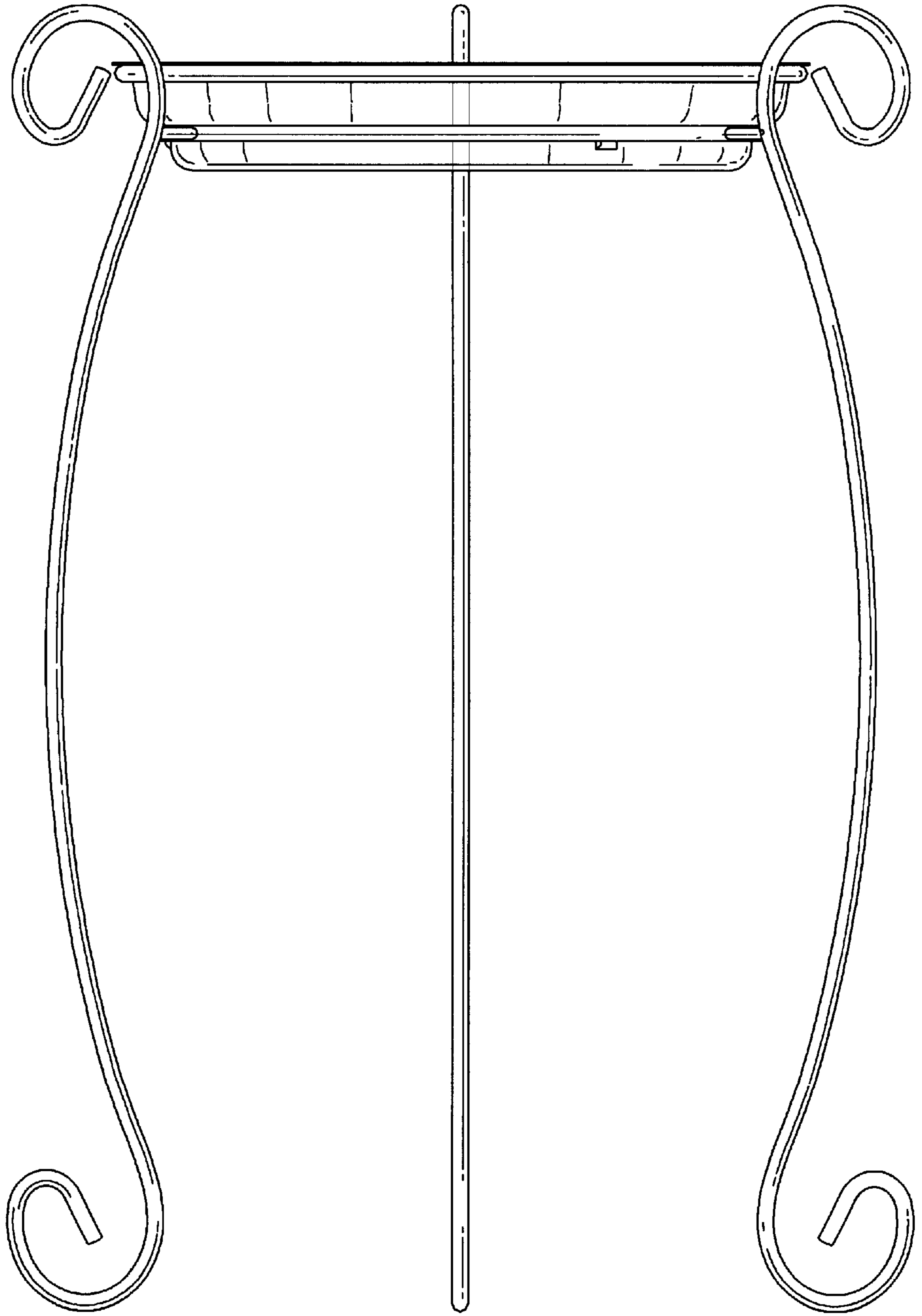

FIG. 4

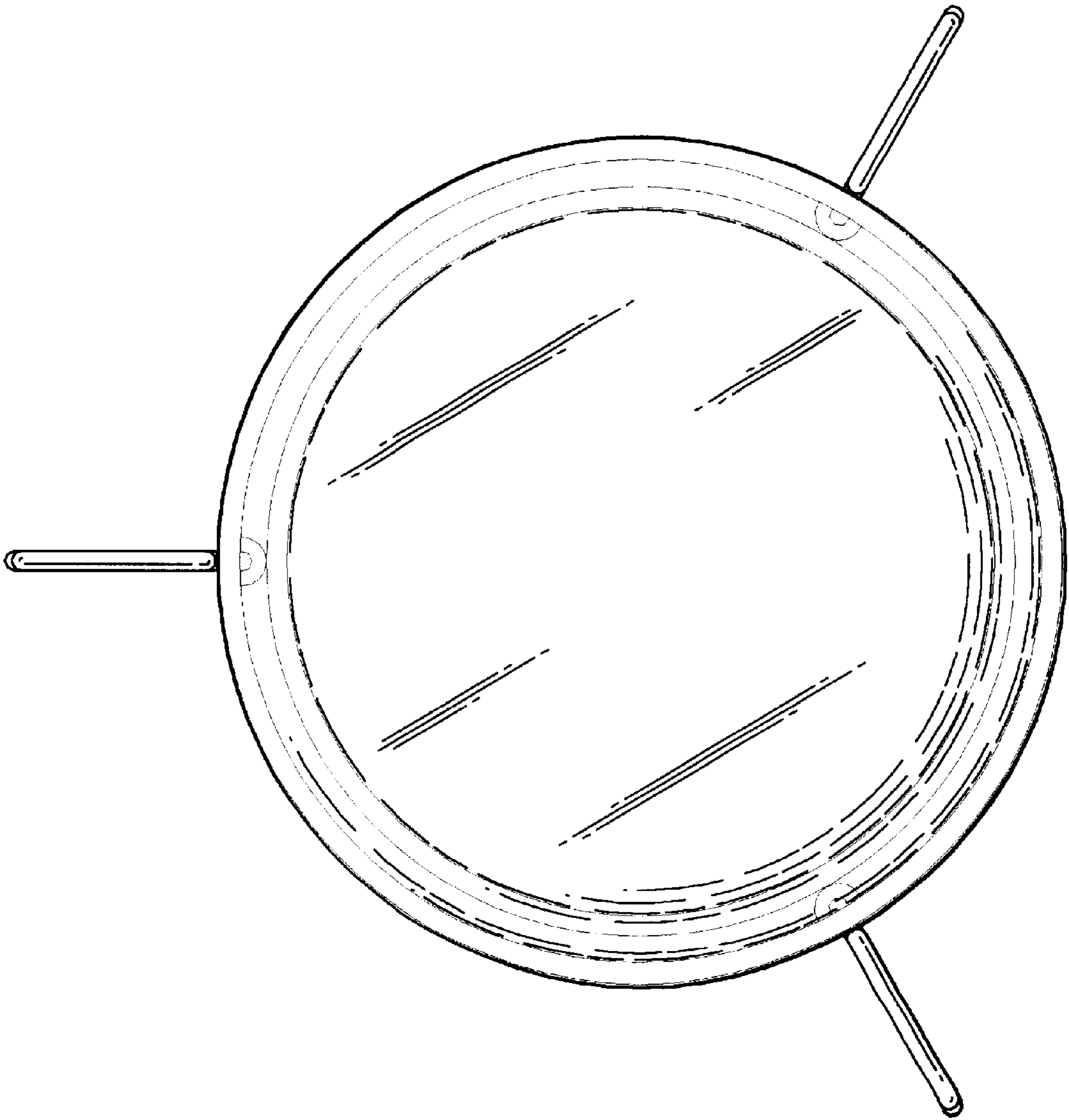

FIG. 5

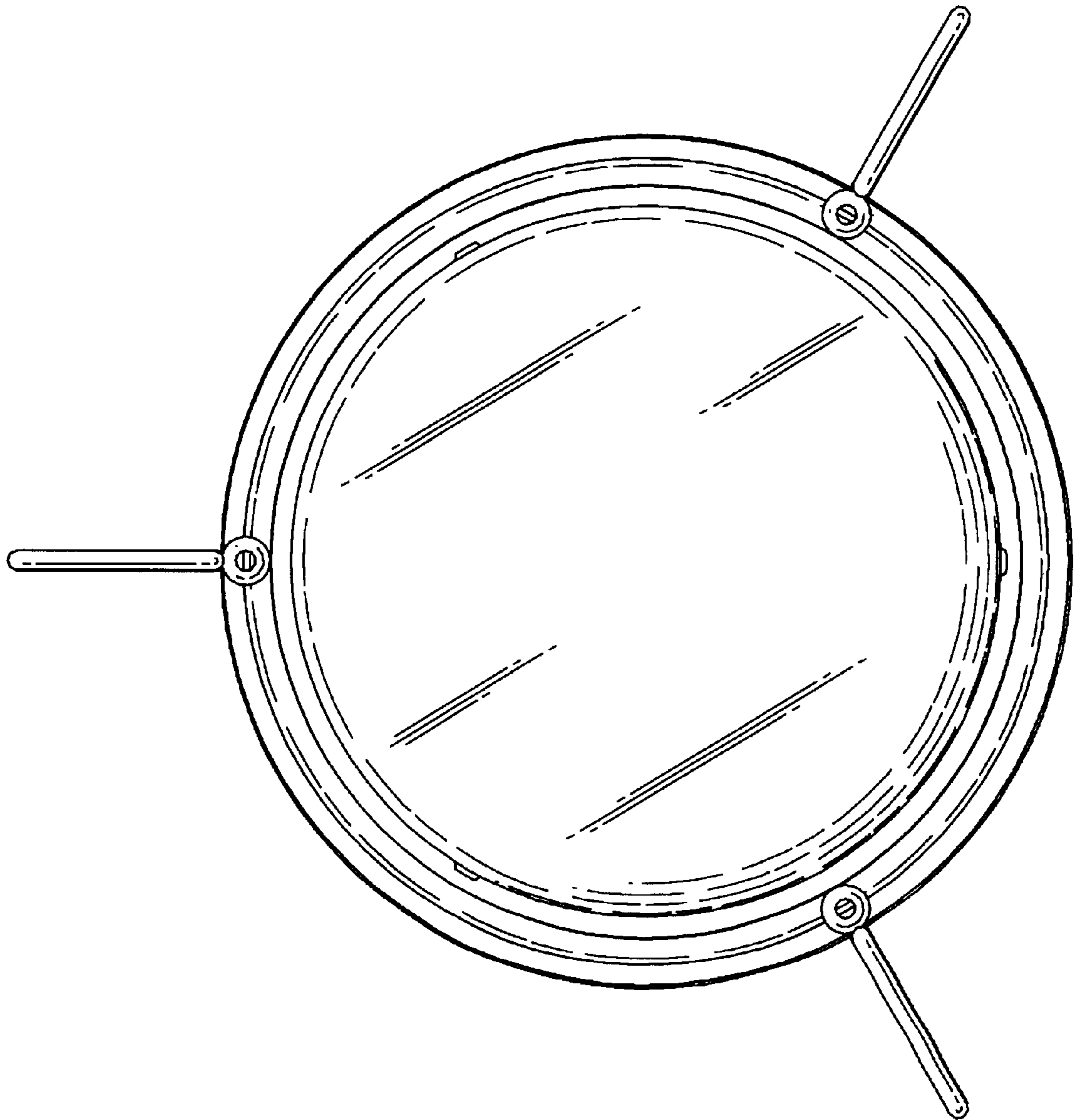

FIG. 6

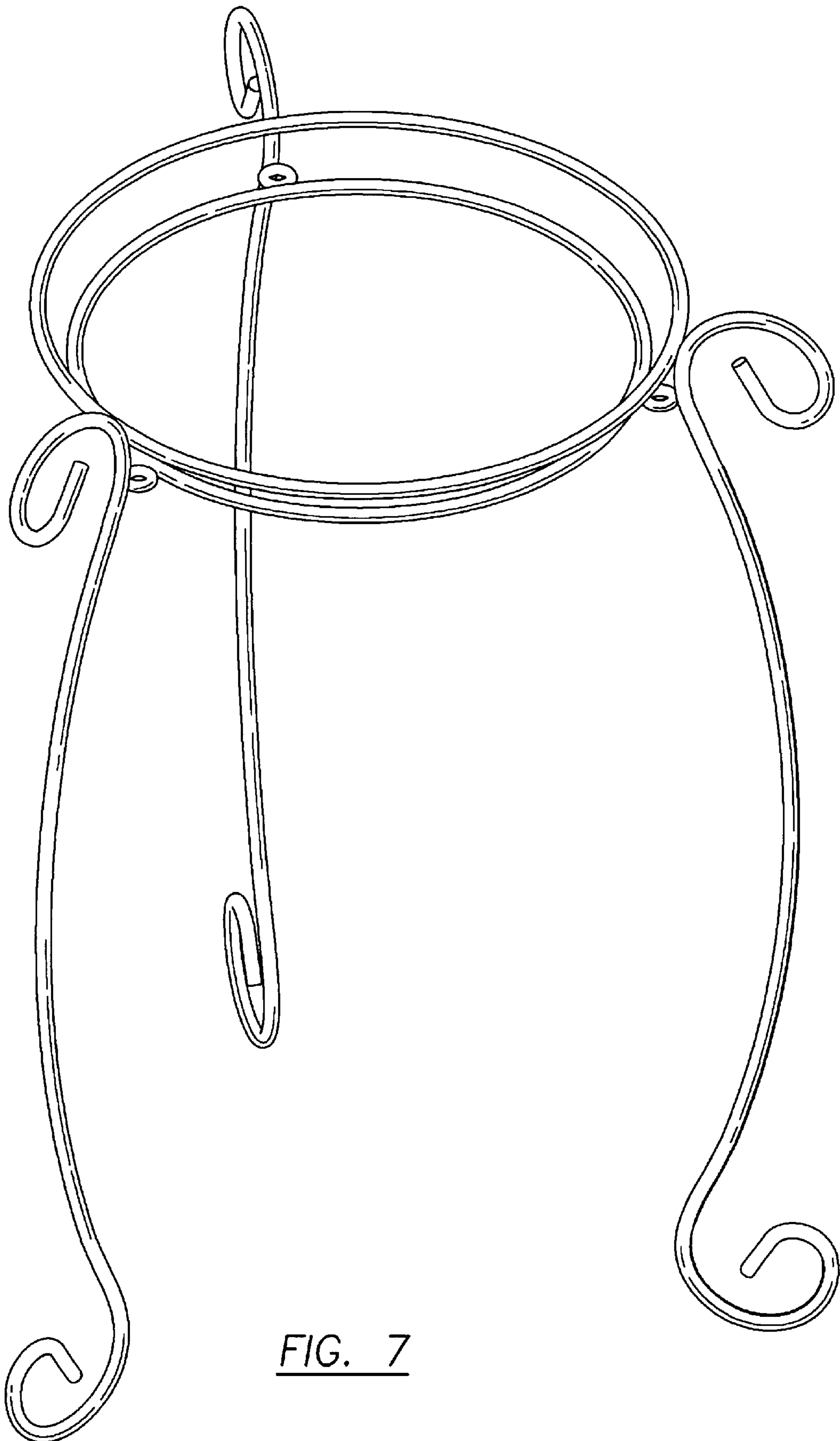

FIG. 7

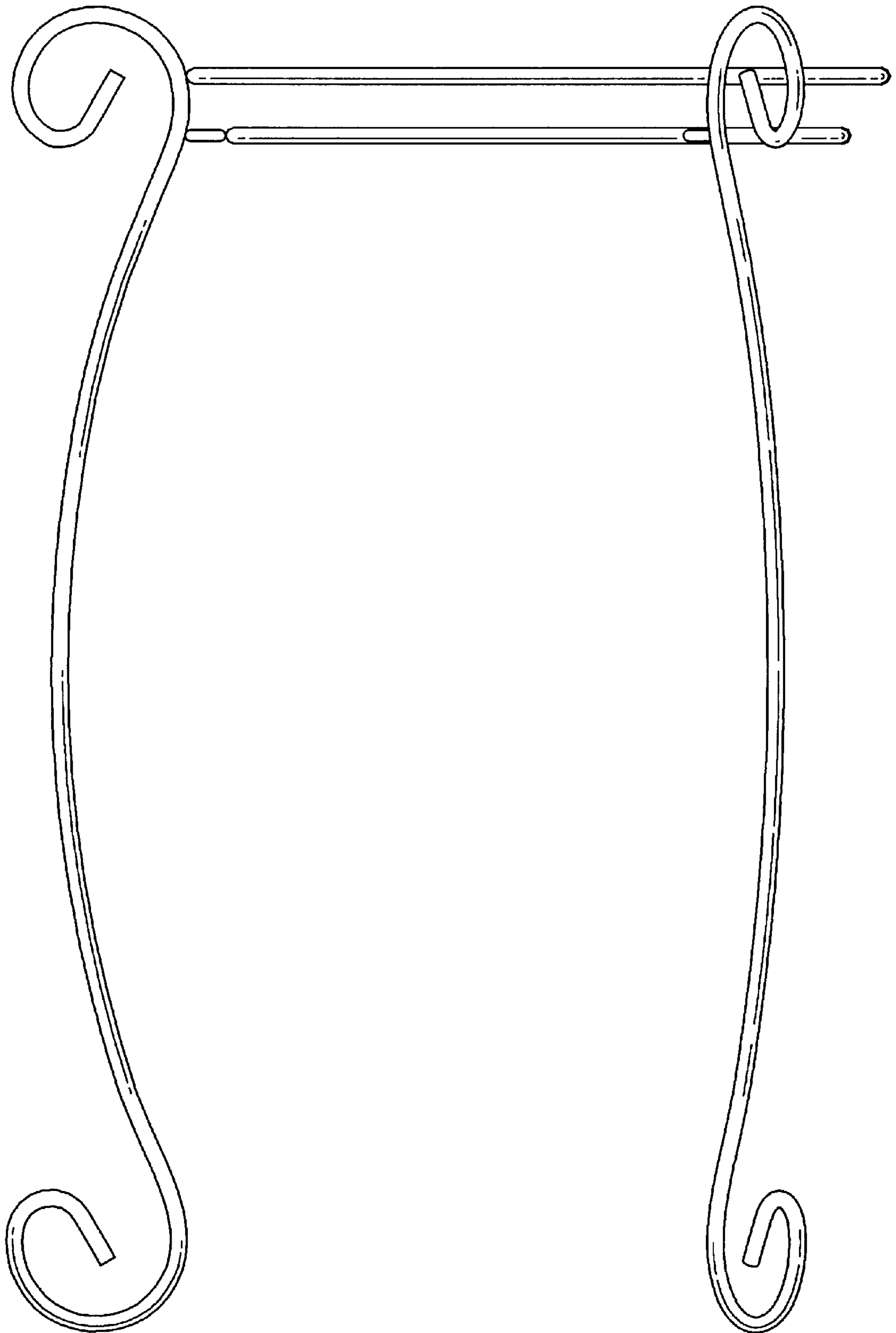

FIG. 8

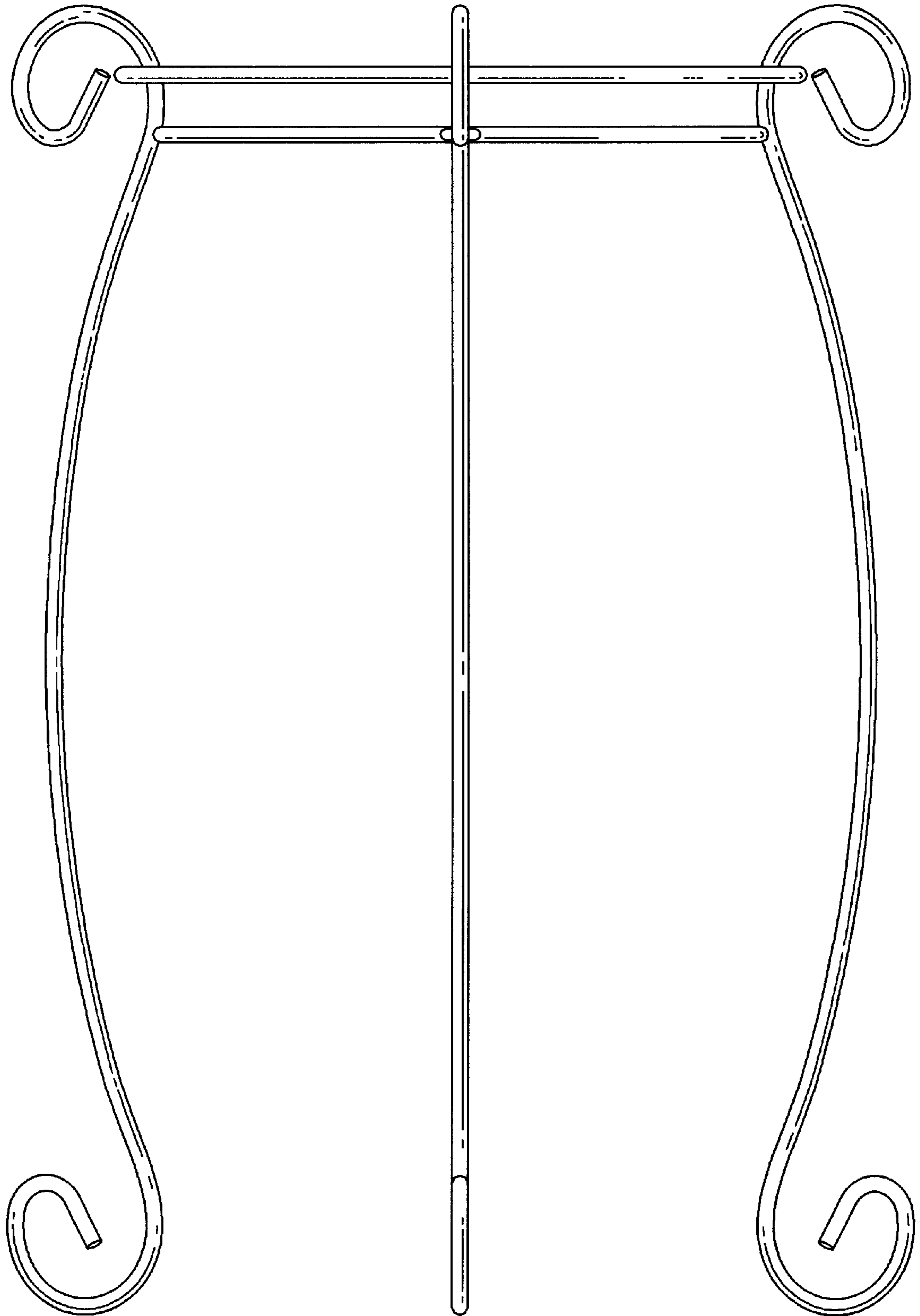

FIG. 9

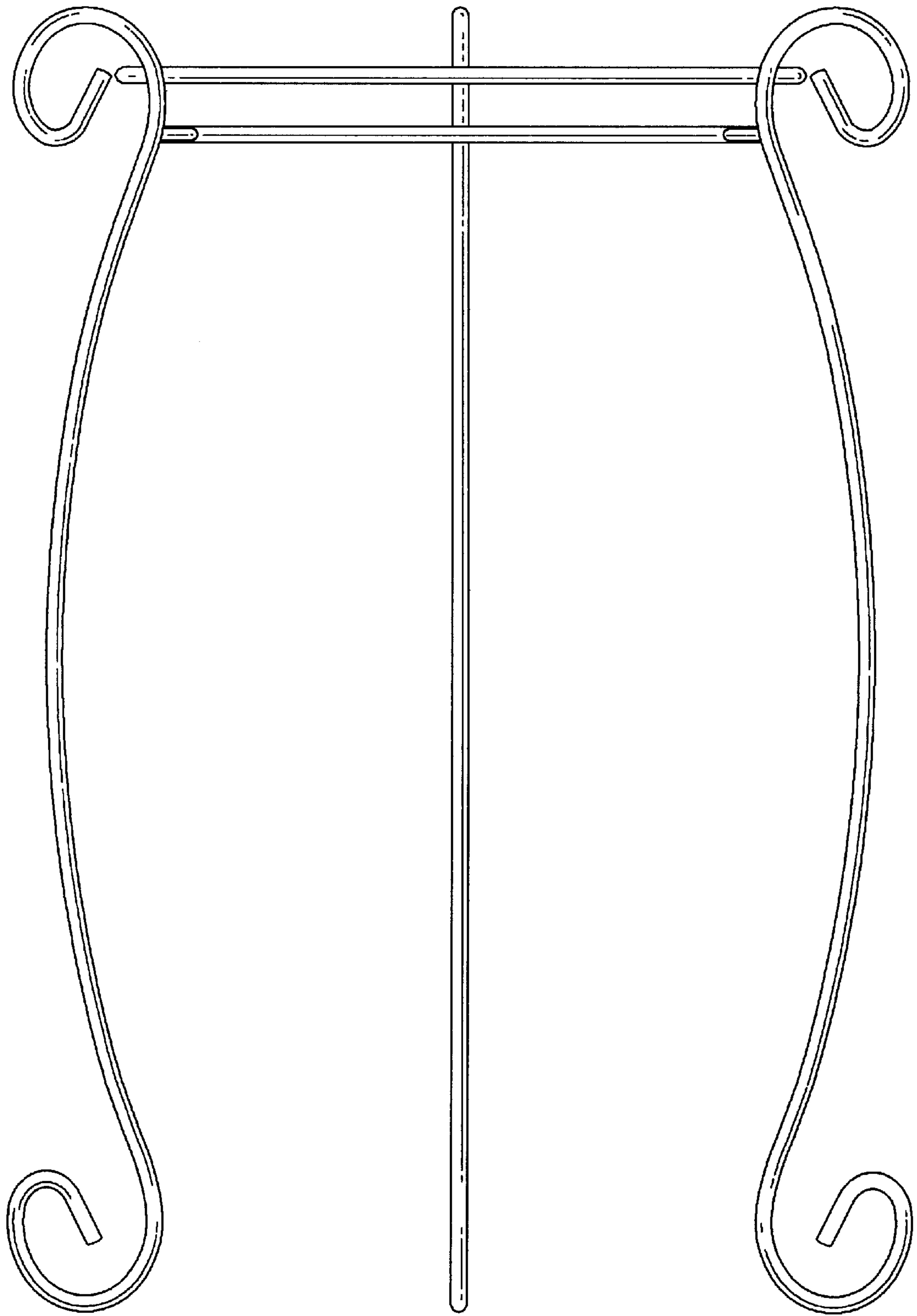

FIG. 10

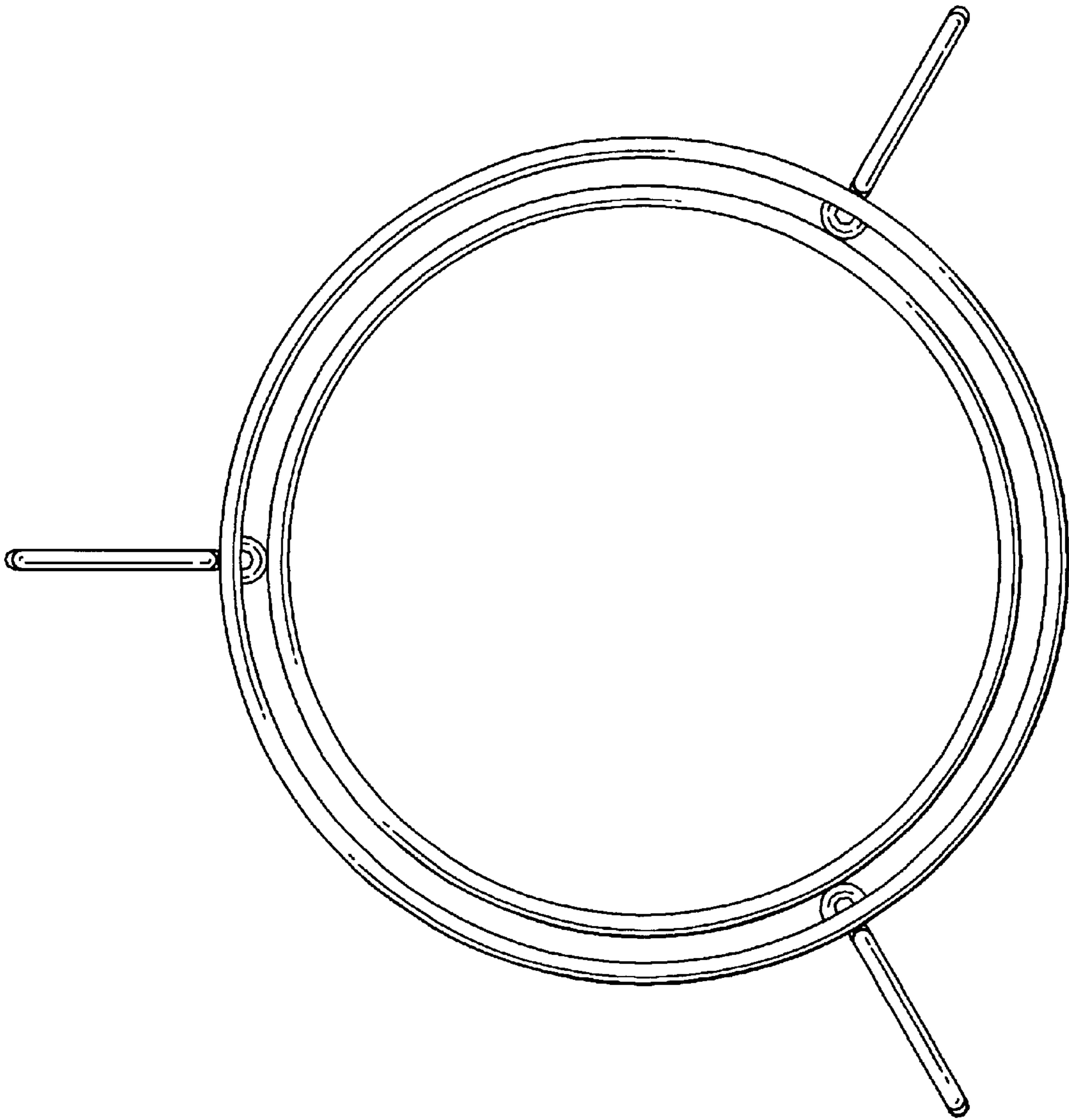

FIG. 11

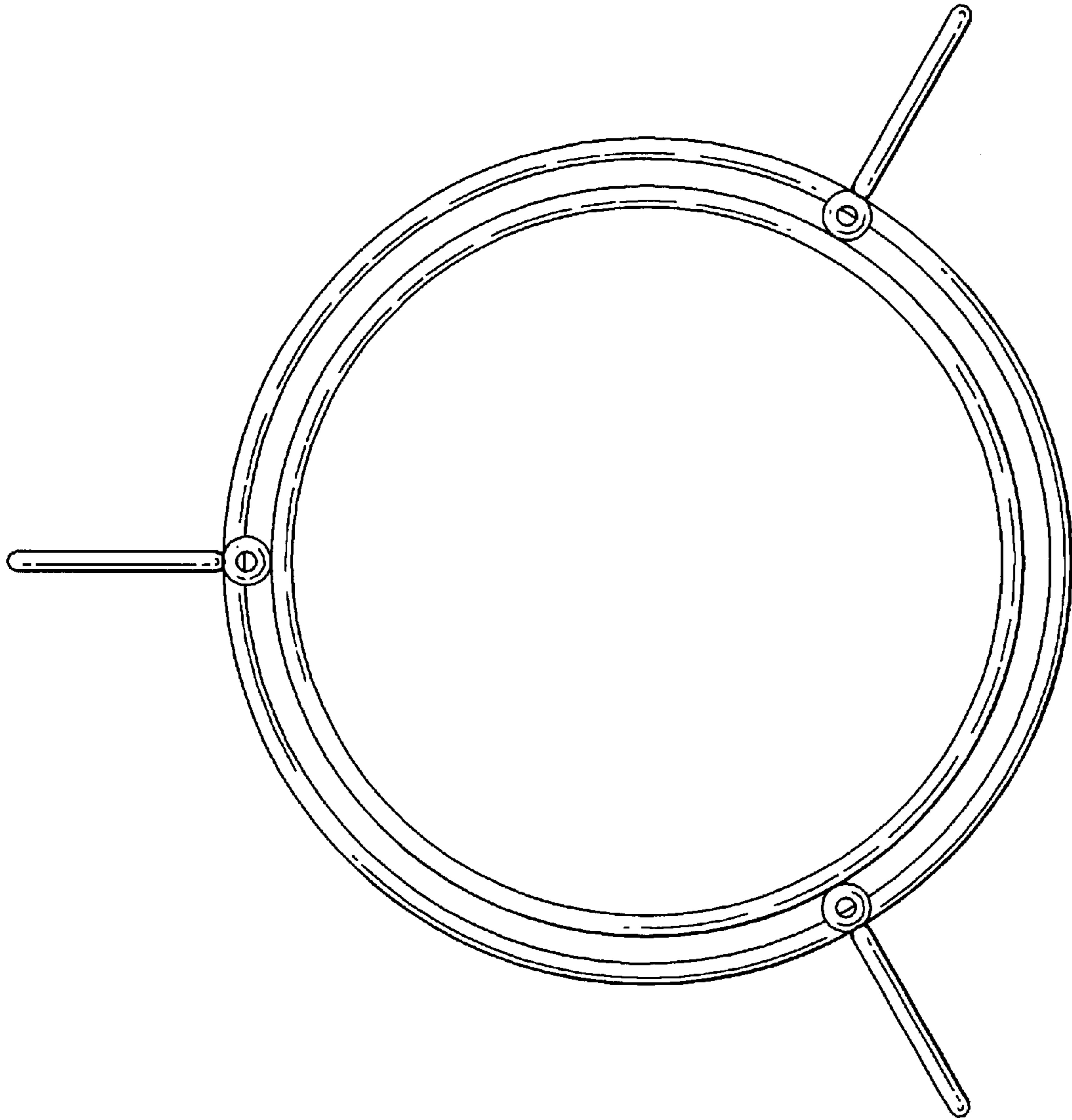

FIG. 12