



US00D478730S

(12) **United States Design Patent**
Goulet

(10) **Patent No.:** **US D478,730 S**

(45) **Date of Patent:** **** Aug. 26, 2003**

(54) **PAINT APPLICATOR HANDLE**

(75) **Inventor:** **Matthew G. Goulet, Milwaukee, WI (US)**

(73) **Assignee:** **Newell Operating Company, Freeport, IL (US)**

(**) **Term:** **14 Years**

(21) **Appl. No.:** **29/153,826**

(22) **Filed:** **Jan. 11, 2002**

(51) **LOC (7) Cl. 04-04**

(52) **U.S. Cl. D4/138**

(58) **Field of Search** D4/132, 135, 138, D4/199; 15/143.1, 159.1, 160, 168, 191.1, 192-193; 16/110.1

(56) **References Cited**

U.S. PATENT DOCUMENTS

375,773 A 1/1888 Rockwell

(List continued on next page.)

FOREIGN PATENT DOCUMENTS

BE 514702 7/1954

(List continued on next page.)

OTHER PUBLICATIONS

“One Coater Supreme—The Brush That’s Better At Both Ends!” EZ Paint, 1996, 1 page.

Primary Examiner—Alan P. Douglas

Assistant Examiner—Lavone D. Tabor

(74) *Attorney, Agent, or Firm*—Marshall, Gerstein & Borun

(57) **CLAIM**

The ornamental design for a paint applicator handle, as shown and described.

DESCRIPTION

FIG. 1 is a perspective view of a paint applicator handle of the present invention;

FIG. 2 is a top plan view thereof, the bottom plan view being a mirror image of the top plan view;

FIG. 3 is a rear elevational view thereof;

FIG. 4 is a front elevational view thereof;

FIG. 5 is a left end elevational view thereof;

FIG. 6 is a perspective view of a first alternative embodiment of the paint applicator handle of FIG. 1;

FIG. 7 is a top plan view thereof, the bottom plan view being a mirror image of the top plan view;

FIG. 8 is a rear elevational view thereof;

FIG. 9 is a front elevational view thereof;

FIG. 10 is a left end elevational view thereof;

FIG. 11 is a perspective view of a second alternative embodiment of the paint applicator handle of FIG. 1;

FIG. 12 is a top plan view thereof, the bottom plan view being a mirror image of the top plan view;

FIG. 13 is a rear elevational view thereof;

FIG. 14 is a front elevational view thereof;

FIG. 15 is a left end elevational view thereof;

FIG. 16 is a perspective view of a third alternative embodiment of the paint applicator handle of FIG. 1;

FIG. 17 is a top plan view thereof, the bottom plan view being a mirror image of the top plan view;

FIG. 18 is a rear elevational view thereof, the front elevational view being a mirror image of the rear elevational view;

FIG. 19 is a perspective view of the fourth alternative embodiment of the paint applicator handle of FIG. 1;

FIG. 20 is a top plan view thereof, the bottom plan view being a mirror image of the top plan view;

FIG. 21 is a rear elevational view thereof, the front elevational view being a mirror image of the rear elevational view;

FIG. 22 is a perspective view of a fifth alternative embodiment of the paint applicator handle of FIG. 1;

FIG. 23 is a left end elevational view thereof;

FIG. 24 is a top plan view thereof, the bottom plan view being a mirror image of the top; and,

FIG. 25 is a rear elevational view thereof, the front elevational view being a mirror image of the rear.

The ornamental design which is claimed is shown in solid lines in the drawings. The broken lines in the drawings are for illustrative purposes only and form no part of the claimed design.

1 Claim, 10 Drawing Sheets

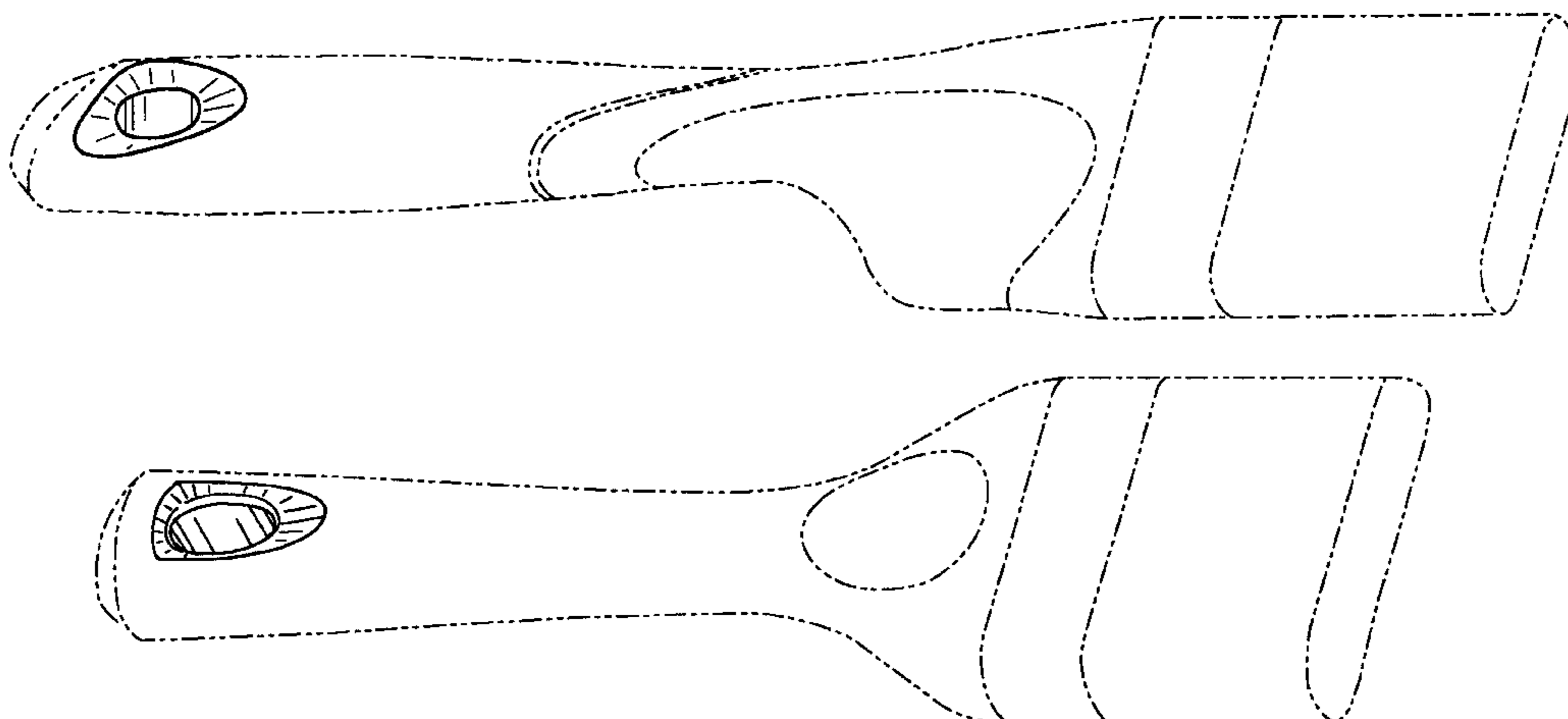

US D478,730 S

Page 2

U.S. PATENT DOCUMENTS

376,540	A	1/1888	McQuide	
412,479	A	10/1889	Davis	
D30,616	S	4/1899	Bentzinger	
D31,122	S	7/1899	Kelly	
673,506	A	5/1901	Pitts	
1,054,709	A	3/1913	Munro	
1,687,335	A	10/1928	Jackline	
1,826,165	A	10/1931	Cartwright	
1,838,958	A	12/1931	Page	
1,888,930	A	11/1932	McMillan	
2,236,034	A	3/1941	Luce et al.	
2,237,969	A	4/1941	Olsen	
2,263,885	A	11/1941	McGauley	
2,304,319	A	12/1942	Saltzman	
2,426,315	A	8/1947	Marick	
D167,775	S	9/1952	Schmidt	
2,664,582	A	1/1954	Kammann	
2,914,785	A	12/1959	Ela	
3,023,439	A	3/1962	Danley	
3,067,446	A	12/1962	McGauley	
3,153,801	A	10/1964	Weiss et al.	
D211,446	S	6/1968	Hange	
D216,247	S	12/1969	McGuire	
D223,017	S	2/1972	Pharris	
3,797,062	A	* 3/1974	LoCiero	
3,819,779	A	6/1974	Pharris et al.	
D240,678	S	7/1976	Herig	
4,454,623	A	6/1984	O'Halloran	
4,481,689	A	11/1984	Westmoreland	
4,490,875	A	1/1985	Grunz	
4,495,669	A	1/1985	Hooper	
4,590,637	A	* 5/1986	Marino	15/160
D292,348	S	10/1987	Roberts et al.	
4,751,762	A	6/1988	Meimeteeas	
4,847,939	A	7/1989	Derencsenyi et al.	

D309,379	S	7/1990	Dawes	
D311,455	S	10/1990	Snipes	
5,155,878	A	10/1992	Dellis	
D333,217	S	2/1993	Gingras	
D347,327	S	5/1994	Ricciarelli et al.	
5,339,482	A	8/1994	Desimone et al.	
5,343,585	A	9/1994	Howell	
5,390,572	A	2/1995	Gakhar et al.	
5,446,941	A	9/1995	Kelsay	
5,465,449	A	11/1995	Lewkowicz	
D367,963	S	3/1996	Mayer	
5,556,092	A	9/1996	Theken	
5,615,445	A	4/1997	Kelsay et al.	
5,692,265	A	12/1997	Dalury	
5,761,759	A	6/1998	Leversby et al.	
5,761,767	A	6/1998	Barton	
5,829,099	A	11/1998	Kopelman et al.	
5,850,663	A	12/1998	Hardy et al.	
5,873,148	A	2/1999	Arnold	
5,920,943	A	7/1999	Barker	
6,145,151	A	11/2000	Herron et al.	
D439,417	S	3/2001	Woodnorth et al.	
2001/0020315	A1	* 9/2001	Lallenment et al.	15/192

FOREIGN PATENT DOCUMENTS

DE	2 256 856	5/1974	
DE	27 35 542	2/1979	
DE	4331222	* 8/1994 A46B/5/02
EP	0679351	* 11/1995 A46B/7/04
GB	351858	7/1931	
GB	844124	8/1960	
GB	2050156	1/1981	
JP	6-226193	8/1994	
JP	6-85778	12/1994	
WO	WO 93/16846	9/1993	

* cited by examiner

FIG. 1

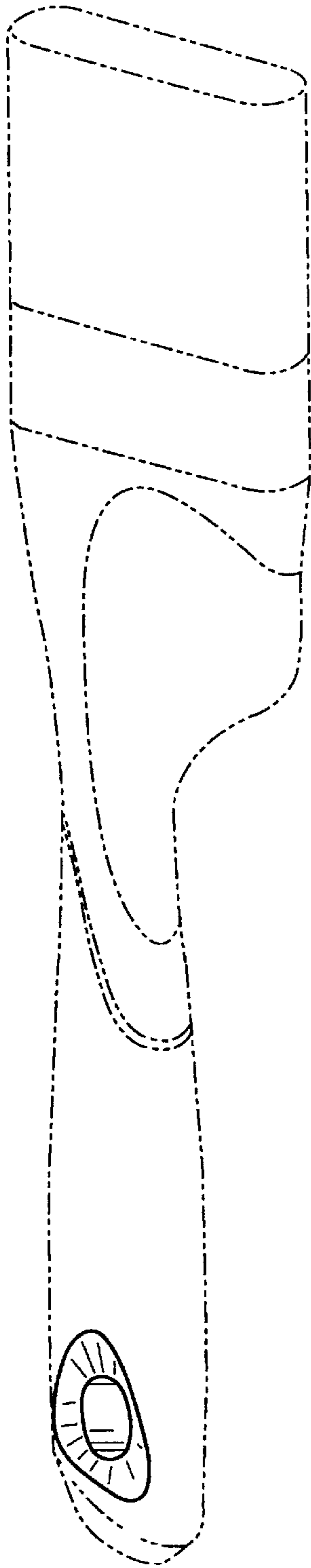

FIG. 2

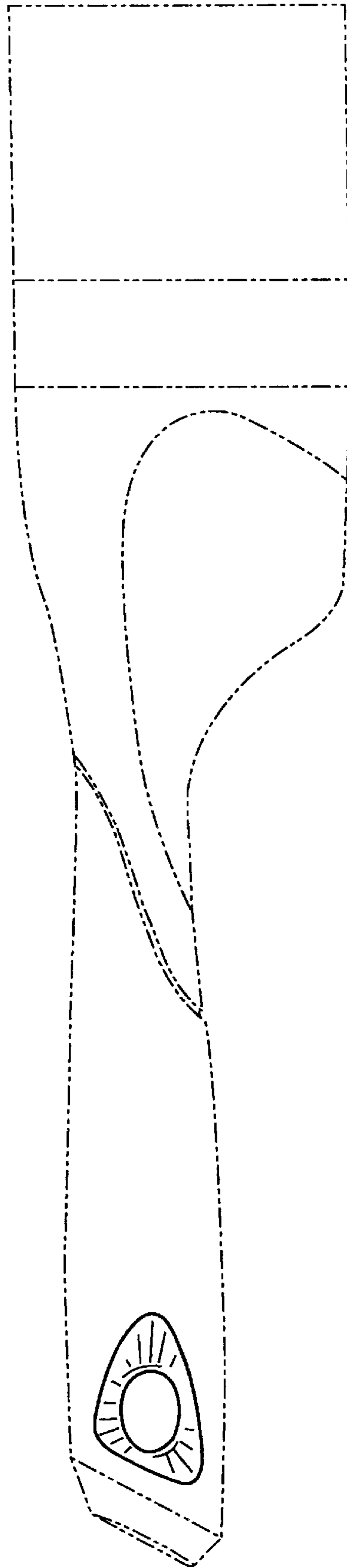

FIG. 3

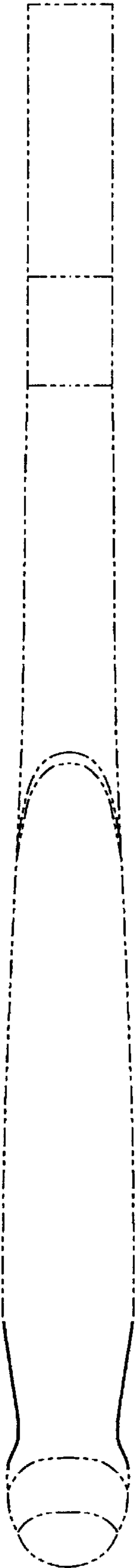

FIG. 4

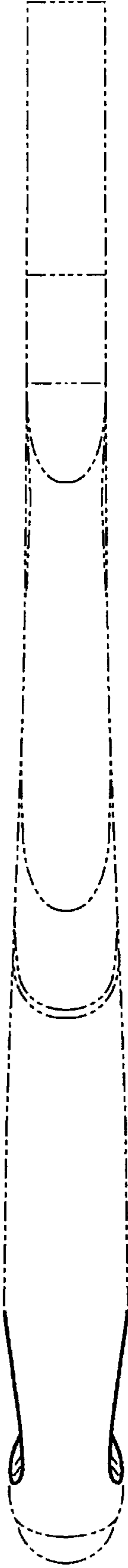

FIG. 5

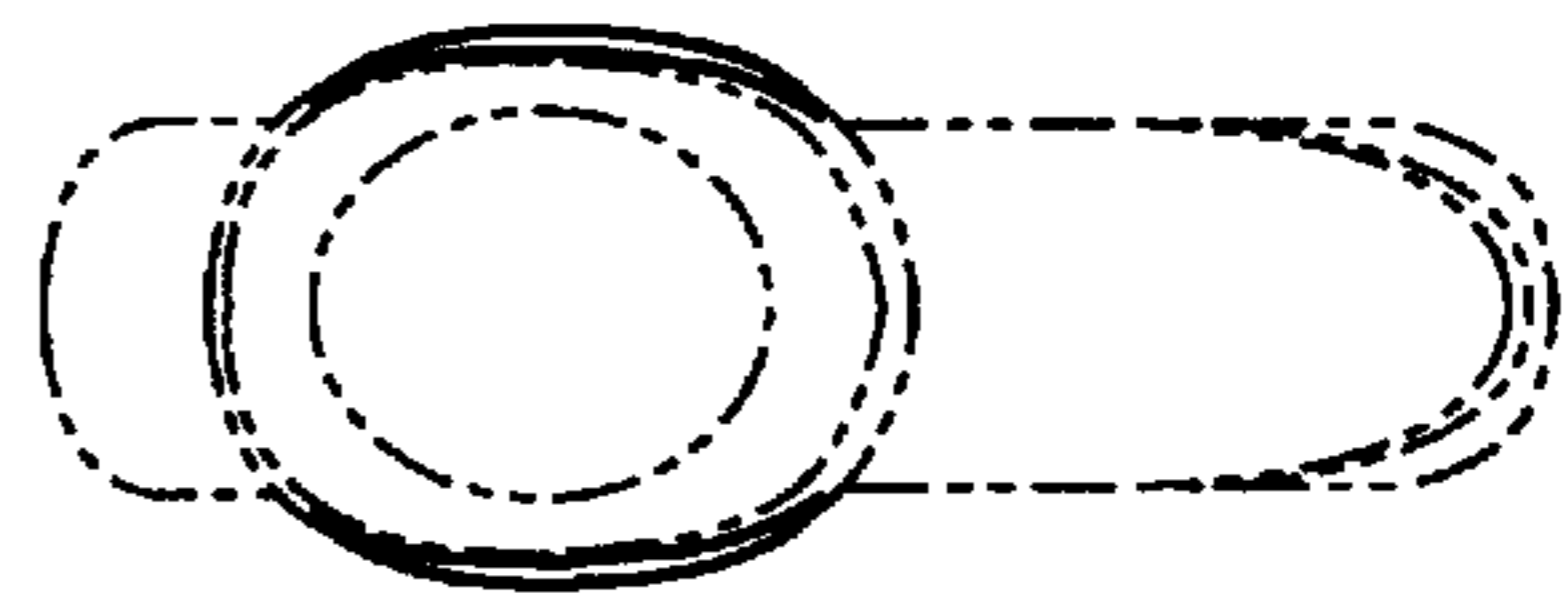

FIG. 6

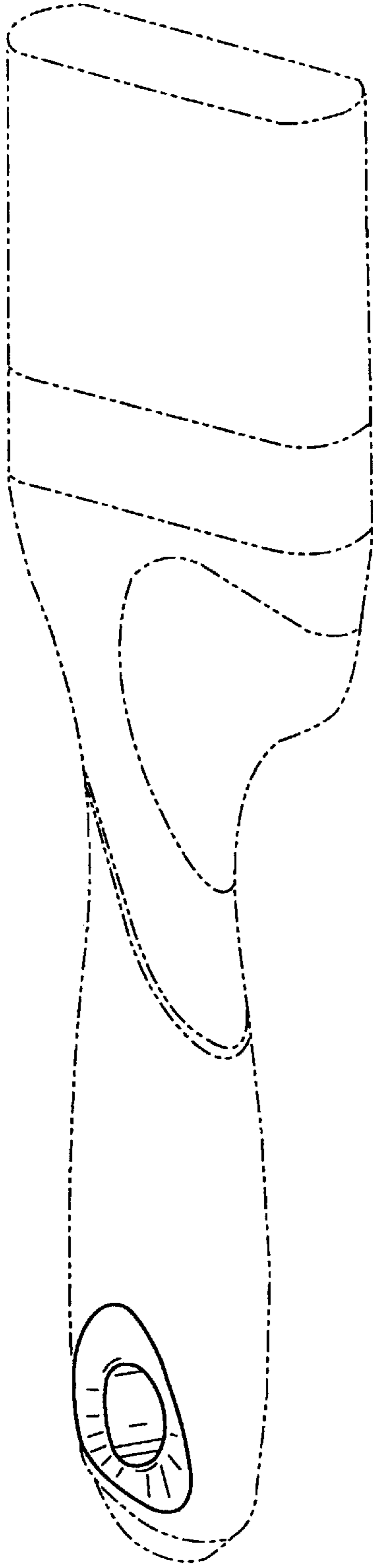

FIG. 7

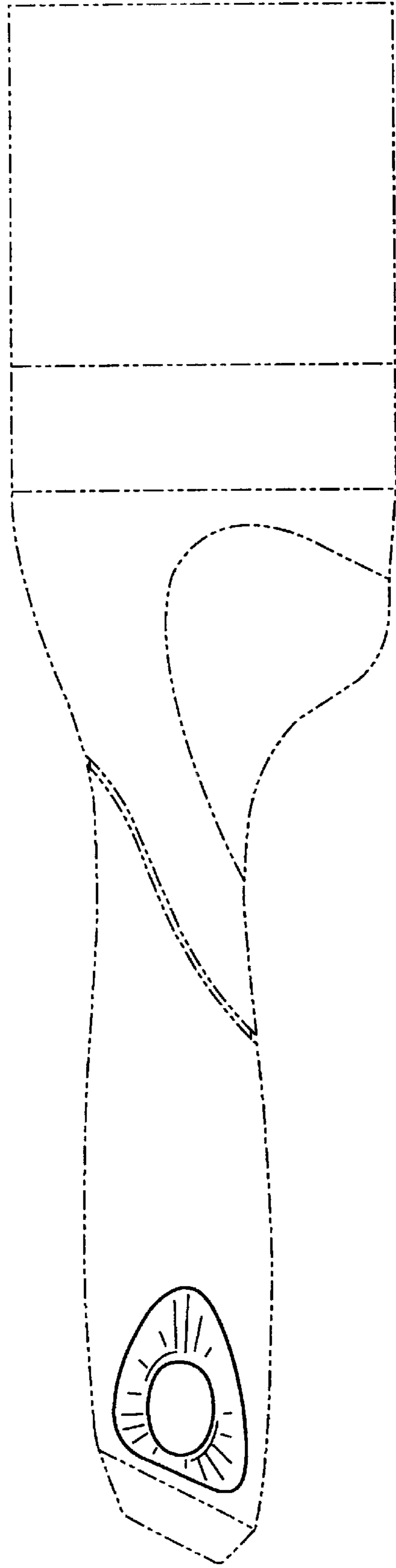

FIG. 8

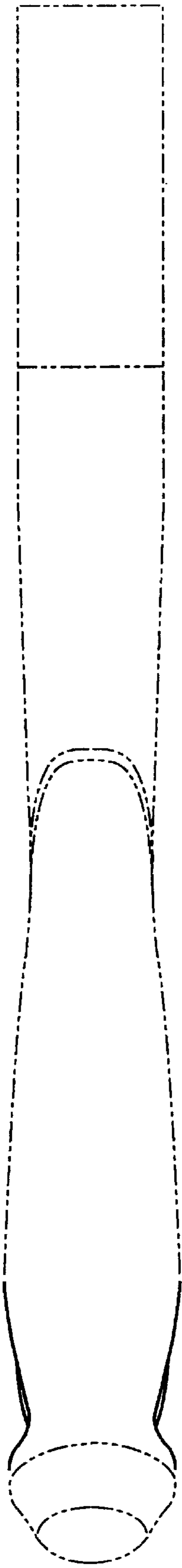

FIG. 9

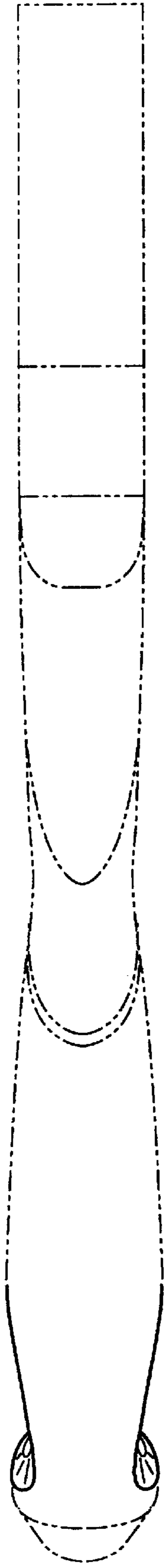

FIG. 10

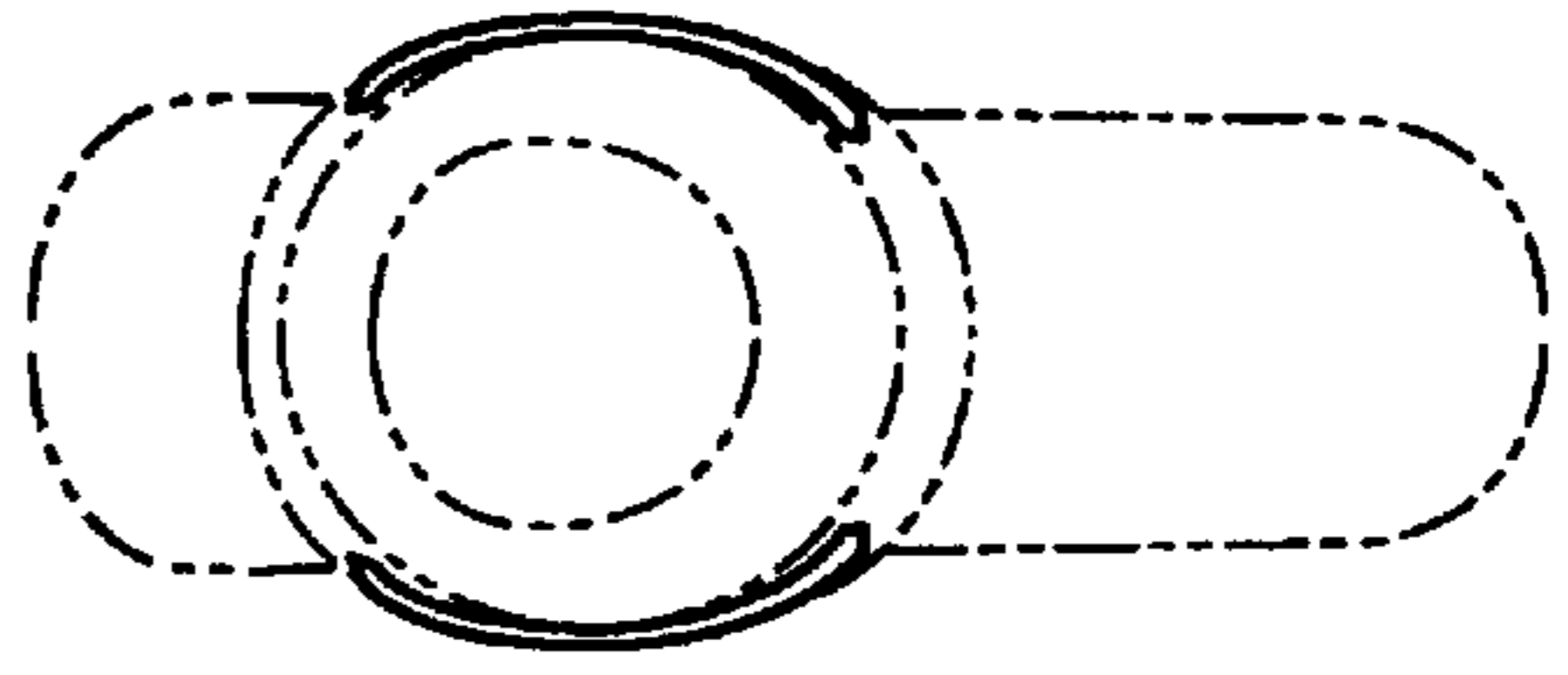

FIG. 11



FIG. 12

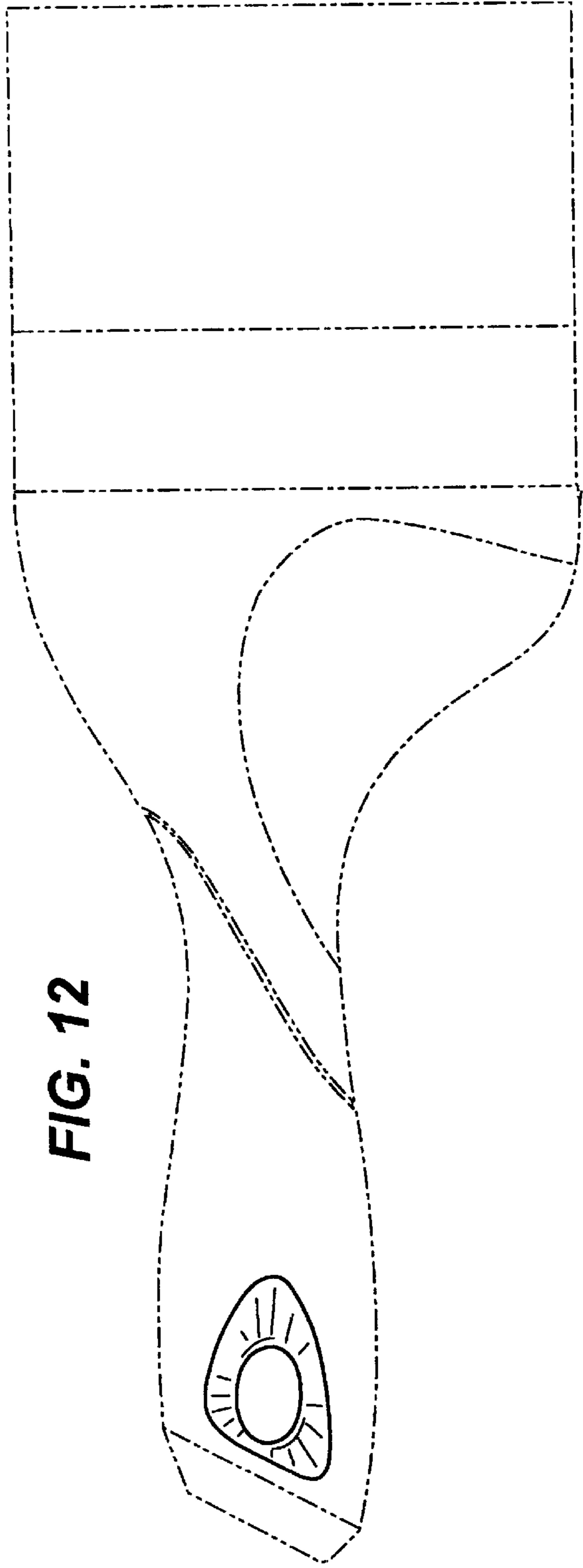

FIG. 13

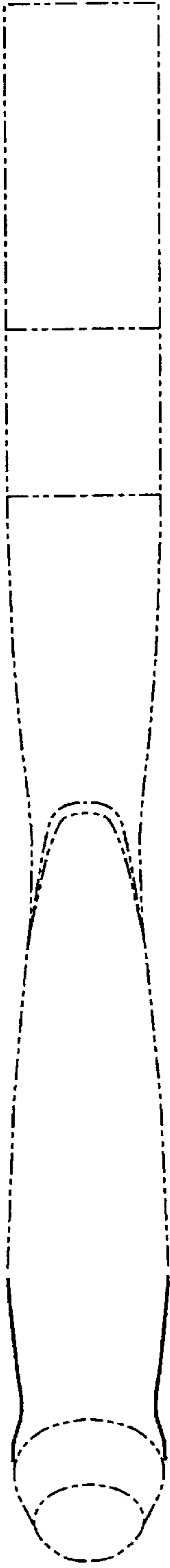

FIG. 14

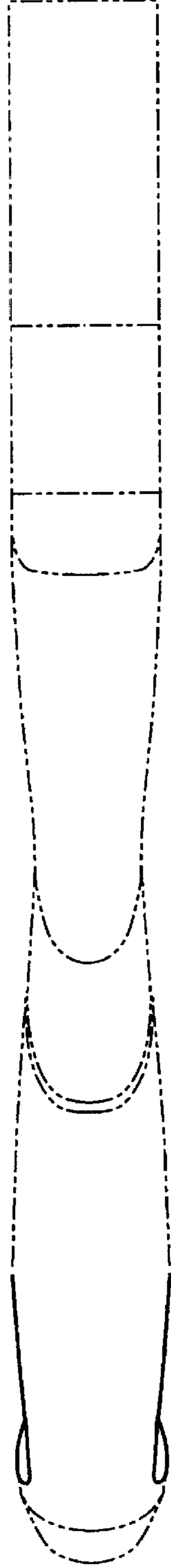

FIG. 15

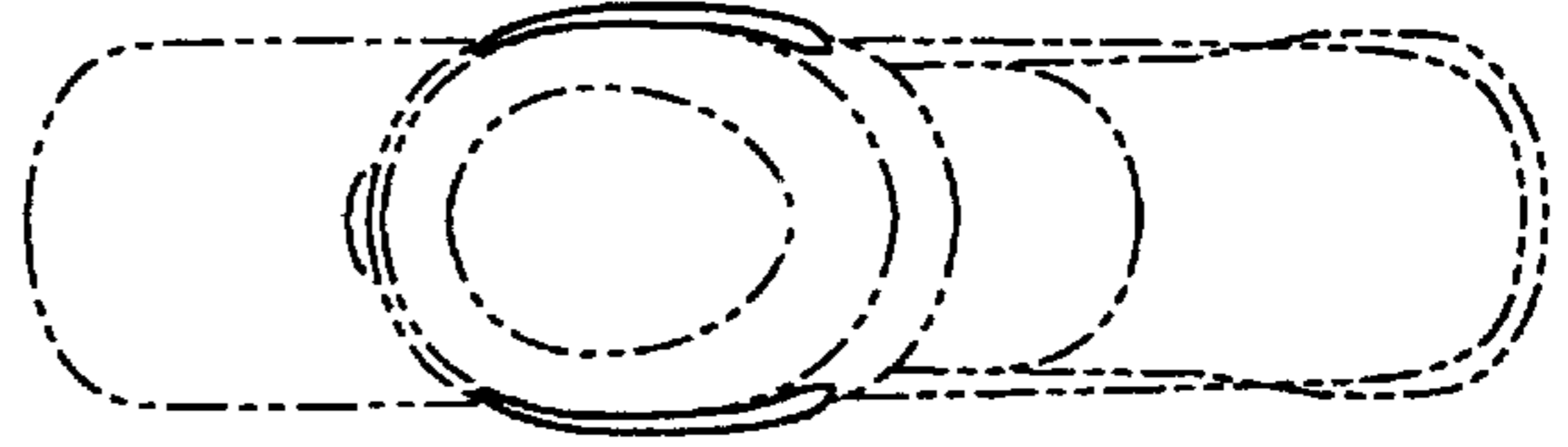

FIG. 16

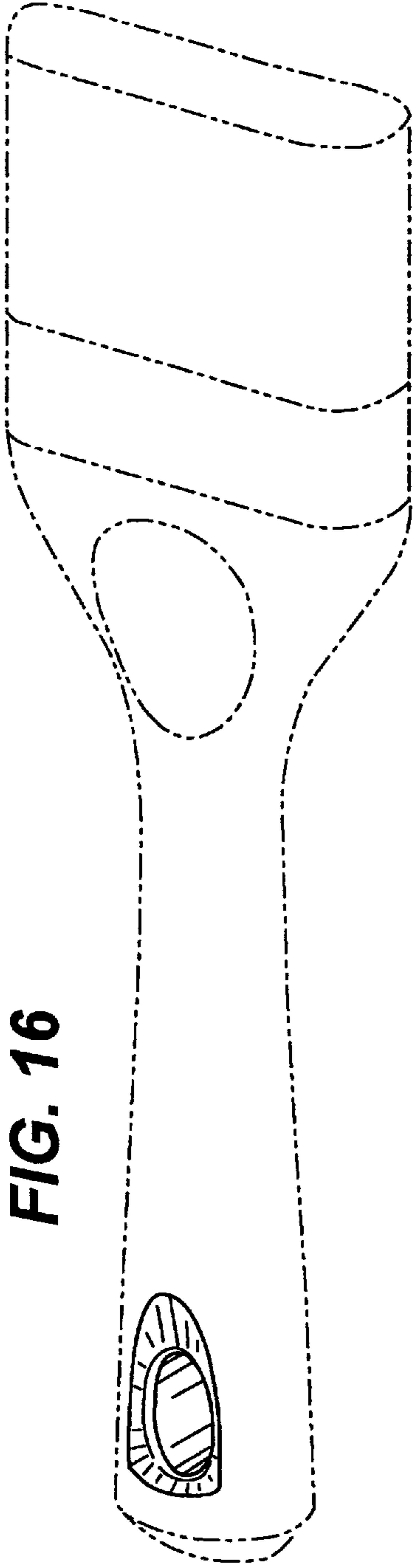

FIG. 17

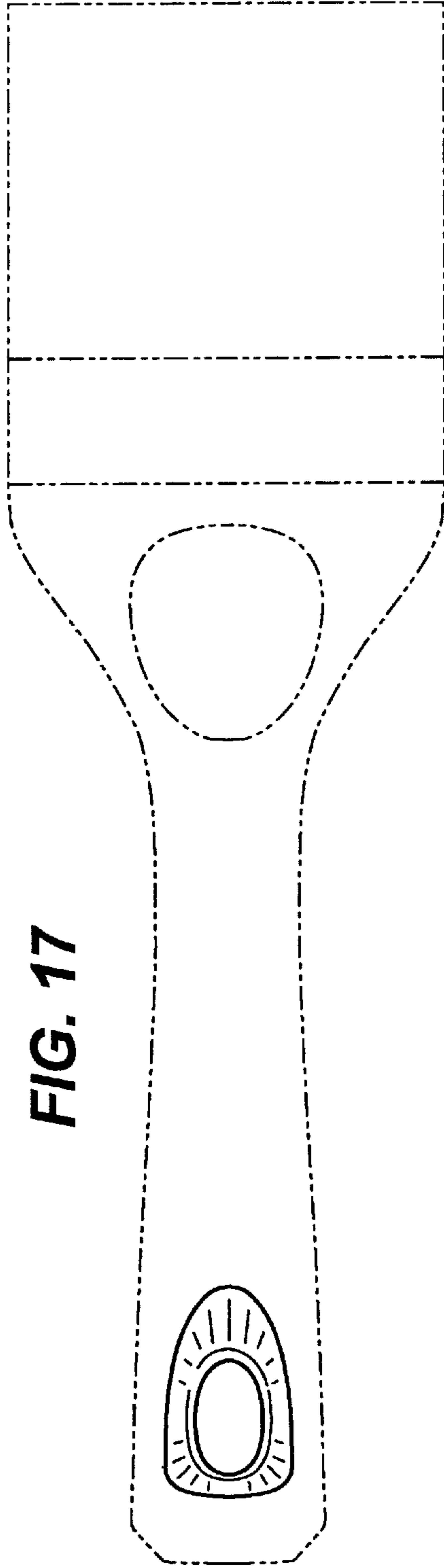
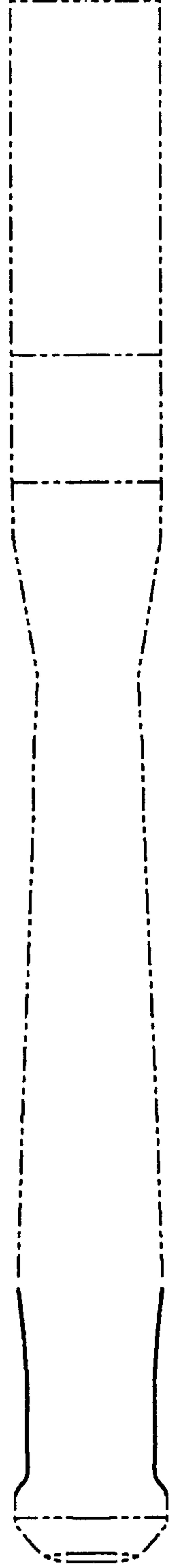

FIG. 18



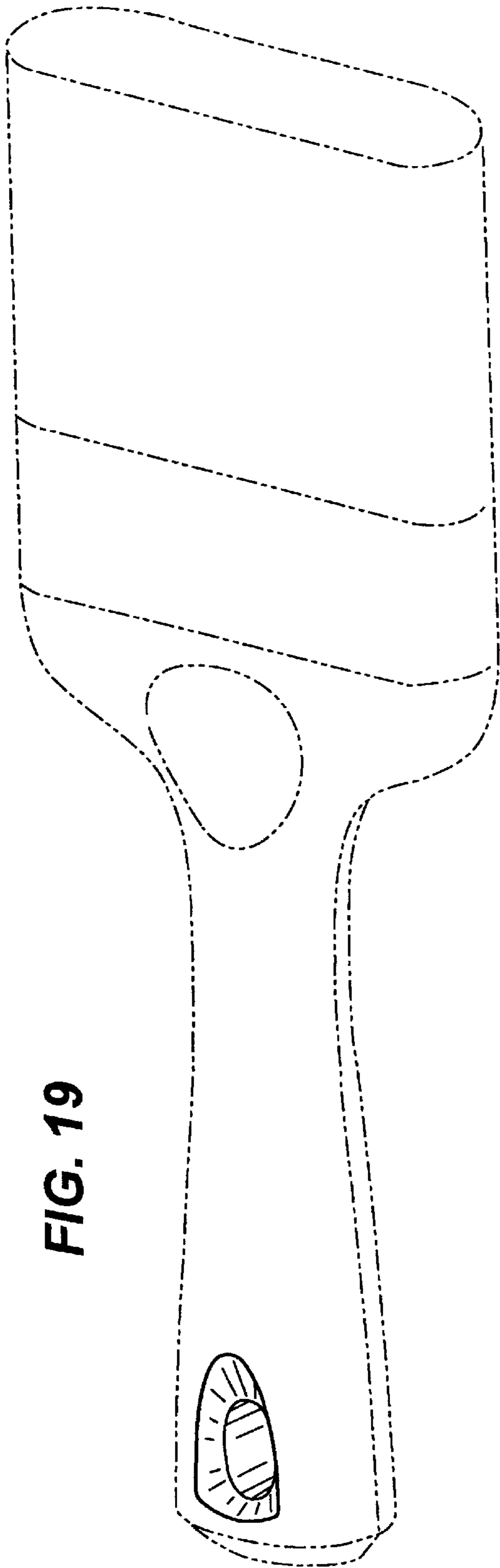

FIG. 19

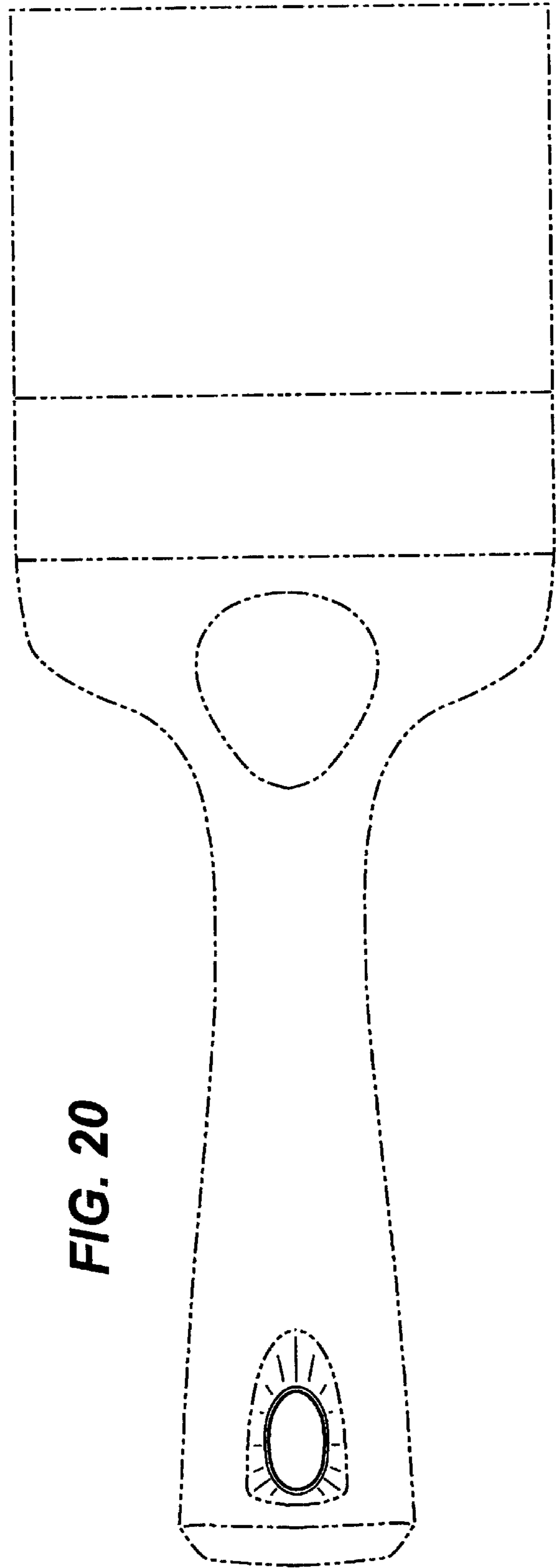
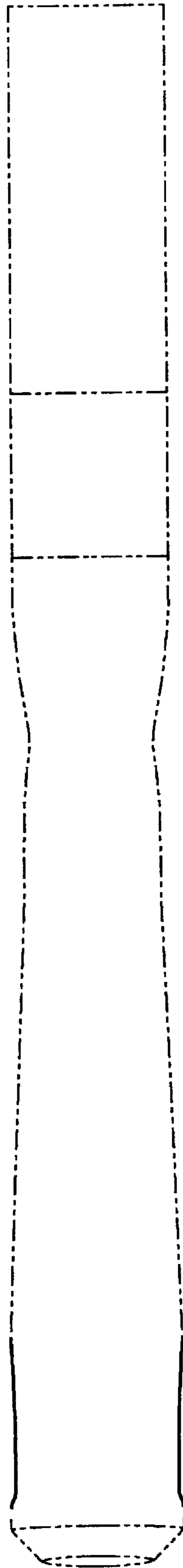

FIG. 20

FIG. 21



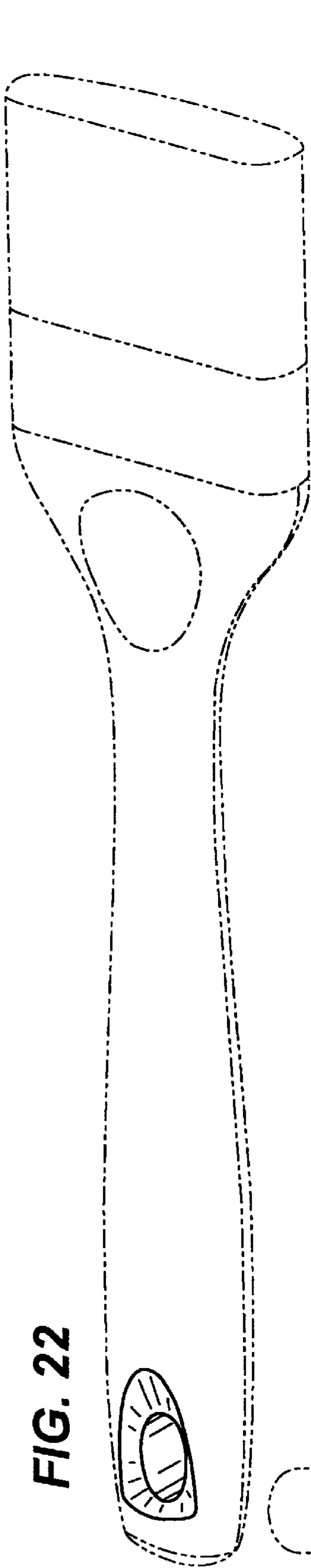

FIG. 22

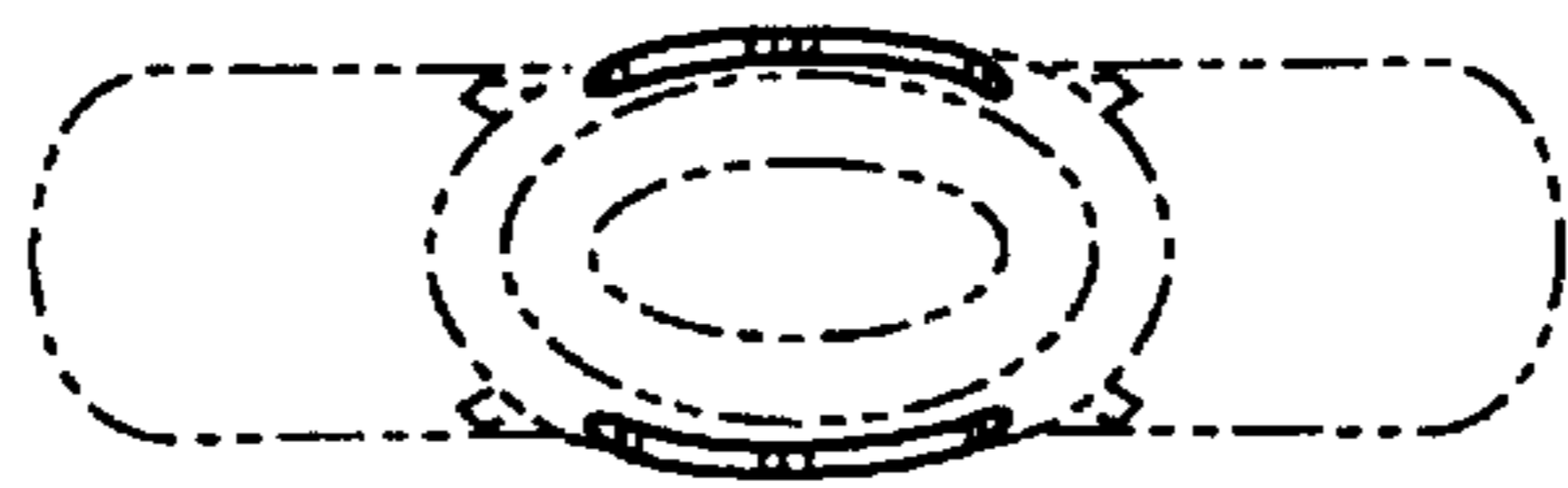

FIG. 23

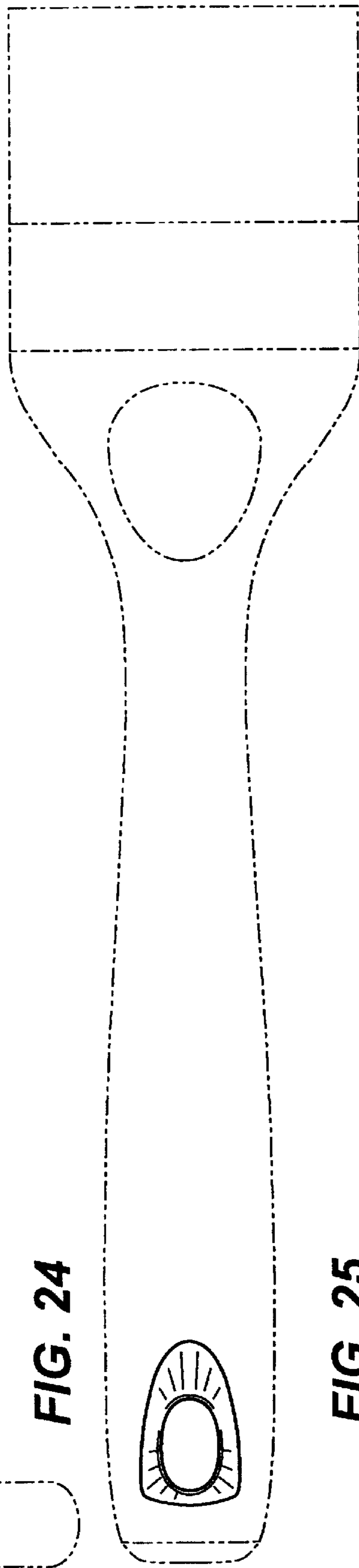

FIG. 24

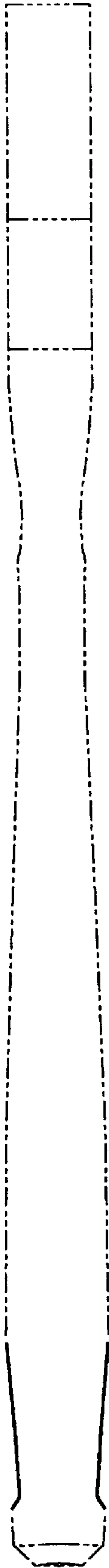

FIG. 25