



US00D478504S

(12) **United States Design Patent**
Crozet et al.

(10) **Patent No.:** **US D478,504 S**

(45) **Date of Patent:** **** Aug. 19, 2003**

(54) **POUCH WITH PRESS TAP**

D465,726 S * 11/2002 Tet D9/305
D470,758 S * 2/2003 Bakersmith D9/305

(75) Inventors: **Yvon Loic Crozet**, Brussels (BE);
Patrick Jean-Francois Etesse, Brussels
(BE)

* cited by examiner

(73) Assignee: **The Procter & Gamble Company**,
Cincinnati, OH (US)

Primary Examiner—Paula A. Mortimer
(74) *Attorney, Agent, or Firm*—Armina E. Matthews; Kim
W. Zerby; Steven W. Miller

(**) Term: **14 Years**

(57) **CLAIM**

(21) Appl. No.: **29/163,863**

The ornamental design for a pouch with press tap, as shown
and described.

(22) Filed: **Jul. 12, 2002**

DESCRIPTION

(51) **LOC (7) Cl.** **09-07**

(52) **U.S. Cl.** **D9/305**

(58) **Field of Search** D9/300, 302, 305,
D9/306, 456, 440, 442; 222/81, 92, 104,
105, 107, 119, 120, 541.1, 541.5, 121,
494; 383/200, 207, 209, 121, 120, 906,
104; D24/118, 129

FIG. 1 is a perspective view from front, above and right side;
FIG. 2 is a perspective view from front;
FIG. 3 is a perspective view from rear;
FIG. 4 is a perspective view from right side;
FIG. 5 is a perspective view from left side;
FIG. 6 is a perspective view from above;
FIG. 7 is a perspective view from below;
FIG. 8 is a perspective view from front, above and right side
of alternative;

(56) **References Cited**

U.S. PATENT DOCUMENTS

D243,121 S * 1/1977 Ralston, Jr. et al. D24/118
D291,491 S * 8/1987 Larkin D24/118
D304,546 S * 11/1989 Cattach D9/305
5,307,955 A * 5/1994 Viegas 222/107
D413,258 S * 8/1999 Voller D9/305
D425,786 S * 5/2000 Voller D9/305
6,105,821 A * 8/2000 Christine et al. 222/105
D451,793 S * 12/2001 Berman D9/305

FIG. 9 is a perspective view from front of alternative;
FIG. 10 is a perspective view from rear of alternative;
FIG. 11 is a perspective view from right side of alternative;
FIG. 12 is a perspective view from left side of alternative;
FIG. 13 is a perspective view from above of alternative; and,
FIG. 14 is a perspective view from below of alternative.
The broken lines in FIGS. 1,2,3,8,9,10 are for illustrative
purposes only and forms no part of the claimed design.

1 Claim, 10 Drawing Sheets

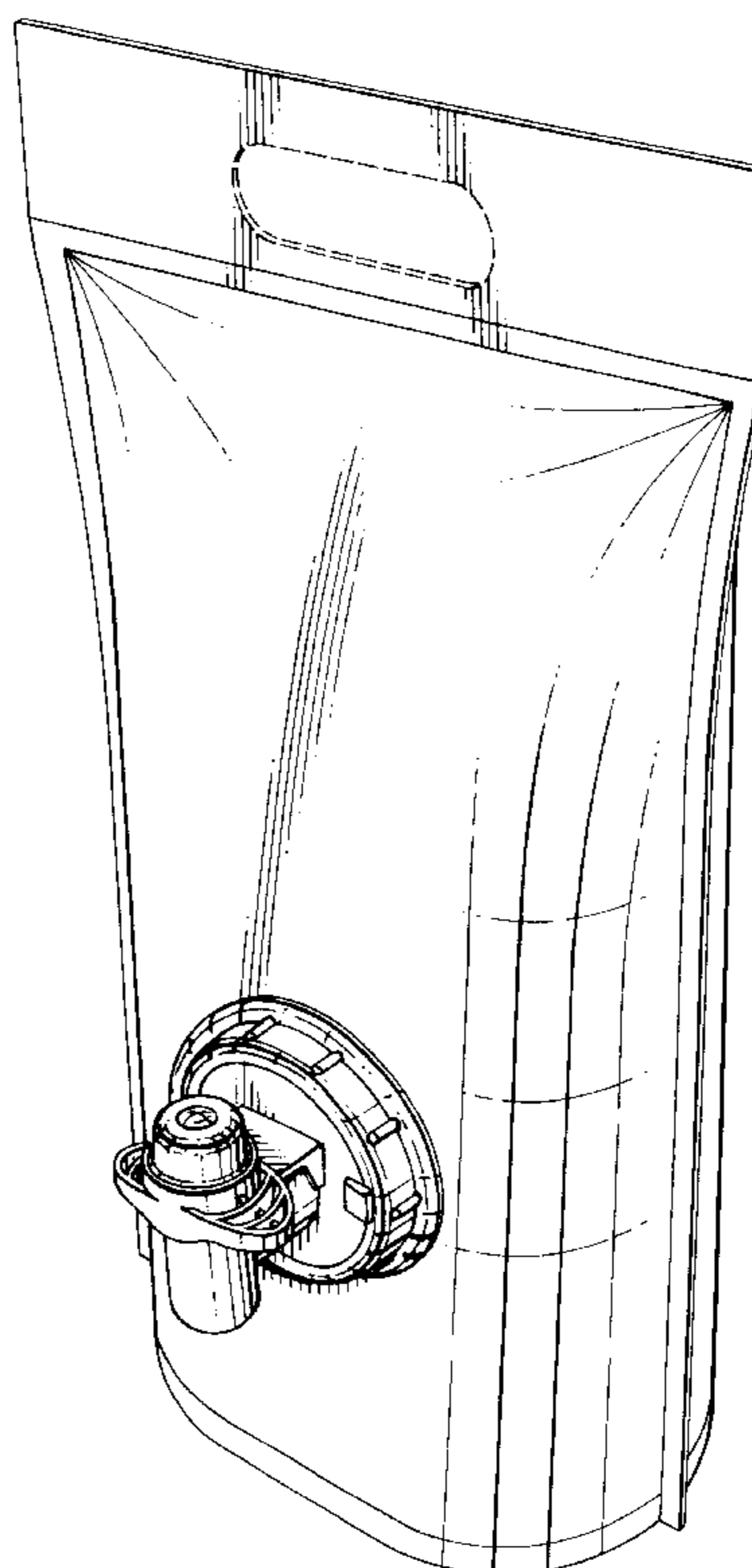
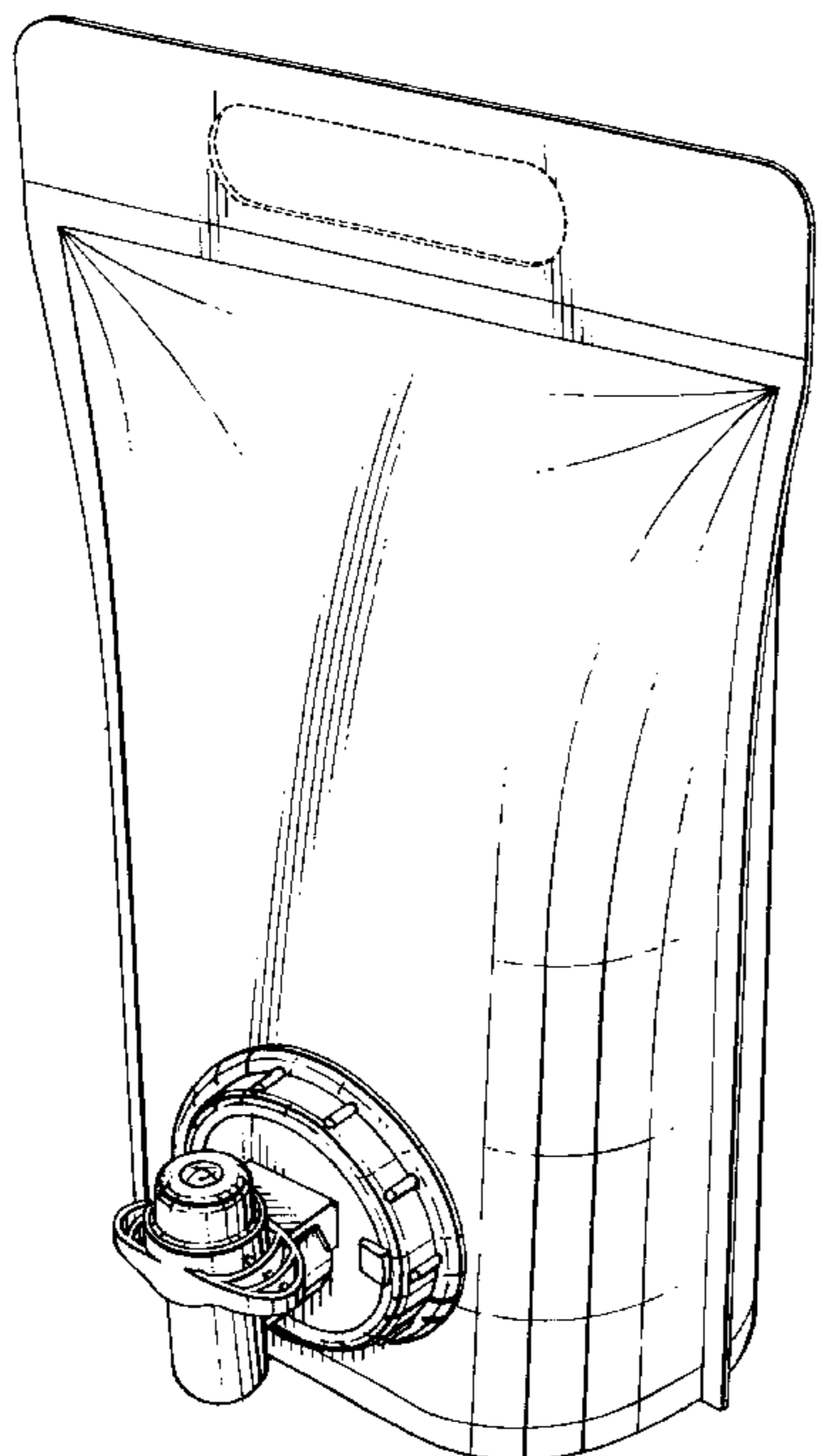

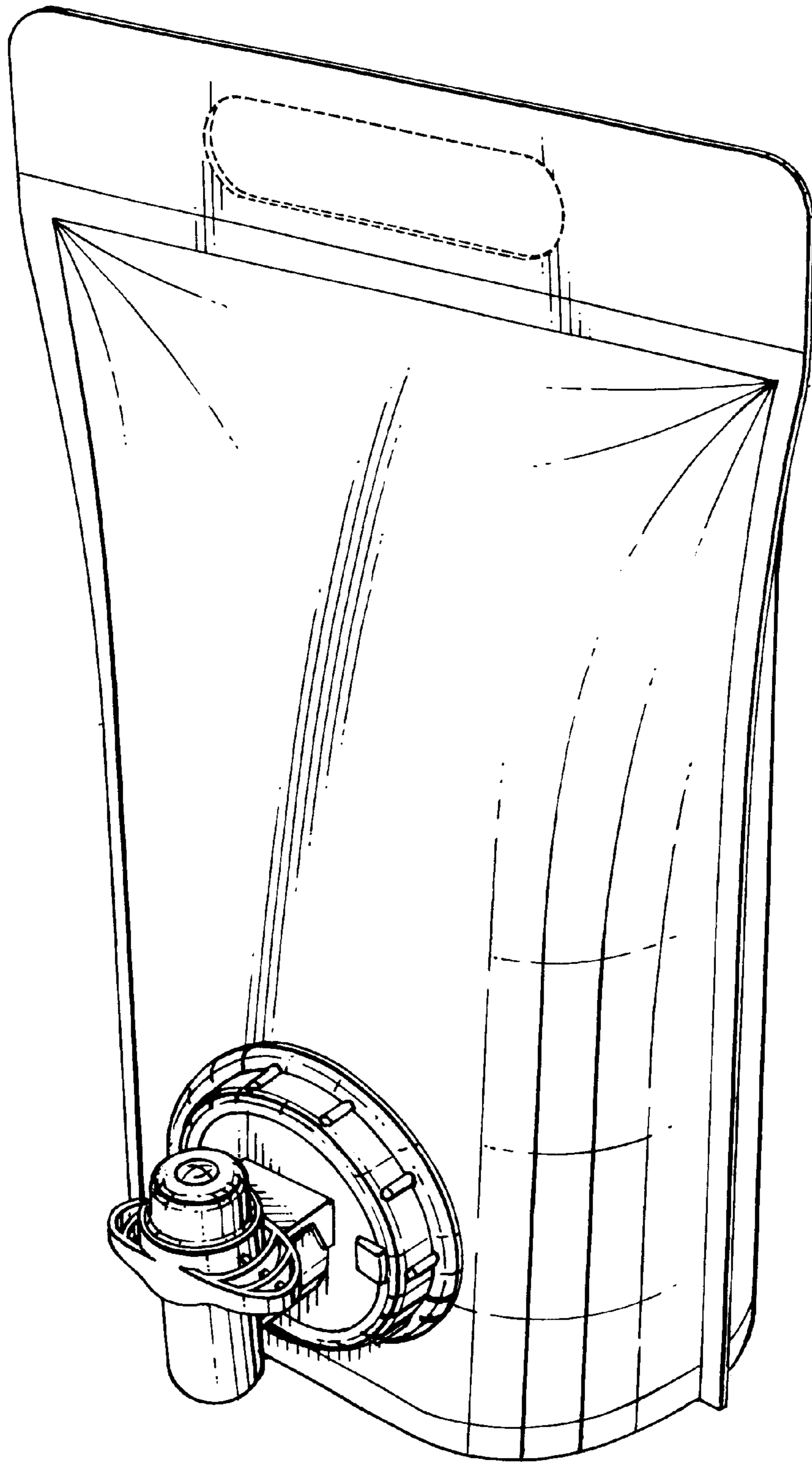

Fig. 1.

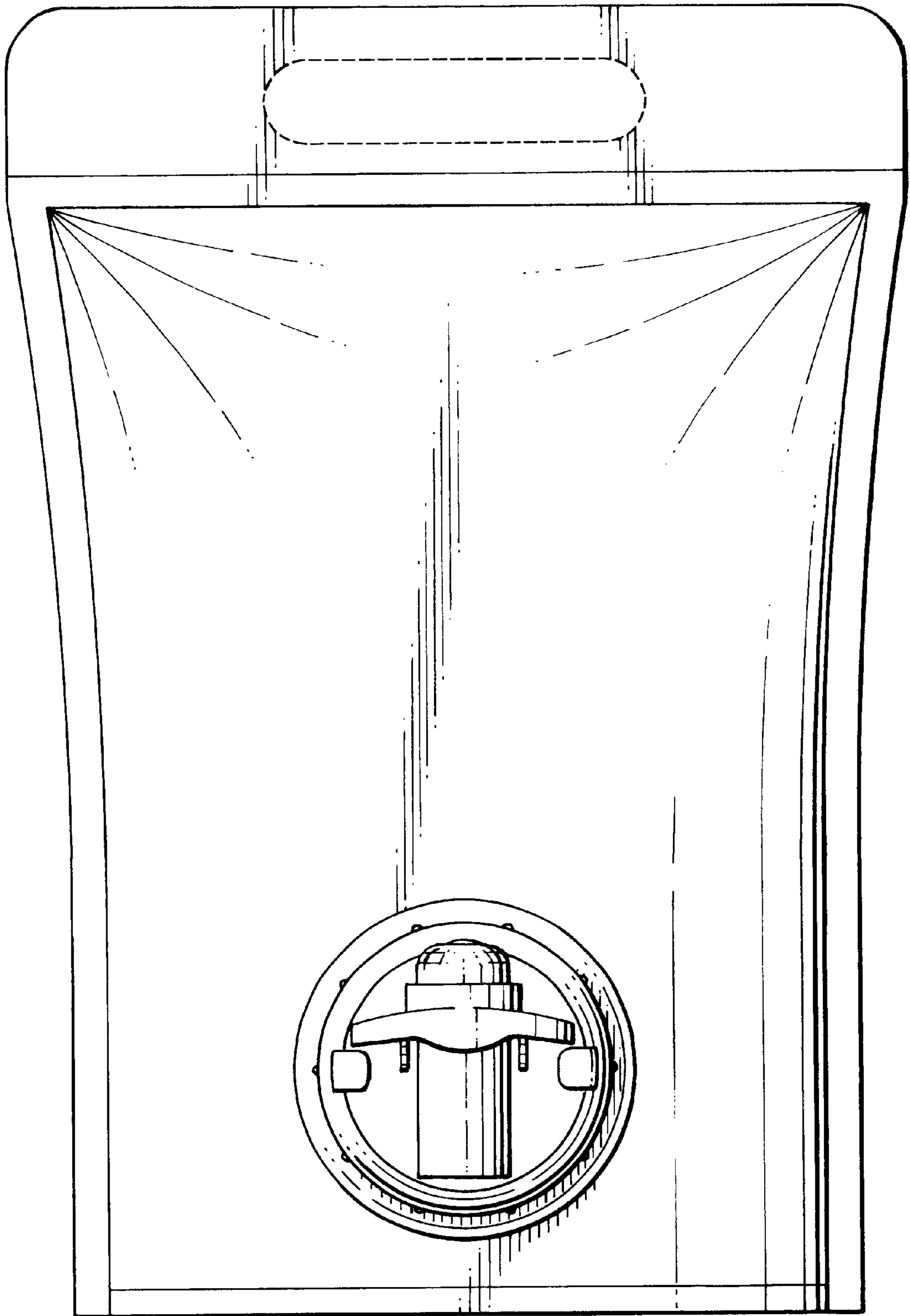

Fig.2.

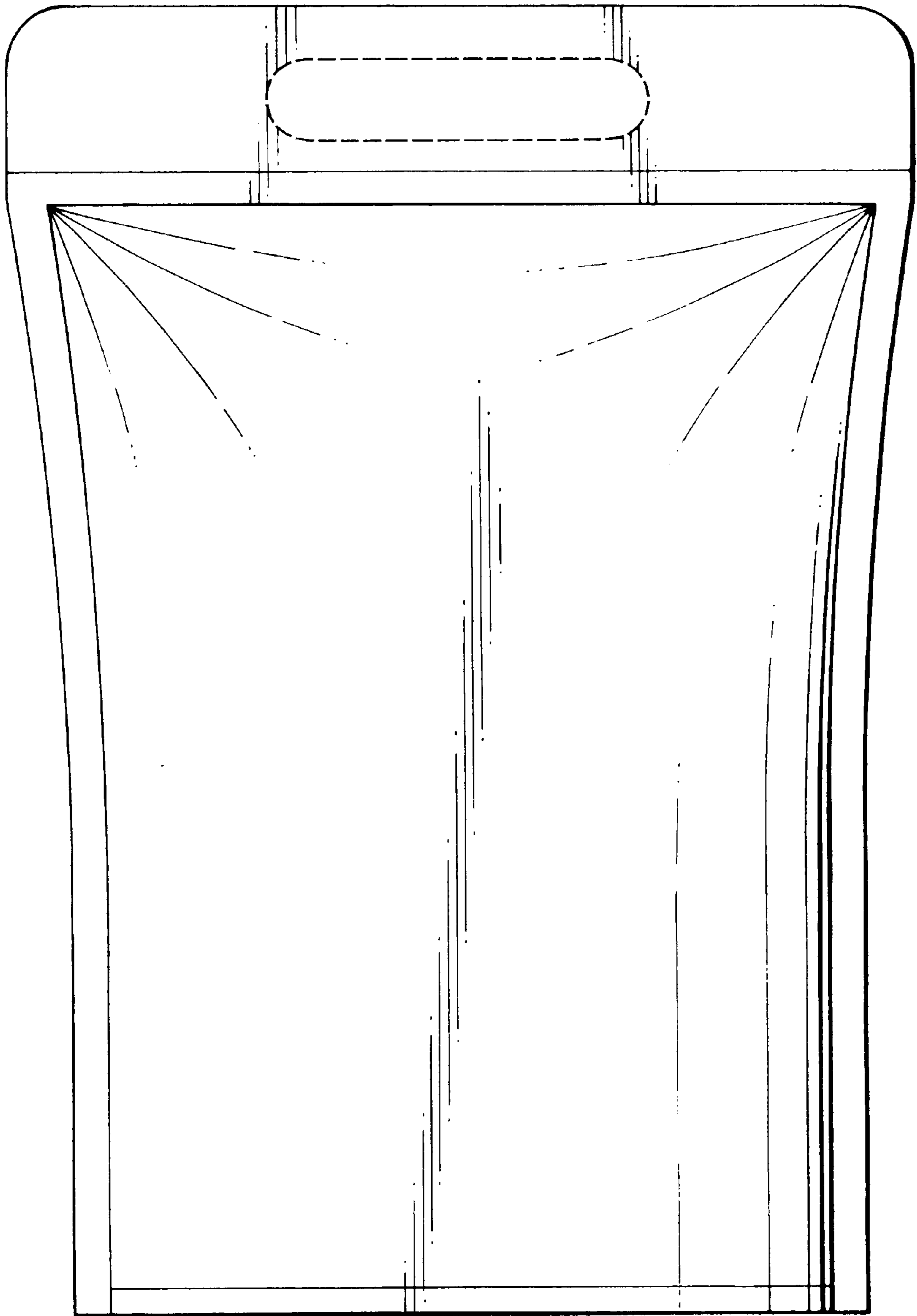

Fig.3.

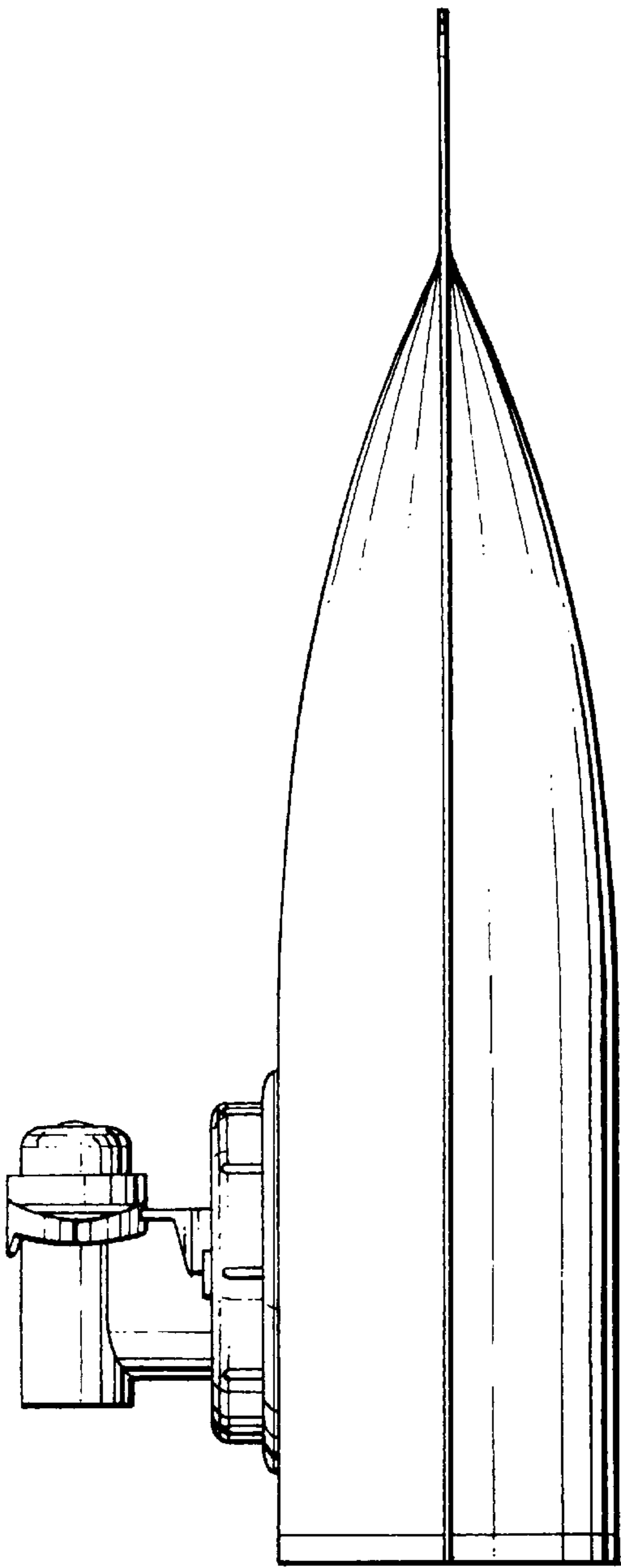

Fig.4.

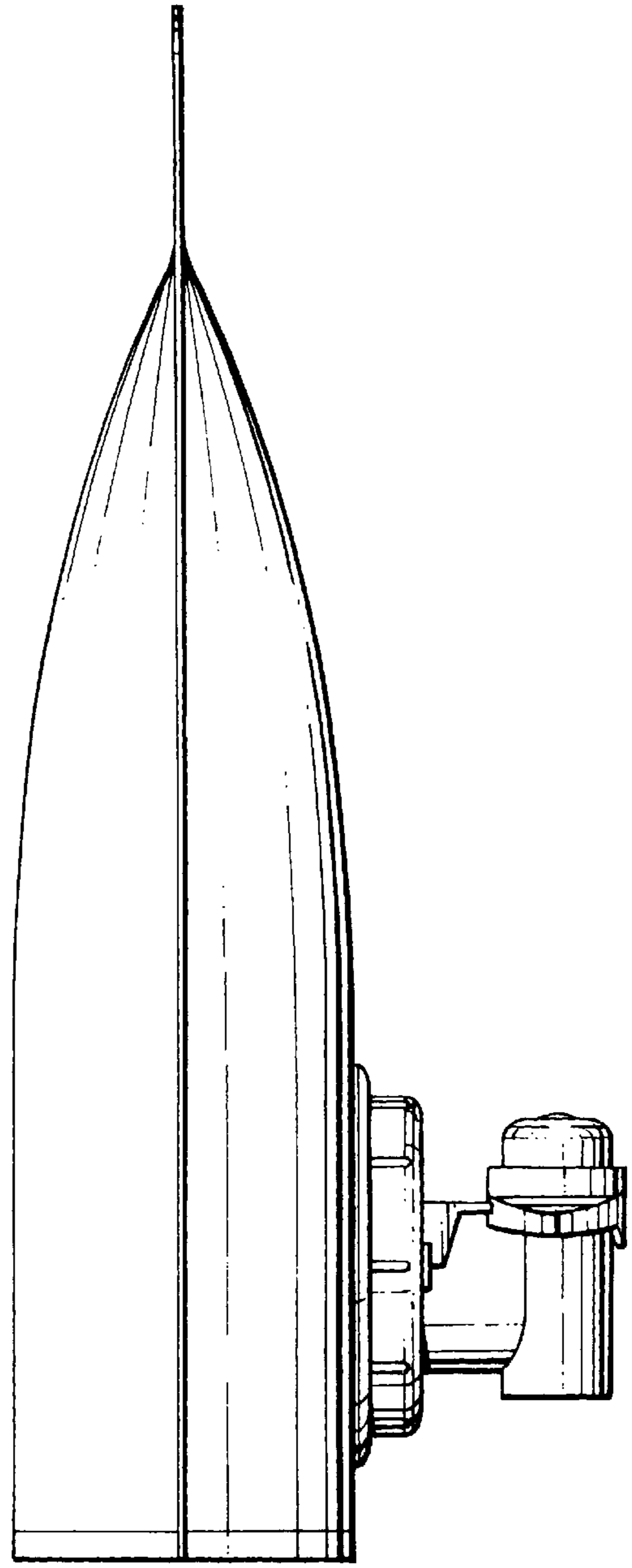

Fig.5.

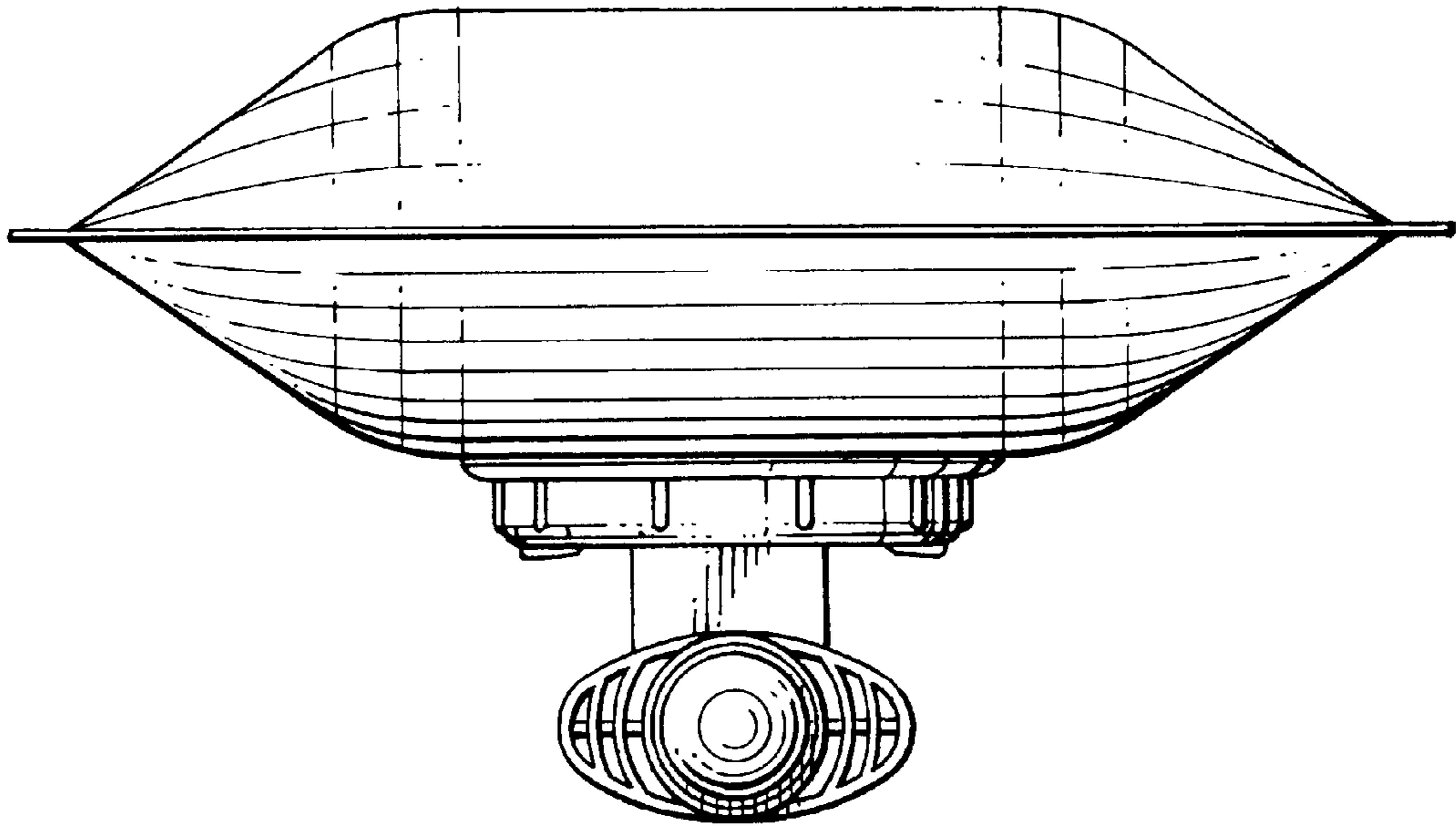

Fig. 6.

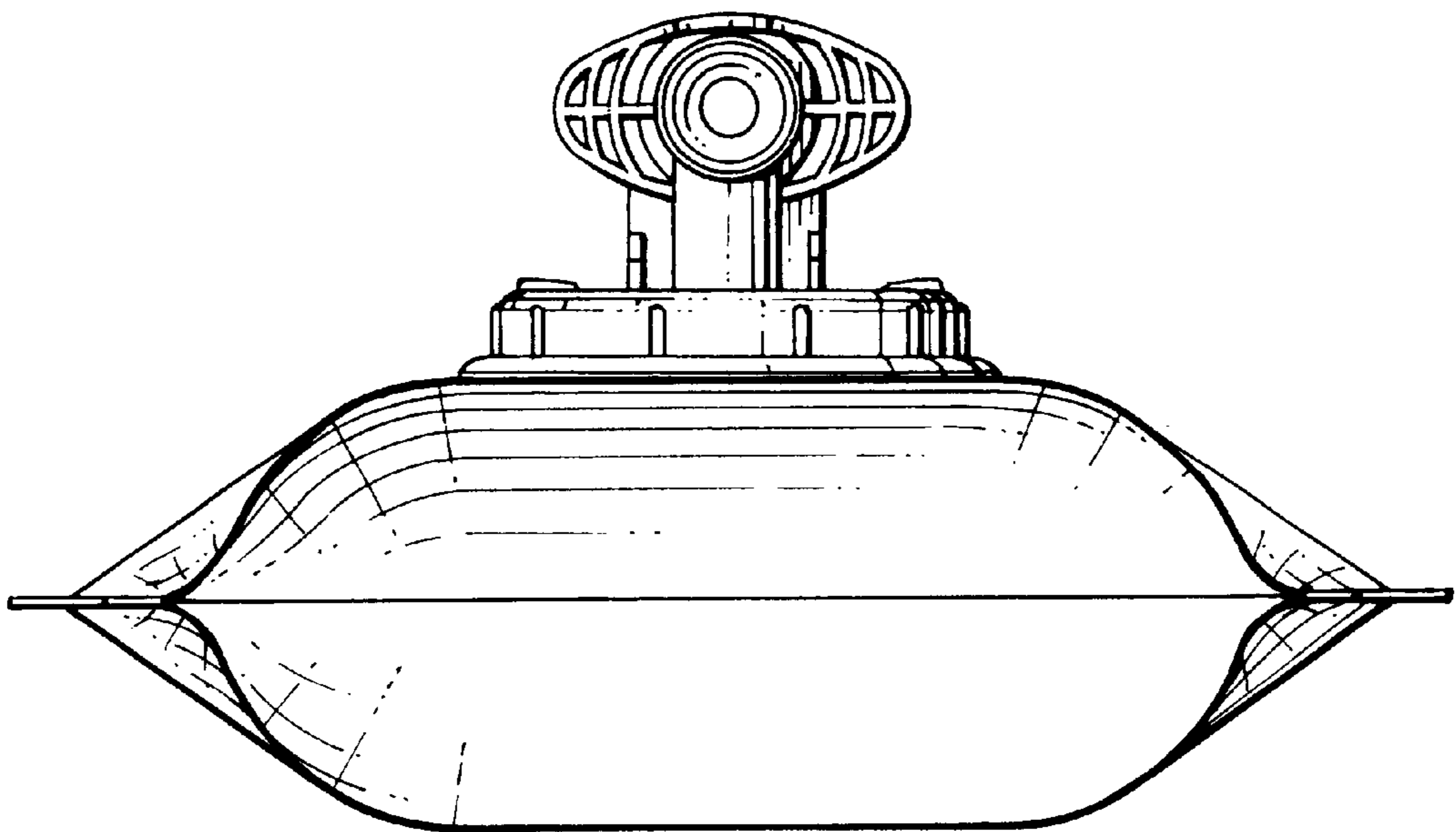

Fig. 7.

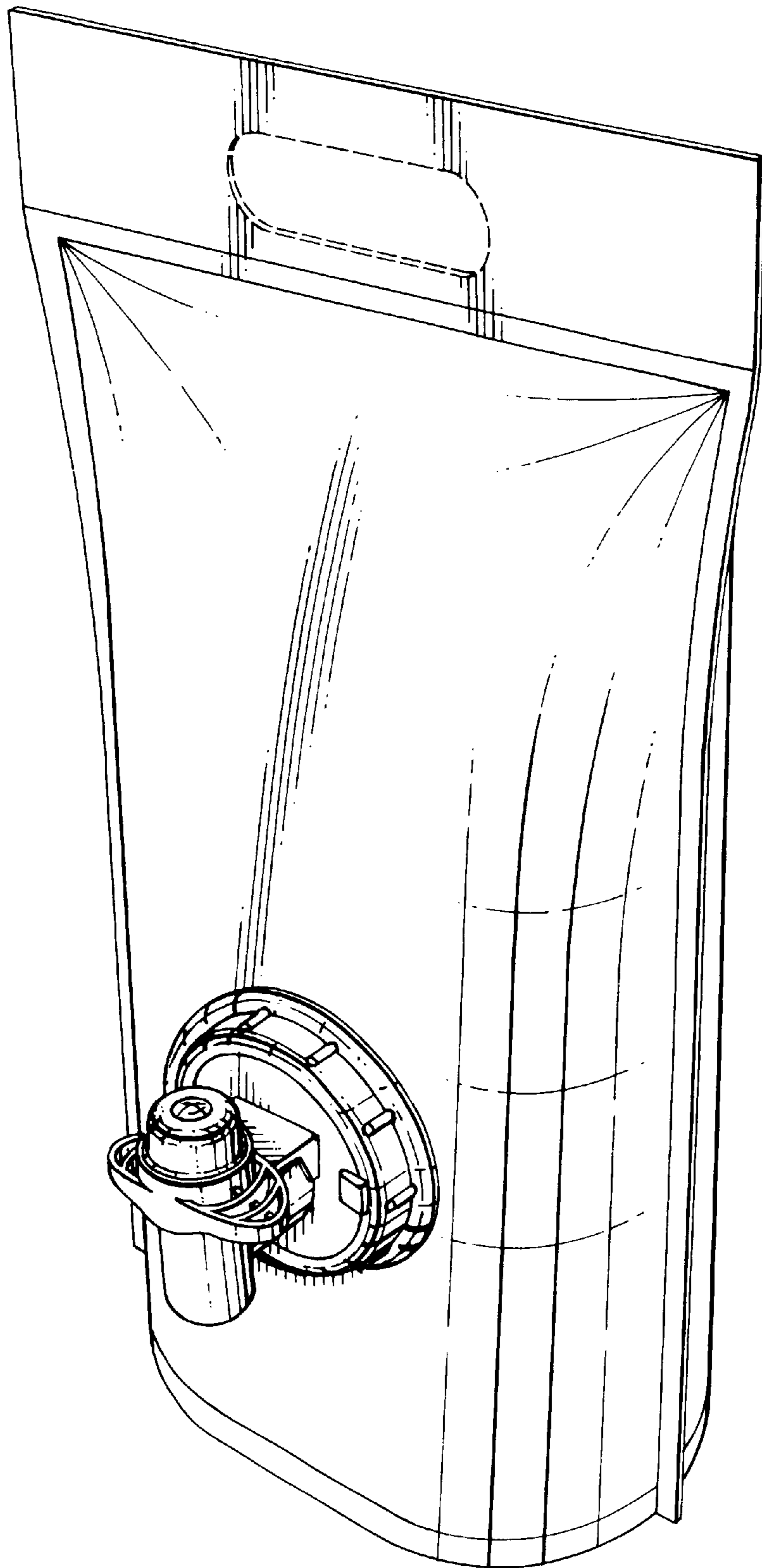

Fig.8.

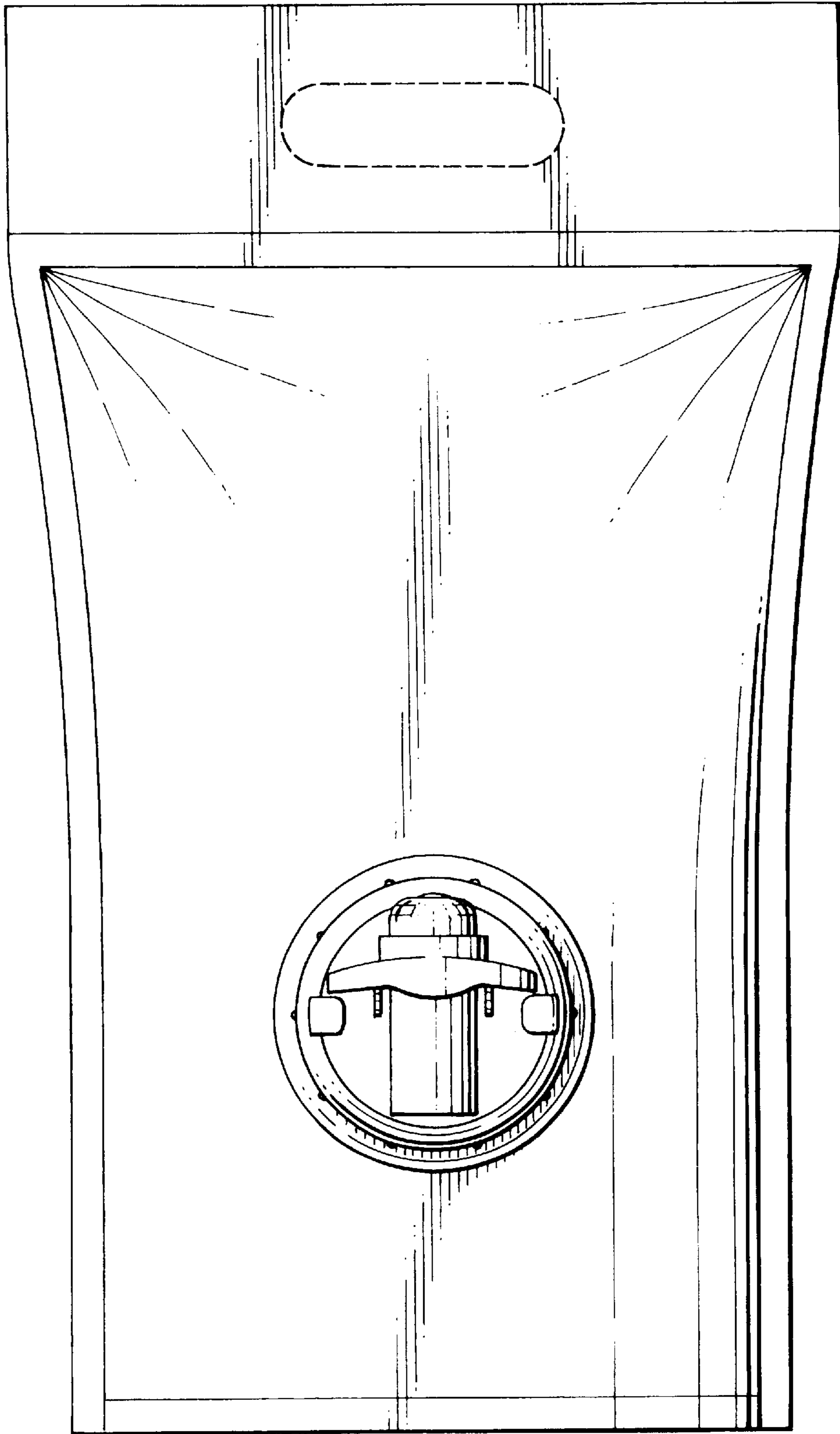

Fig.9.

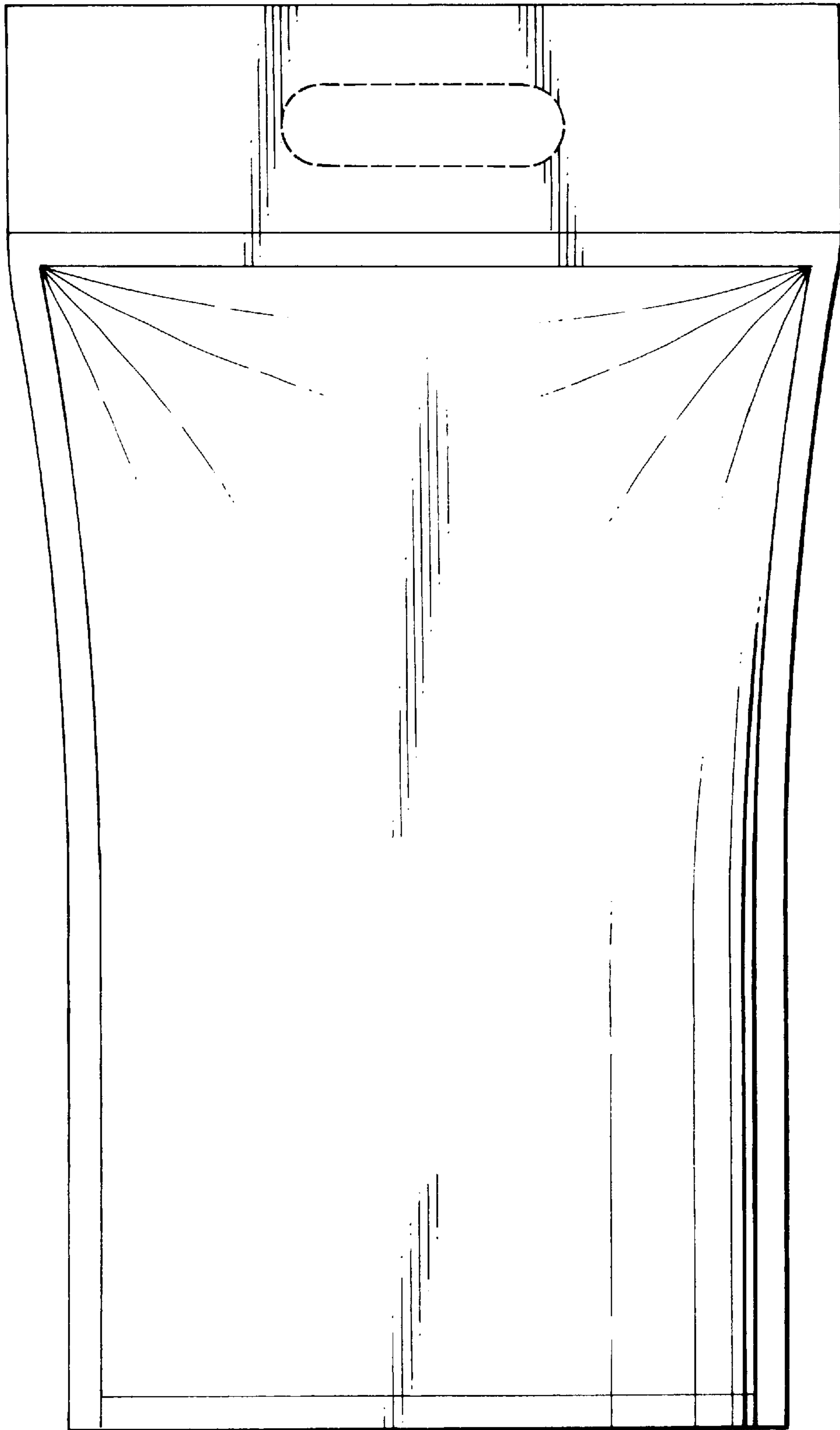

Fig.10.

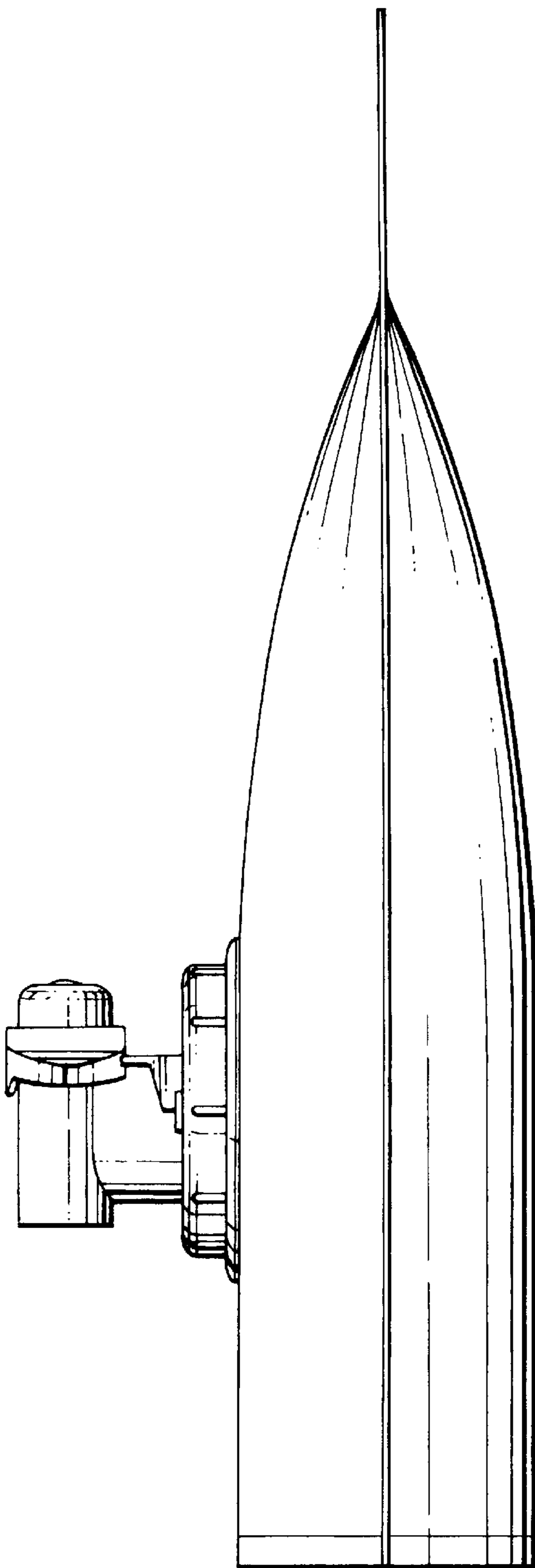

Fig. 11.

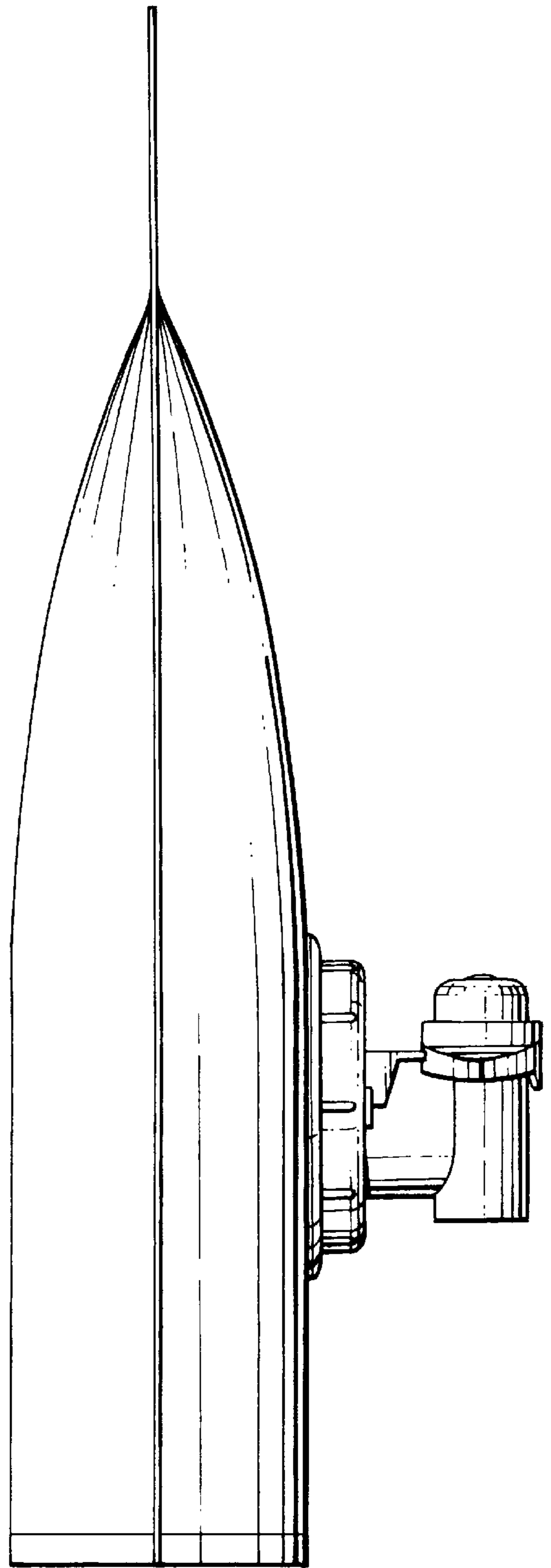

Fig. 12.

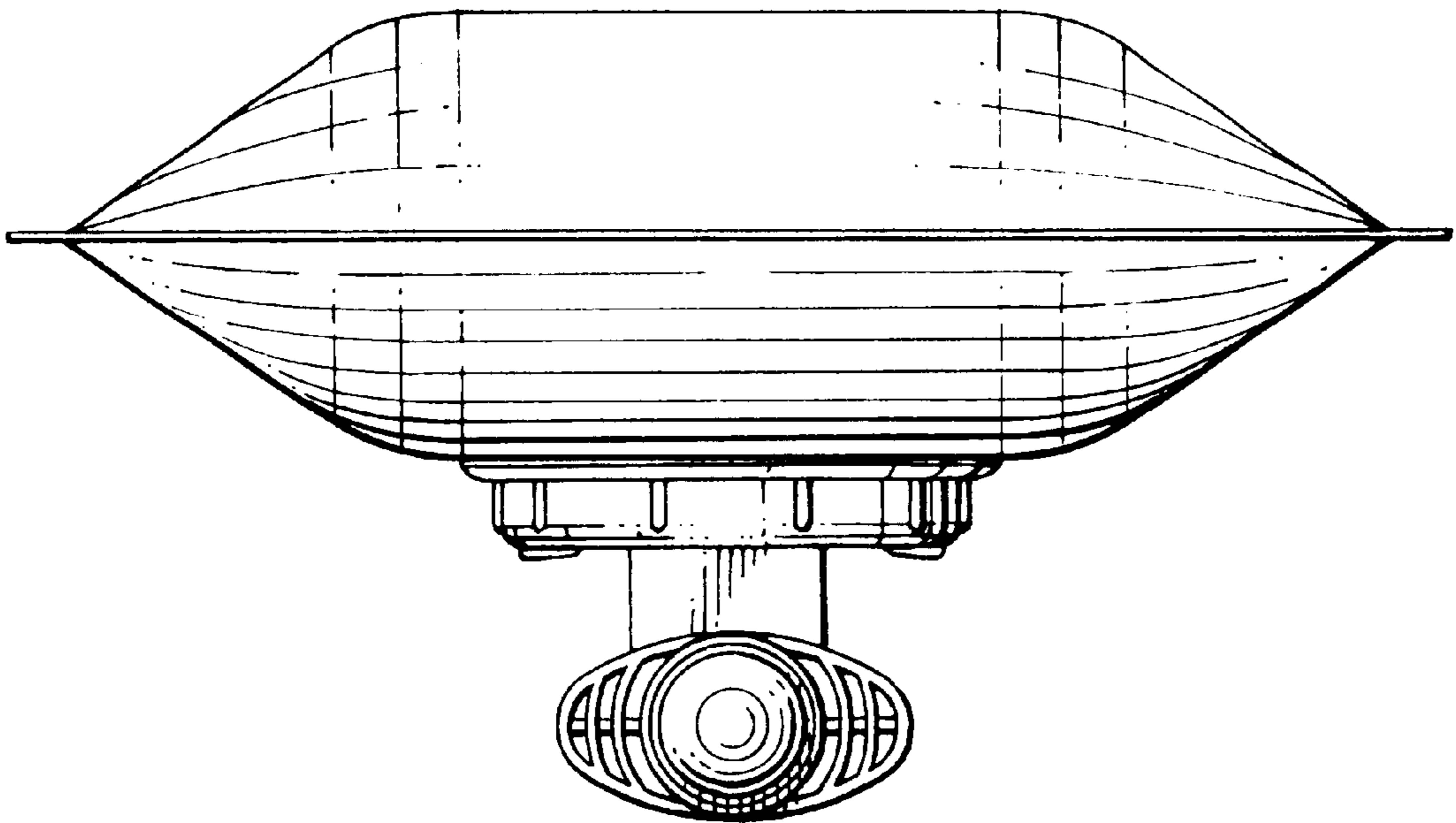

Fig. 13.

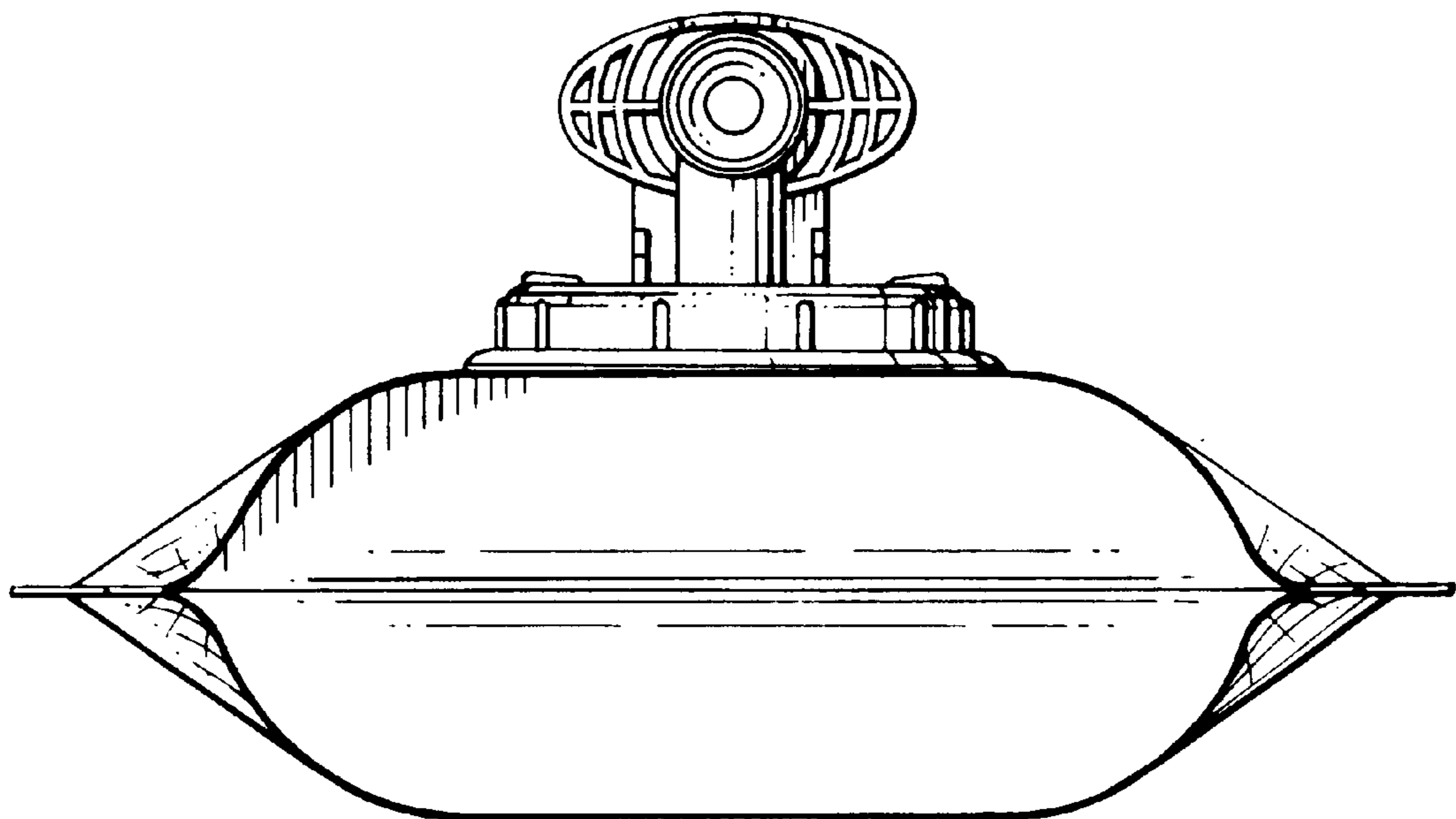

Fig. 14.