



US00D478492S

(12) **United States Design Patent**
Levine et al.

(10) **Patent No.:** **US D478,492 S**

(45) **Date of Patent:** **** Aug. 19, 2003**

(54) **HAMMER HANDLE**

(75) Inventors: **Steven R. Levine**, Mooresville, NC
(US); **Lindsay J. Klebenow**, Charlotte,
NC (US)

(73) Assignee: **Irwin Industrial Tool Company**,
Freeport, IL (US)

(**) Term: **14 Years**

(21) Appl. No.: **29/170,814**

(22) Filed: **Nov. 12, 2002**

(51) **LOC (7) Cl.** **08-02**

(52) **U.S. Cl.** **D8/80**

(58) **Field of Search** D8/75, 76, 77,
D8/78, 79, 80, 81, 107; 81/20, 21, 22, 23,
24, 25, 489, 177.1; 254/19; 16/110 R

(56) **References Cited**

U.S. PATENT DOCUMENTS

- D324,473 S * 3/1992 Chen D8/80
- D329,796 S * 9/1992 Olson et al. D8/80
- 5,372,053 A * 12/1994 Lee 81/20
- D376,089 S * 12/1996 Allen D8/80
- D403,223 S * 12/1998 Jacoff D8/80
- D407,000 S * 3/1999 Jacoff D8/80

- D420,881 S * 2/2000 Davis et al. D8/75
- D424,399 S * 5/2000 Staton D8/107
- D432,381 S * 10/2000 Khachatoorian D8/80
- D466,390 S * 12/2002 Hung D8/107

* cited by examiner

Primary Examiner—Philip S. Hyder

(74) *Attorney, Agent, or Firm*—Brinks Hofer Gilson &
Lione

(57) **CLAIM**

The ornamental design for a hammer handle, as shown and
described.

DESCRIPTION

FIG. 1 is a perspective view of an embodiment of the
hammer handle;
FIG. 2 is a side view of the embodiment of FIG. 1, the
opposite side being a mirror image;
FIG. 3 is a front view of the embodiment of FIG. 1;
FIG. 4 is a rear view of the embodiment of FIG. 1;
FIG. 5 is a top plan view taken from the direction of arrows
5—5 of FIG. 2; and,
FIG. 6 is a bottom view of the embodiment of FIG. 1.
The dotted lines indicate components for illustrative pur-
poses only and form no part of the subject design.

1 Claim, 5 Drawing Sheets

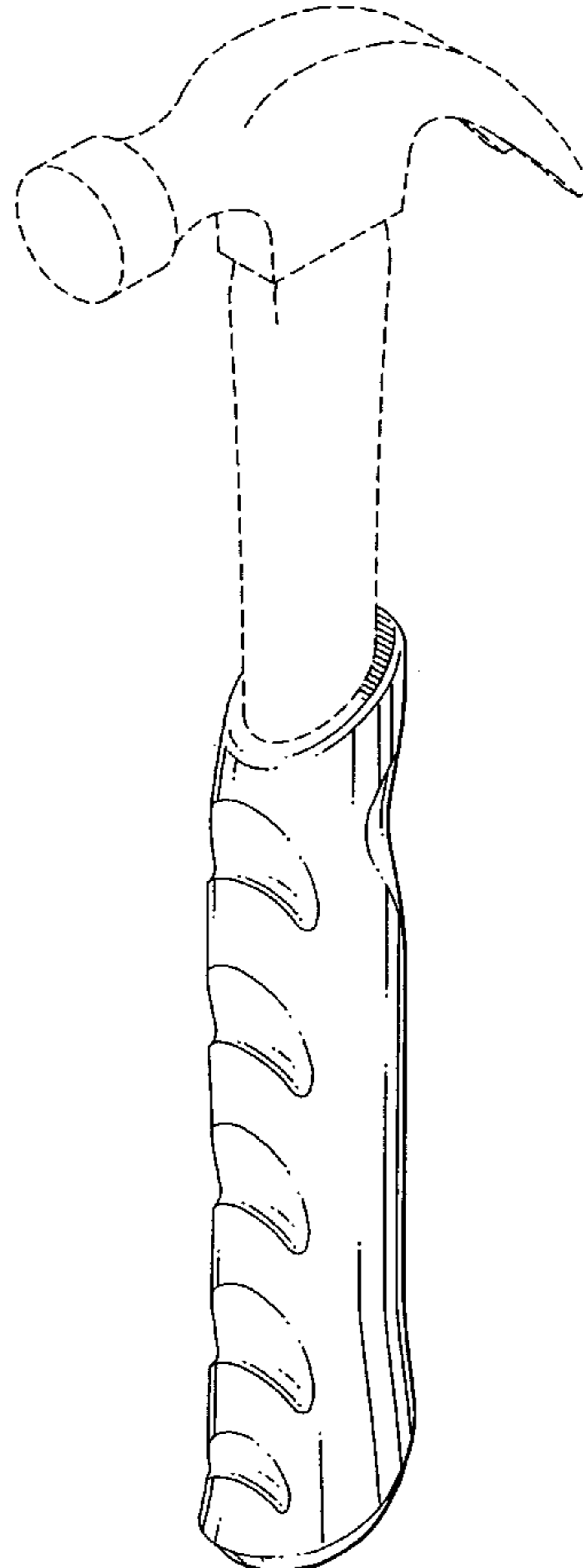

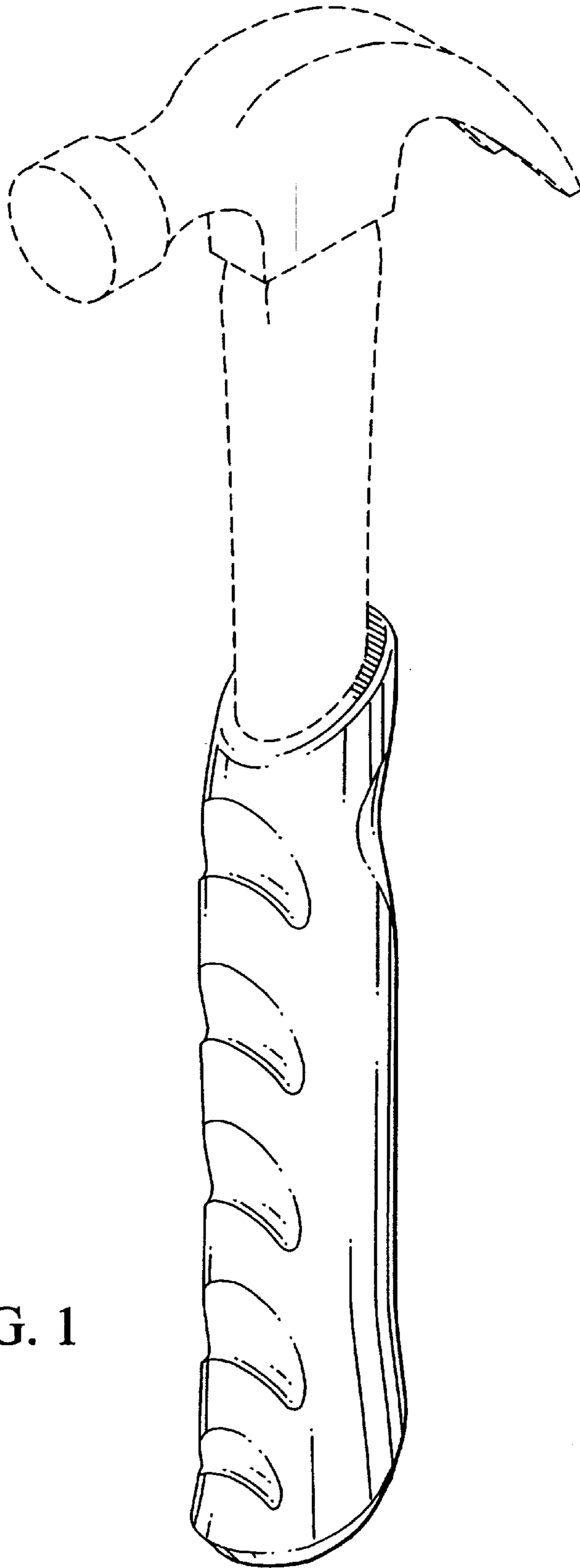

FIG. 1

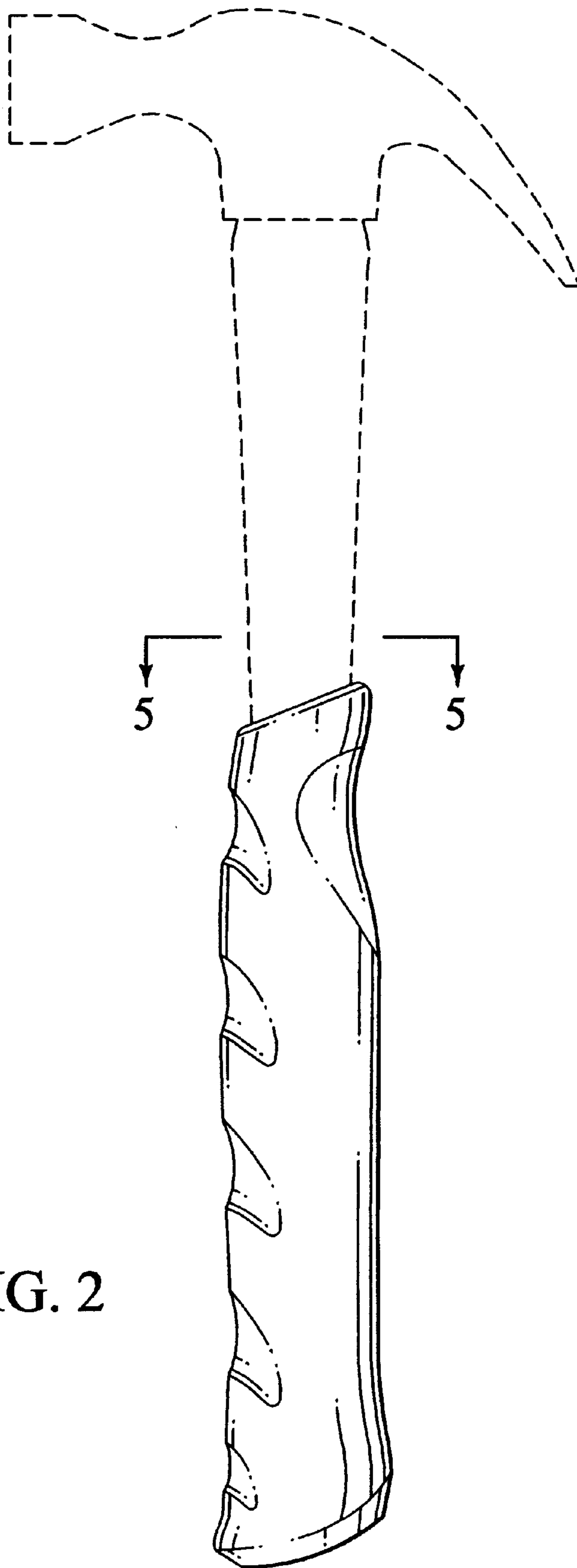

FIG. 2

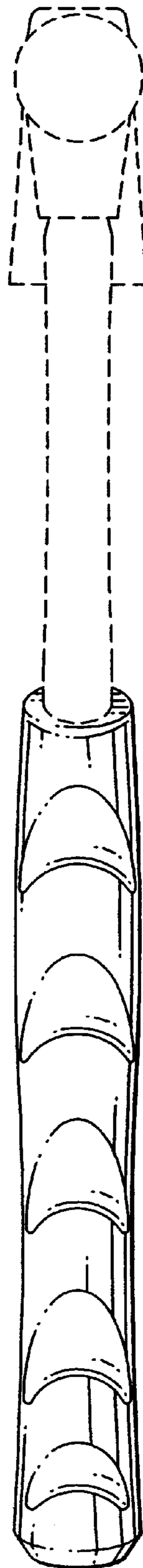

FIG. 3

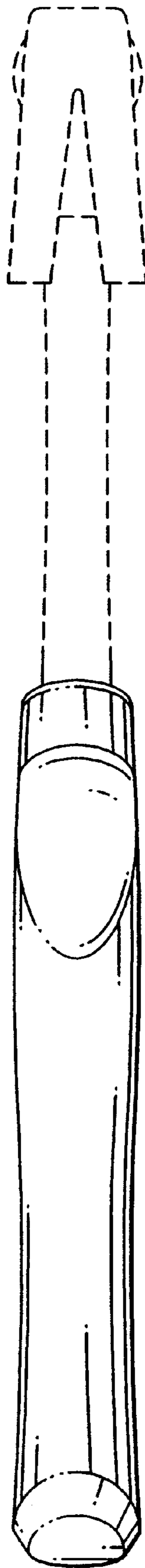

FIG. 4

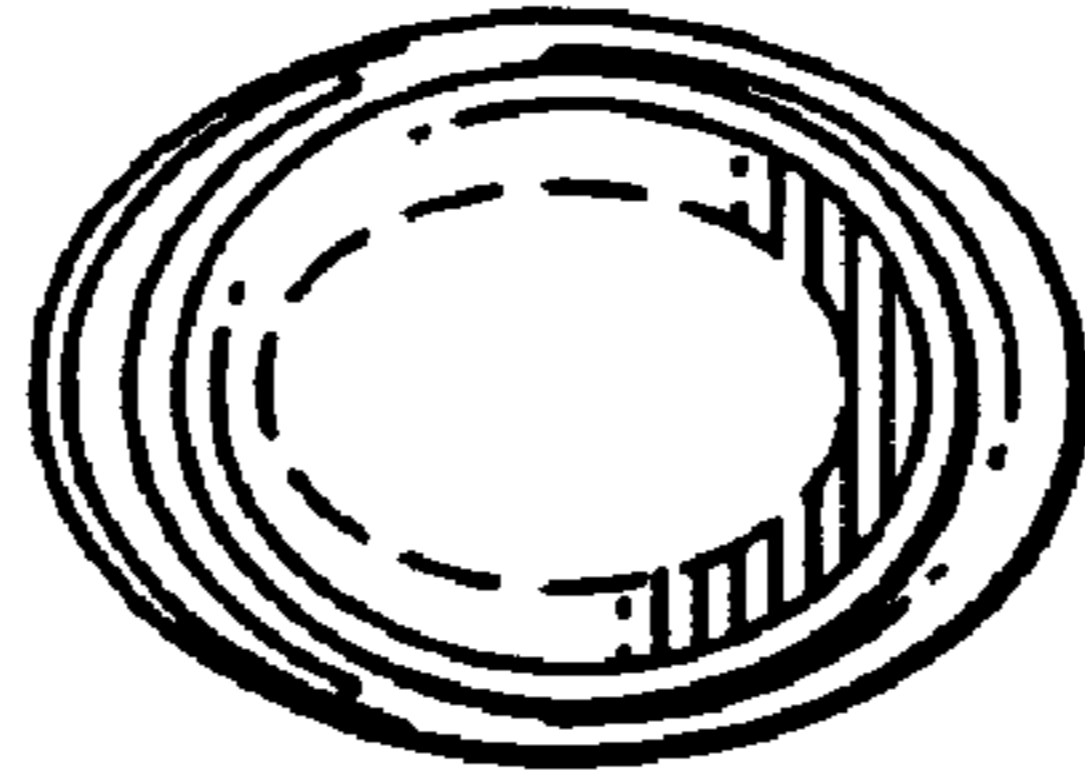

FIG. 5

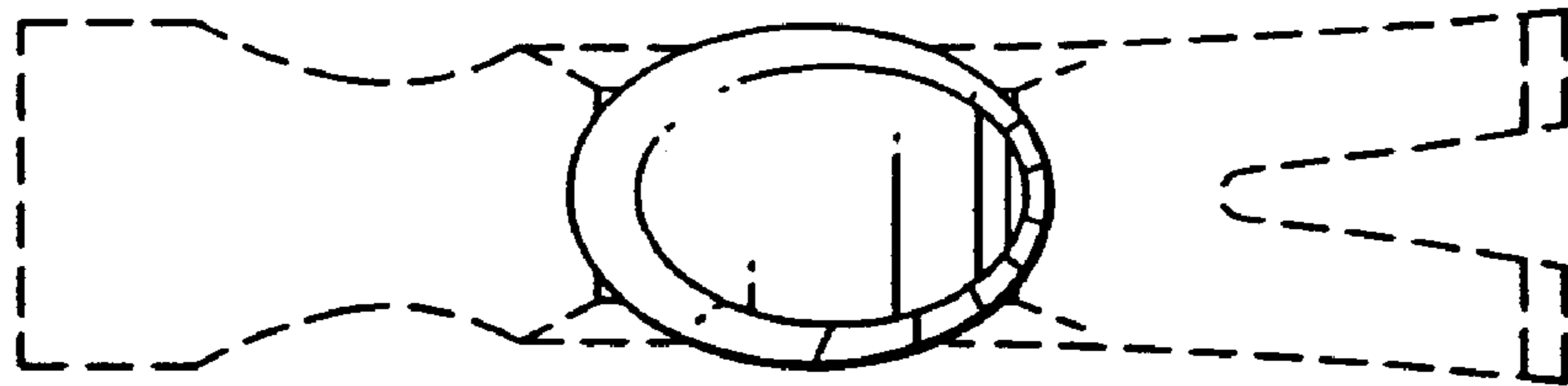

FIG. 6