



US00D478480S

(12) **United States Design Patent**  
**Leon**

(10) **Patent No.:** **US D478,480 S**

(45) **Date of Patent:** **\*\* Aug. 19, 2003**

(54) **BOTTLE COASTER**

D425,757 S \* 5/2000 Printz et al. .... D7/510

(76) Inventor: **Richard W. Leon**, 13002 Ledford St.,  
Baldwin Park, CA (US) 91706

\* cited by examiner

(\*\*) Term: **14 Years**

*Primary Examiner*—Terry A. Wallace

(74) *Attorney, Agent, or Firm*—Boniard I. Brown

(21) Appl. No.: **29/158,242**

(57) **CLAIM**

(22) Filed: **Apr. 2, 2002**

The ornamental design for a bottle coaster, as shown and described.

(51) **LOC (7) Cl.** ..... **07-06**

**DESCRIPTION**

(52) **U.S. Cl.** ..... **D7/624**

(58) **Field of Search** ..... D7/619, 625; D6/449,  
D6/466, 467, 300; D21/717, 718; 211/71.01,  
74, 75; 248/309.1, 311.2, 146, 176.1, 346.01,  
346.11, 346.5

FIG. 1 is a front perspective view of a bottle coaster, showing my new design;

FIG. 2 is a top plan view thereof;

FIG. 3 is a front elevational view thereof;

FIG. 4 is a side elevational view thereof, the opposite side being a mirror image;

FIG. 5 is a rear elevational view thereof; and,

FIG. 6 is a bottom plan view thereof.

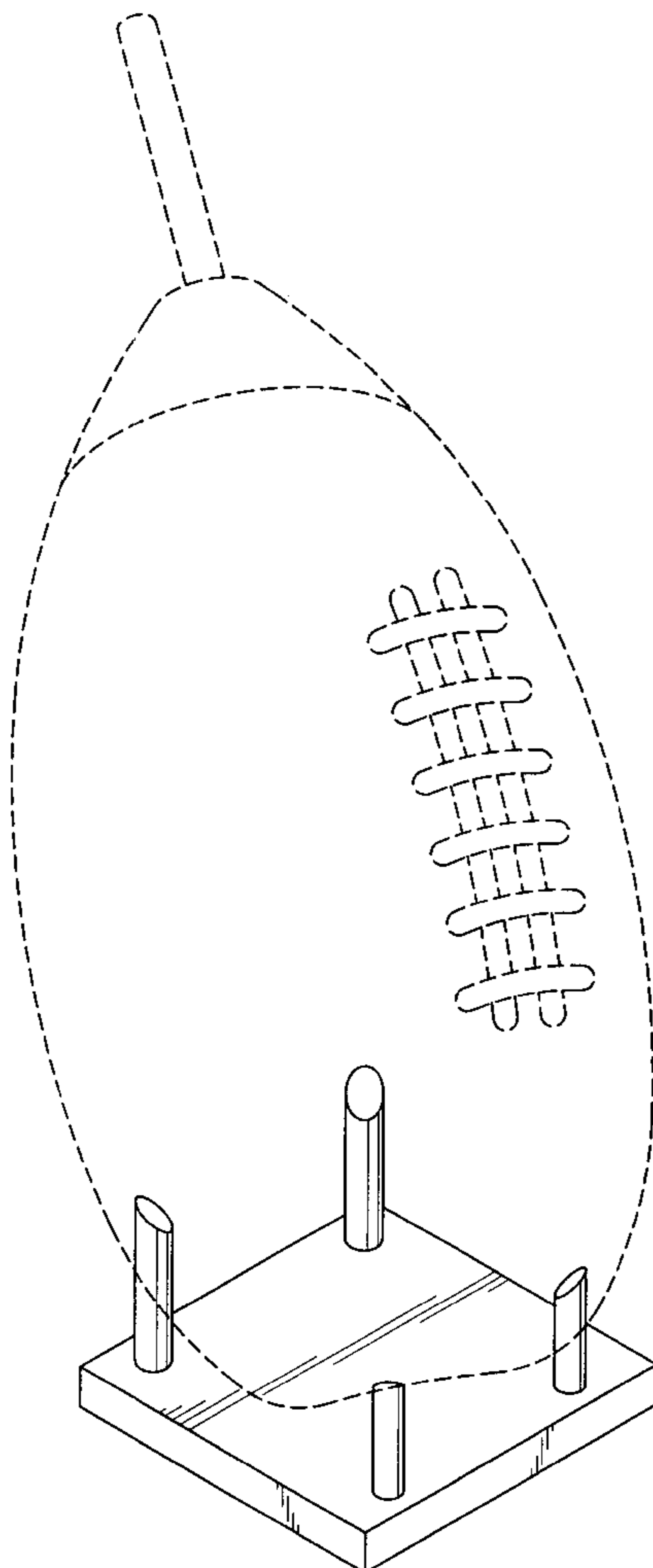
The broken line showing of a football-shaped drinking vessel in FIG. 1 is for illustrative purposes only and forms no part of the claimed design.

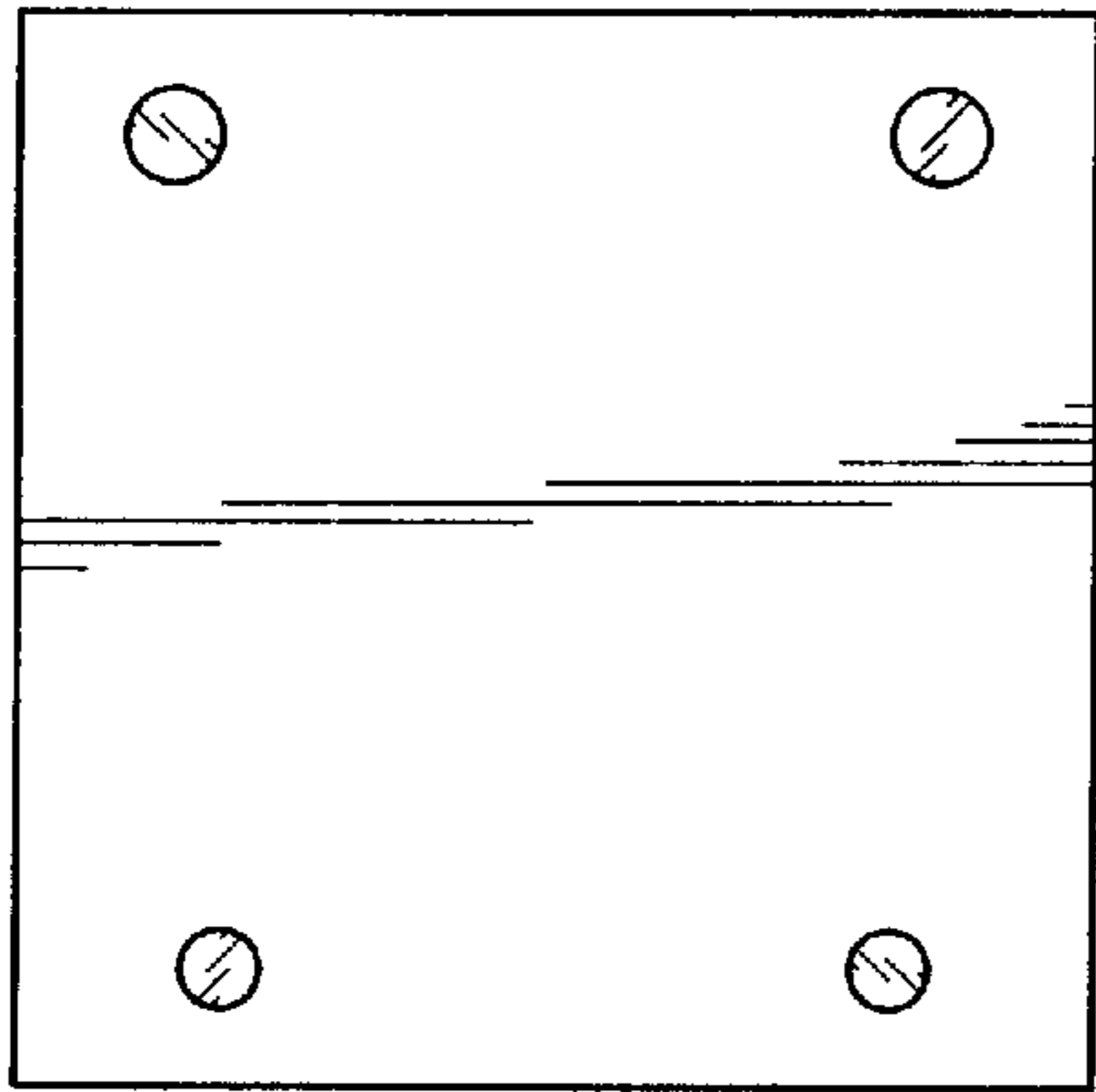
(56) **References Cited**

**U.S. PATENT DOCUMENTS**

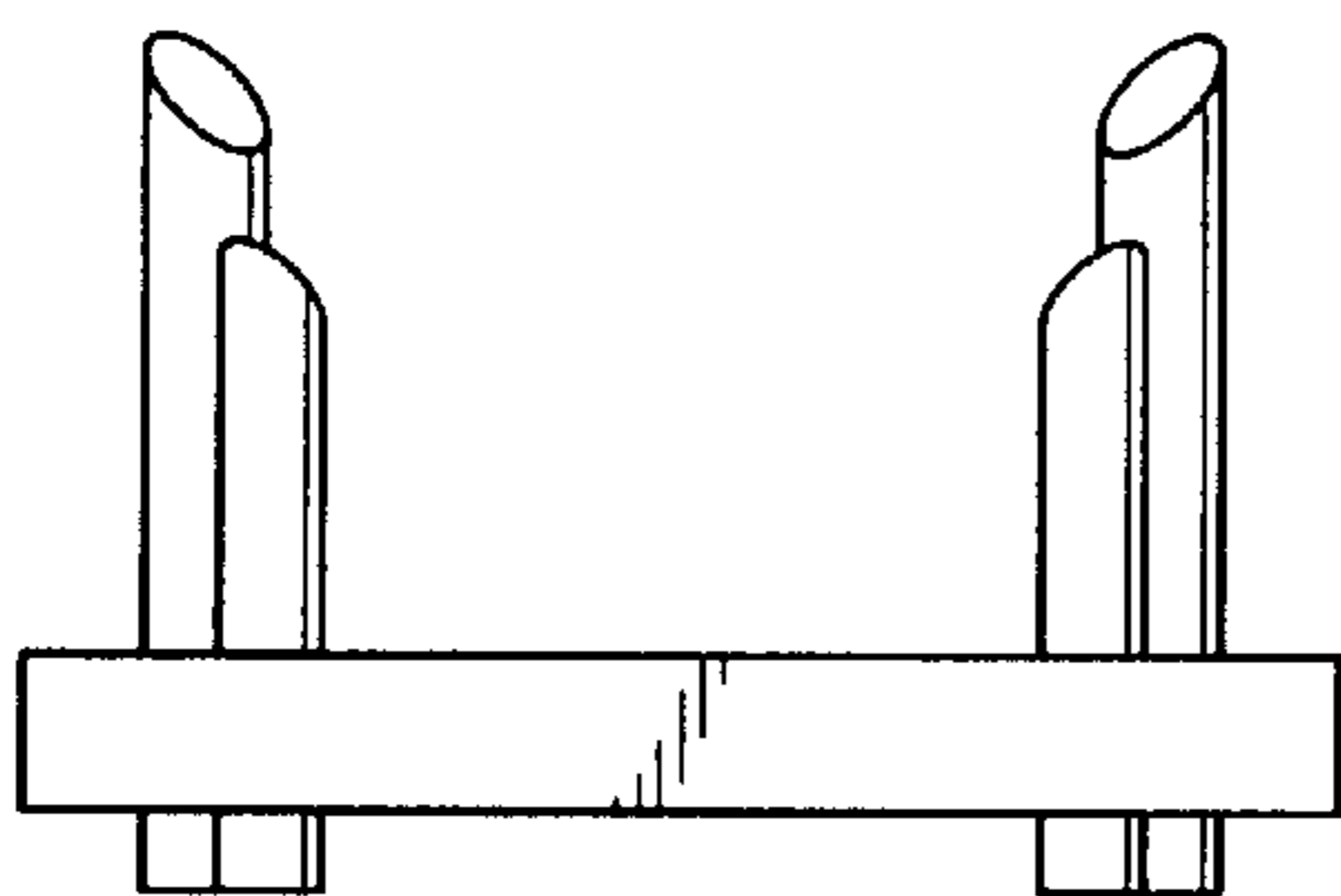
D184,210 S	*	1/1959	Bernabo	.....	D7/624
D228,328 S	*	9/1973	Schley	.....	D21/712
D260,070 S	*	8/1981	Haverland et al.	.....	D7/624
D304,280 S	*	10/1989	Leighton	.....	D7/641
5,662,241 A	*	9/1997	Sorensen	.....	D21/716

**1 Claim, 2 Drawing Sheets**

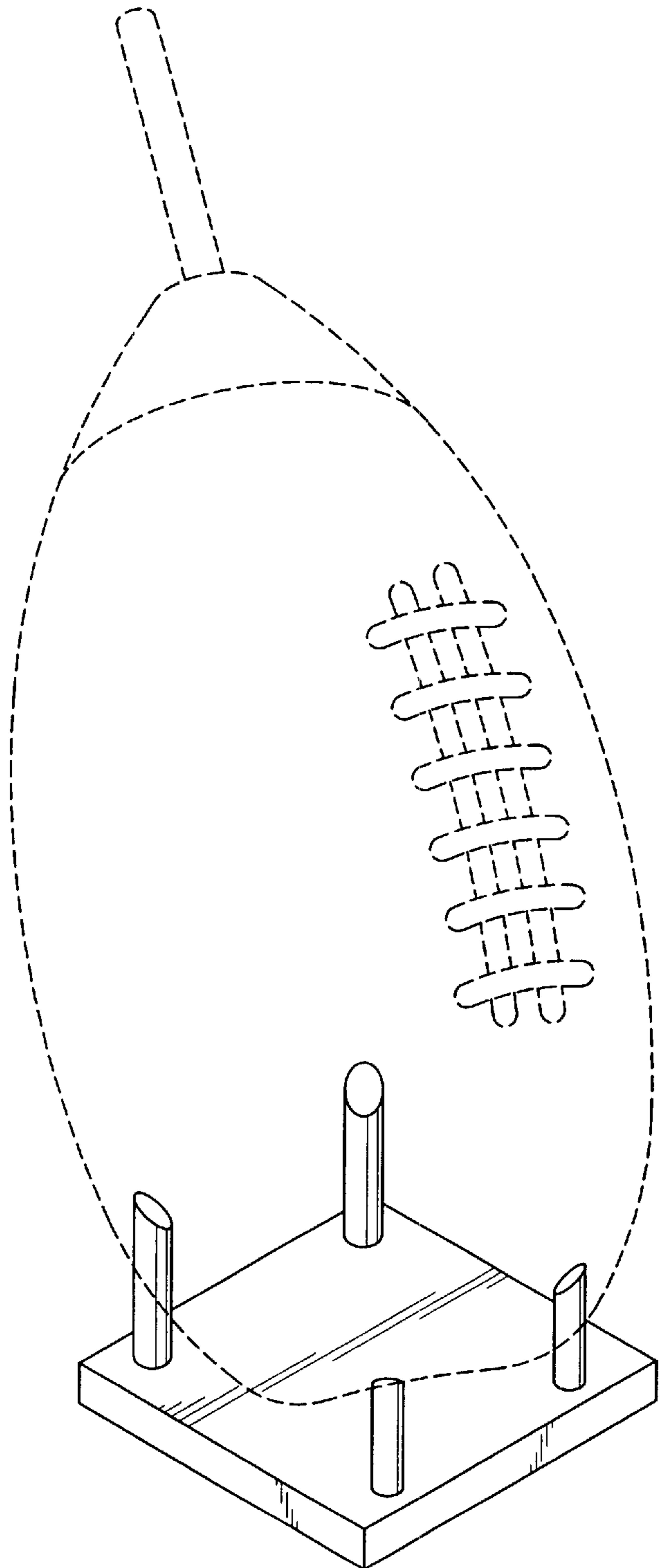




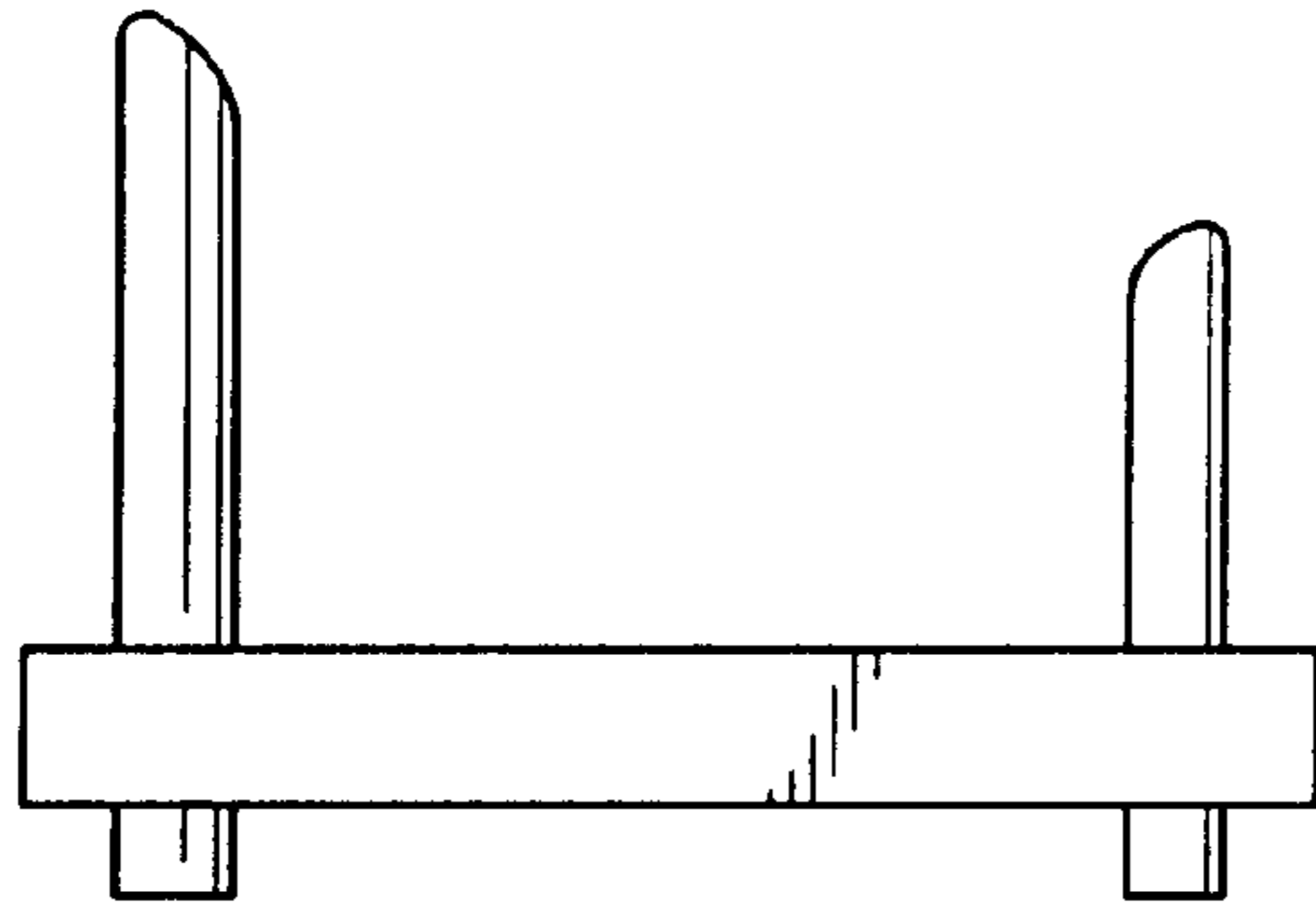
*FIG. 2*



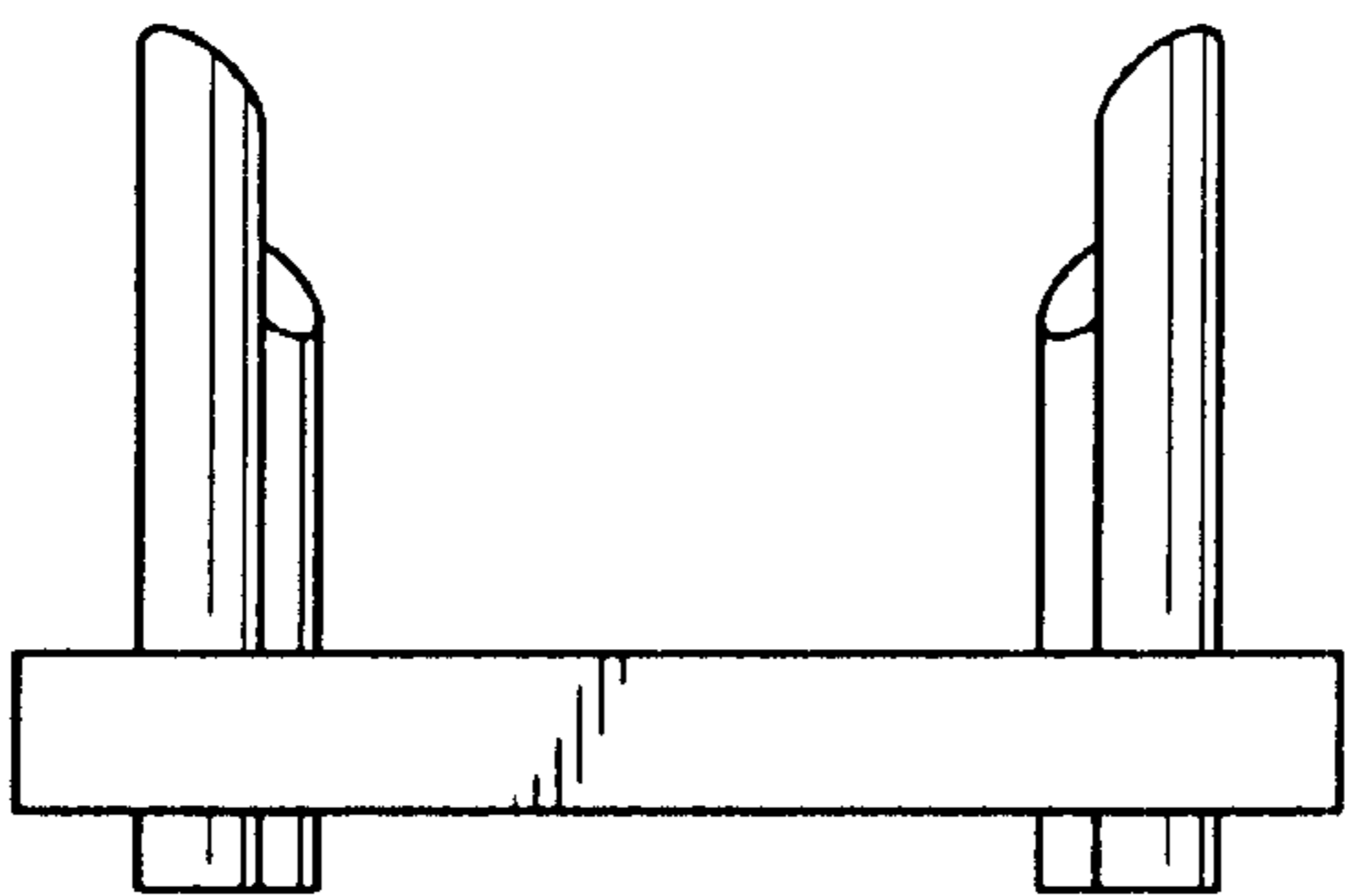
*FIG. 3*



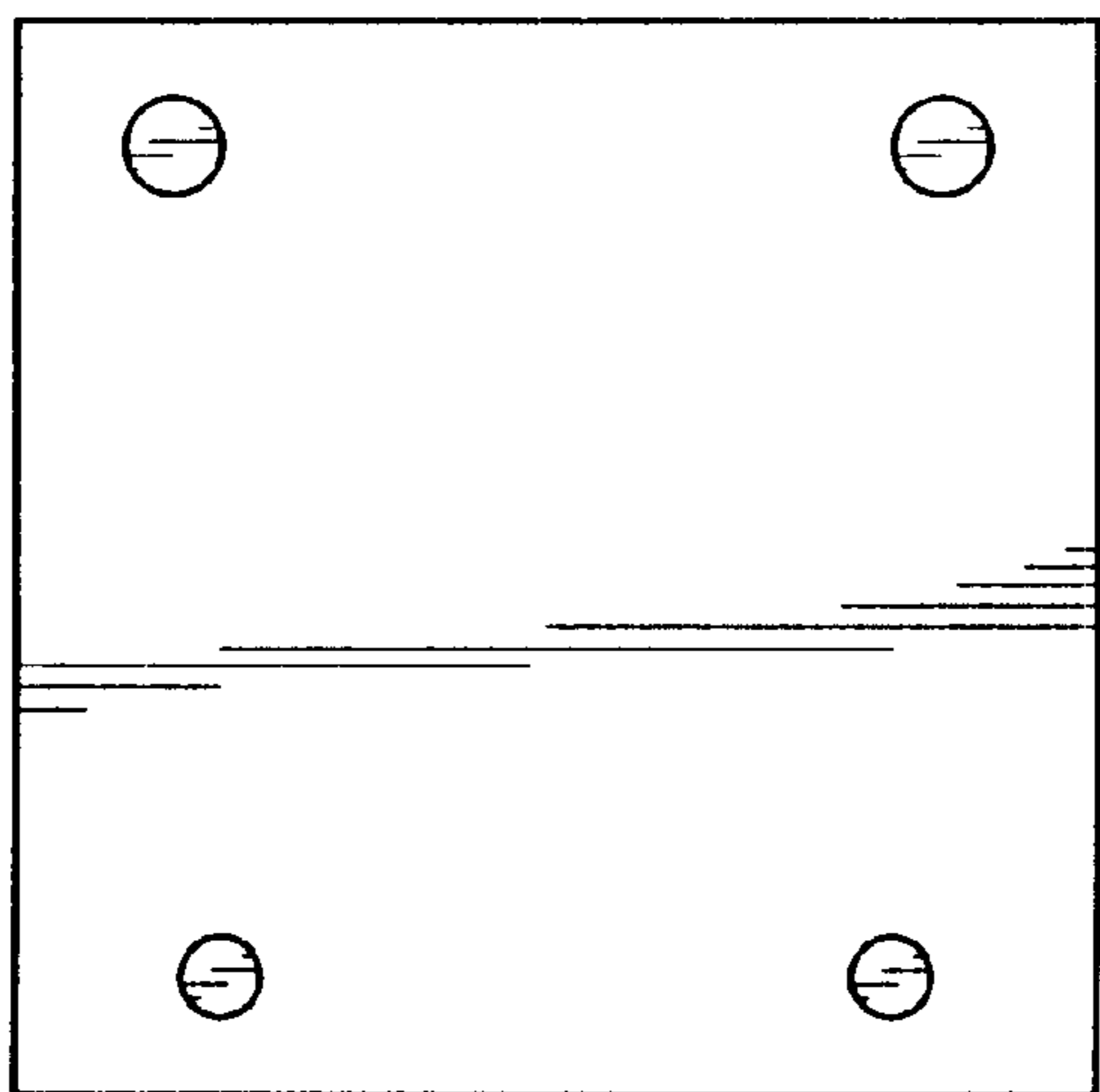
*FIG. 1*



*FIG. 4*



*FIG. 5*



*FIG. 6*