



US00D478427S

(12) **United States Design Patent**
Ford et al.

(10) **Patent No.: US D478,427 S**

(45) **Date of Patent: ** Aug. 19, 2003**

(54) **BOWLING TABLE WITH MULTIPLE SEATING ARRANGEMENTS**

(75) Inventors: **Gary J. Ford**, Chesterfield, VA (US);
William Bredlow, Baltimore, MD (US); **Brian Williamson**, Richmond, VA (US)

(73) Assignee: **AMF Bowling Worldwide, Inc.**, Mechanicsville, VA (US)

(**) Term: **14 Years**

(21) Appl. No.: **29/162,606**

(22) Filed: **Jun. 17, 2002**

(51) **LOC (7) Cl. 06-01**

(52) **U.S. Cl. D6/337**

(58) **Field of Search** D6/334, 335, 336, D6/337, 369, 370, 376, 381, 494, 495, 498, 499, 500-502; 297/157.1, 158.1, 158.3, 158.4, 158.5, 159.1; 473/54

(56) **References Cited**

U.S. PATENT DOCUMENTS

D173,910 S	*	1/1955	Neuendorf	D6/337
D196,121 S	*	8/1963	Soszynski	D6/337
D206,998 S	*	2/1967	Benjamin	D6/337
D222,806 S	*	1/1972	Wise	D6/337
D272,302 S	*	1/1984	Connelly	D6/337
D339,487 S		9/1993	Rizzi		
D367,772 S	*	3/1996	Stirling et al.	D6/337
D377,124 S		1/1997	Stirling et al.		
D379,874 S		6/1997	Stirling et al.		
D409,008 S	*	5/1999	Lunn	D6/337
D412,415 S		8/1999	Adler et al.		
D427,802 S		7/2000	Adler et al.		
D456,645 S		5/2002	Iverson		

* cited by examiner

Primary Examiner—Doris V. Coles

Assistant Examiner—Mimosa De

(74) *Attorney, Agent, or Firm*—McGuireWoods LLP

(57) **CLAIM**

We claim the ornamental design for a bowling table with multiple seating arrangements, as shown and described.

DESCRIPTION

FIG. 1 is a front perspective view of the bowling table with multiple seating arrangements, in which there are four seats, in accordance with a first embodiment of the present invention;

FIG. 2 is a right side perspective view thereof;

FIG. 3 is a left side perspective view thereof;

FIG. 4 is a top plan view thereof;

FIG. 5 is a front elevation view thereof;

FIG. 6 is a rear elevation view thereof;

FIG. 7 is a left side elevation view thereof

FIG. 8 is a right side elevation view thereof;

FIG. 9 is a bottom plan view thereof;

FIG. 10 is a bottom perspective view thereof;

FIG. 11 is a front perspective view of the bowling table with multiple seating arrangements, in which there are six seats, in accordance with a second embodiment of the present invention;

FIG. 12 is a right side perspective view thereof;

FIG. 13 is a left side perspective view thereof;

FIG. 14 is a top plan view thereof;

FIG. 15 is a front elevation view thereof;

FIG. 16 is a rear elevation view thereof;

FIG. 17 is a left side elevation view thereof

FIG. 18 is a right side elevation view thereof;

FIG. 19 is a bottom plan view thereof; and,

FIG. 20 is a bottom perspective view thereof.

1 Claim, 20 Drawing Sheets

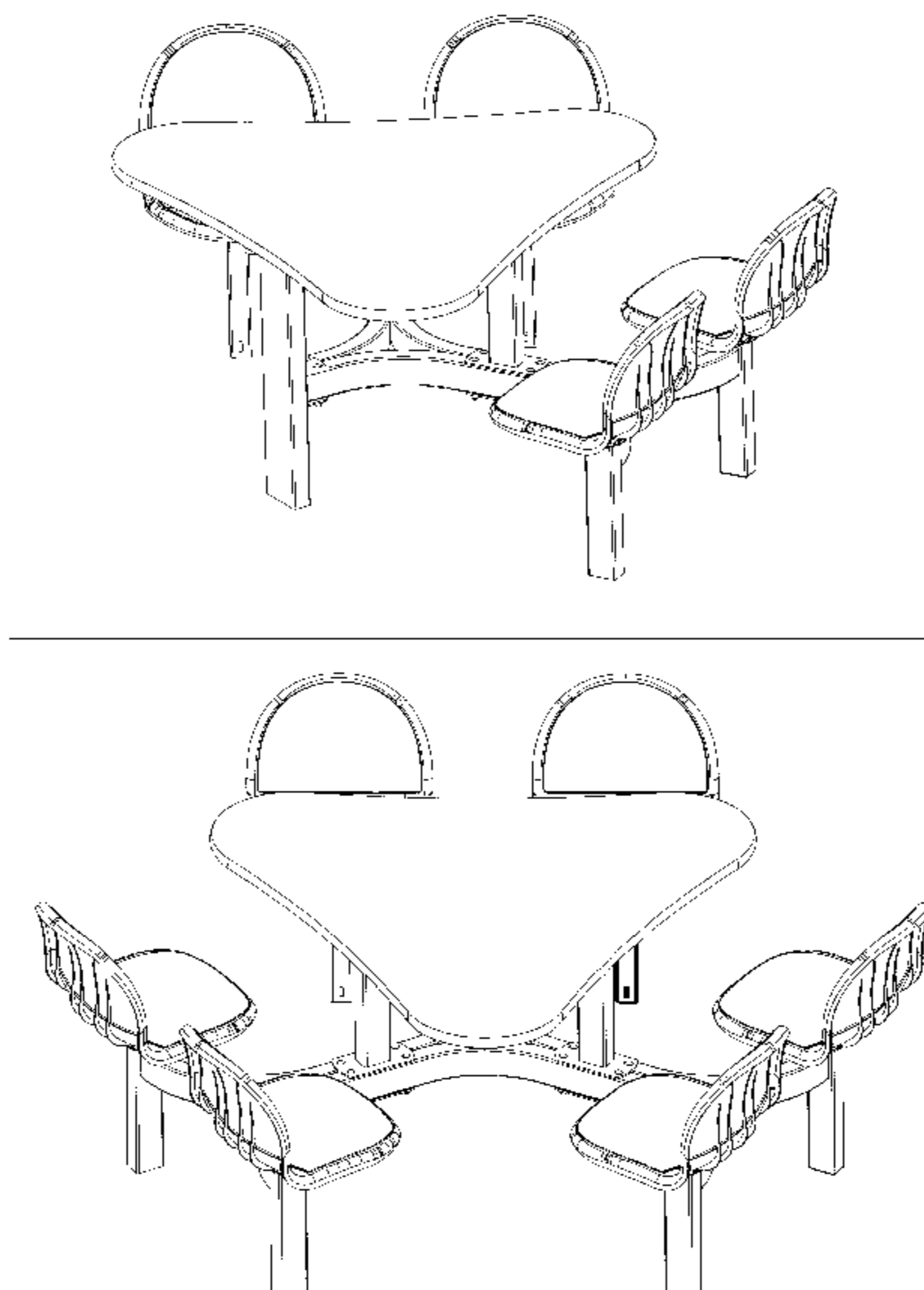

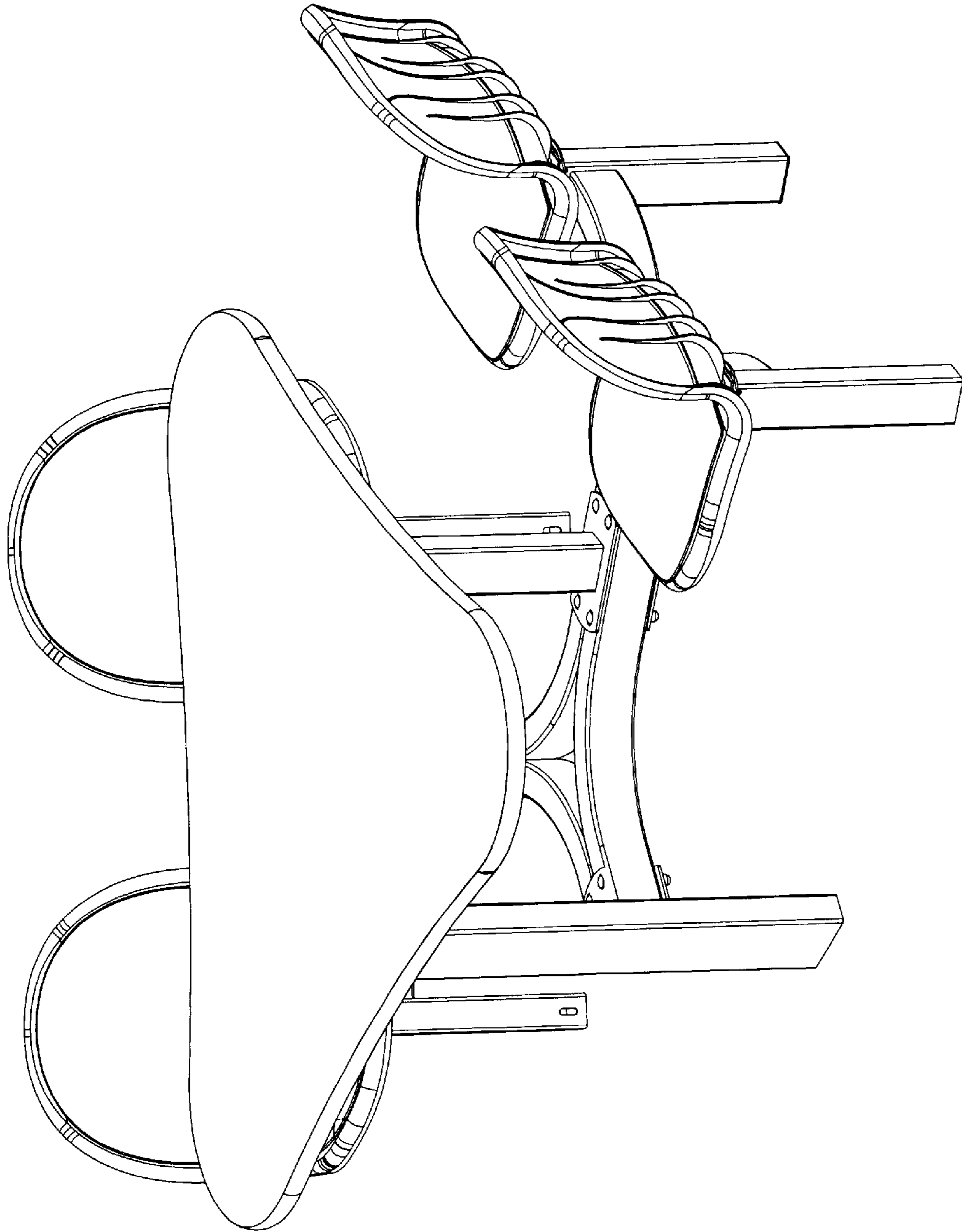

FIG. 1

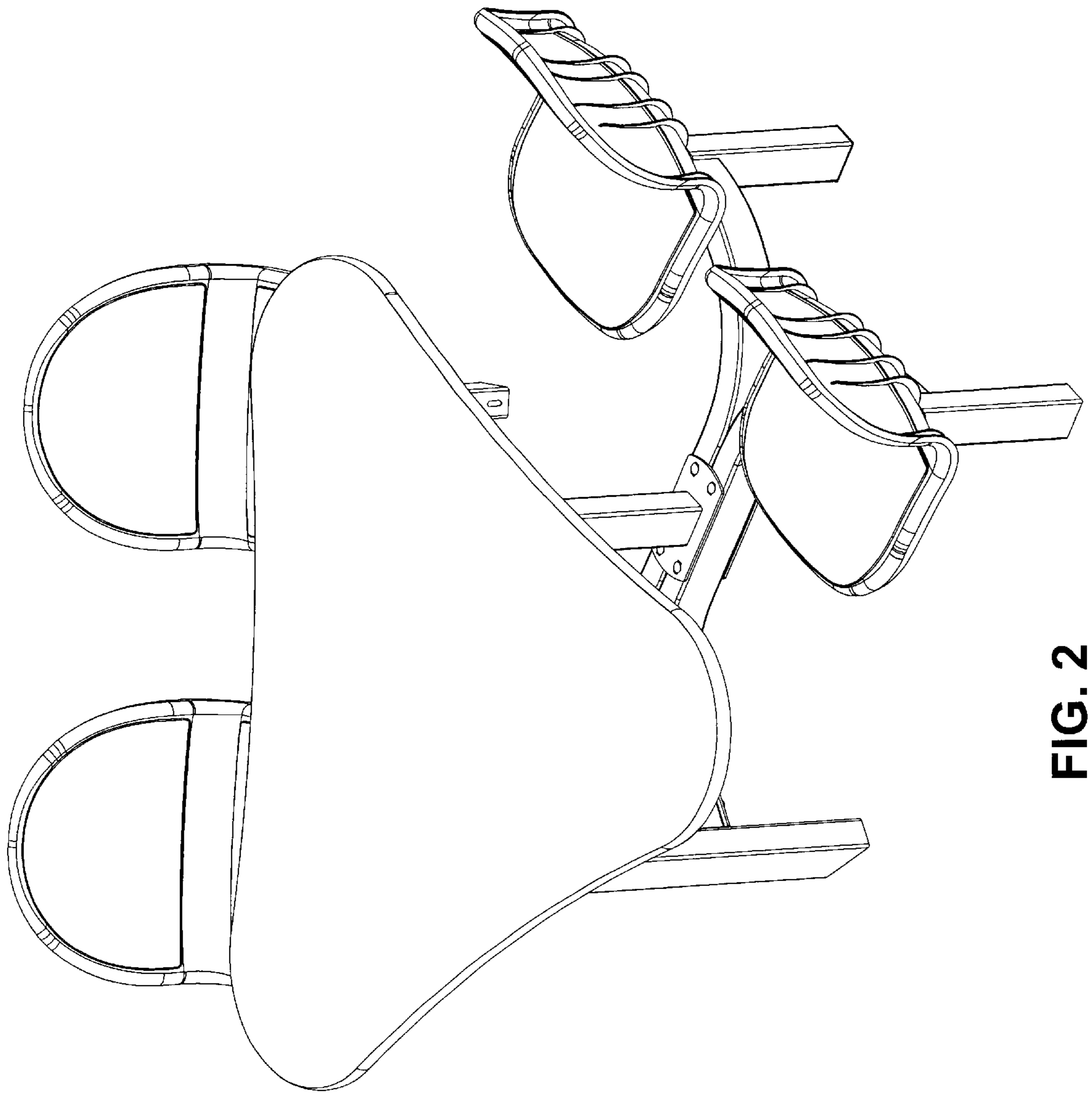

FIG. 2

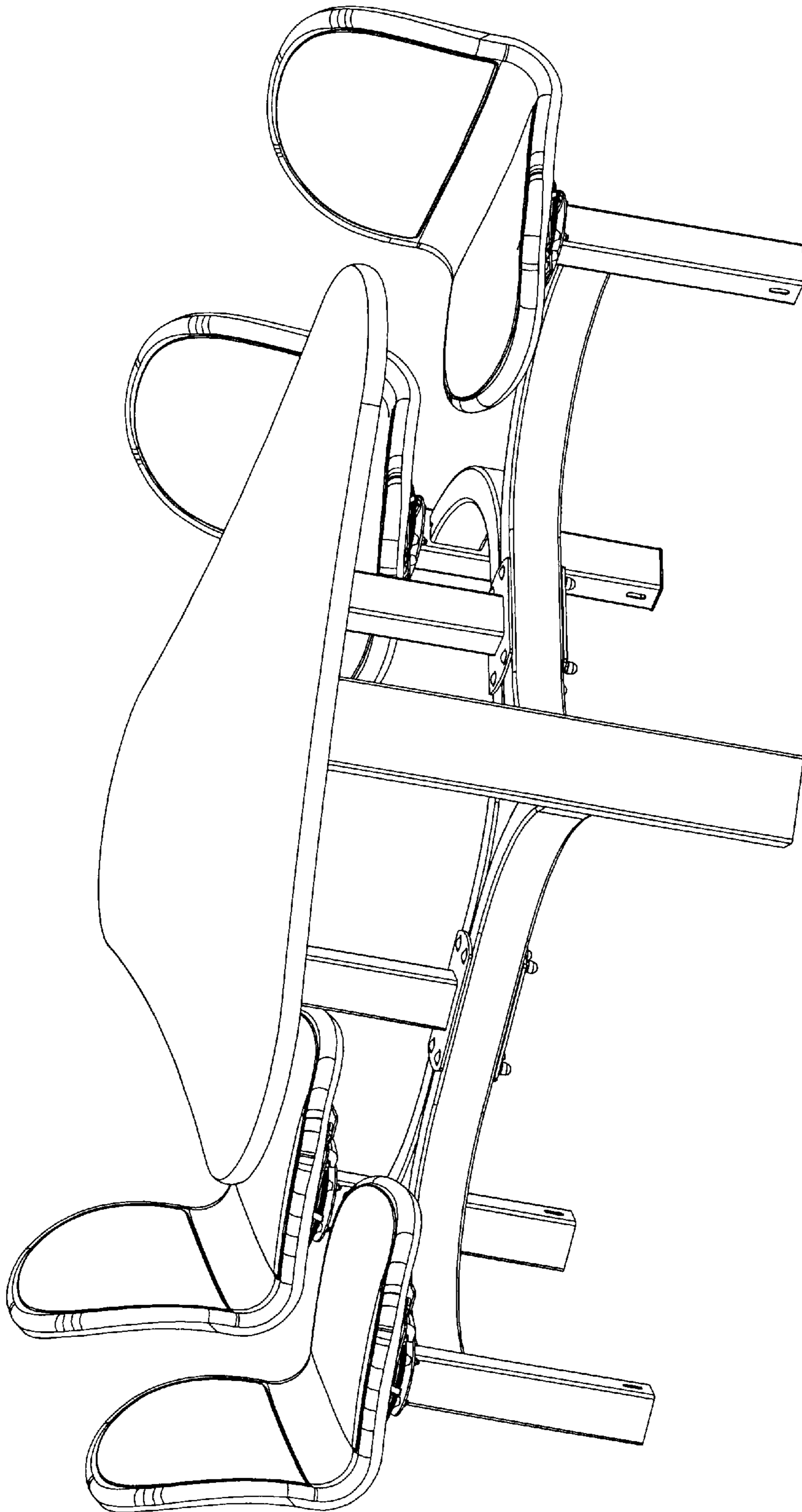

FIG. 3

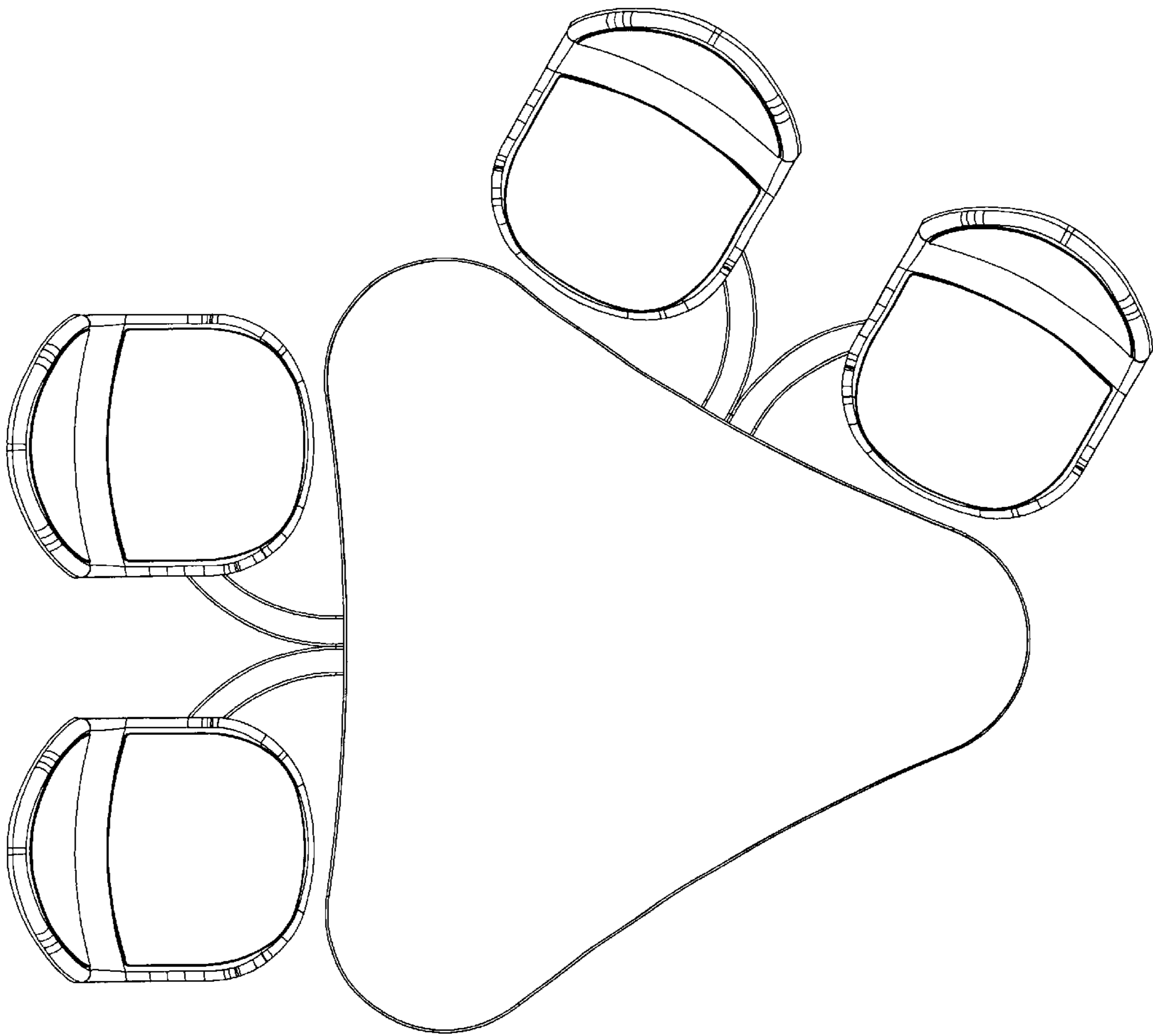

FIG. 4

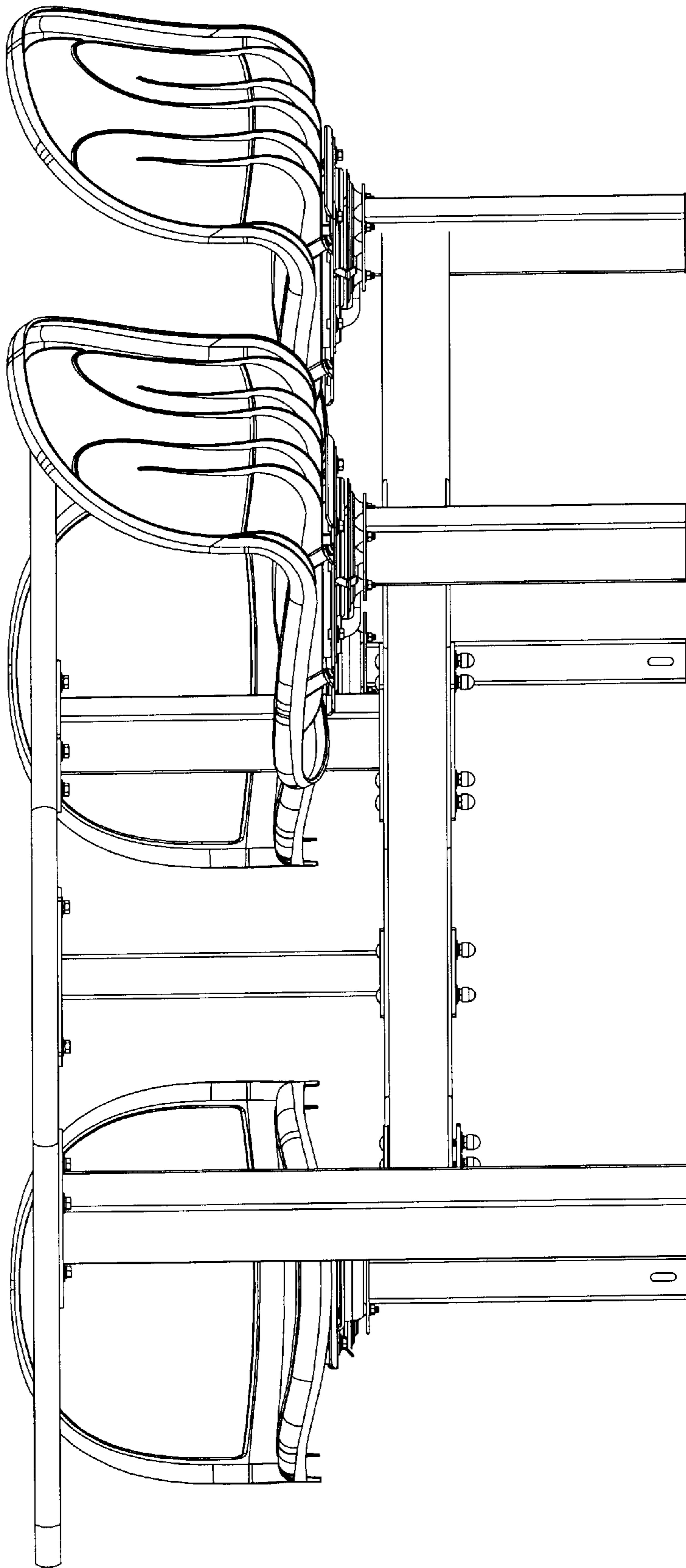

FIG. 5

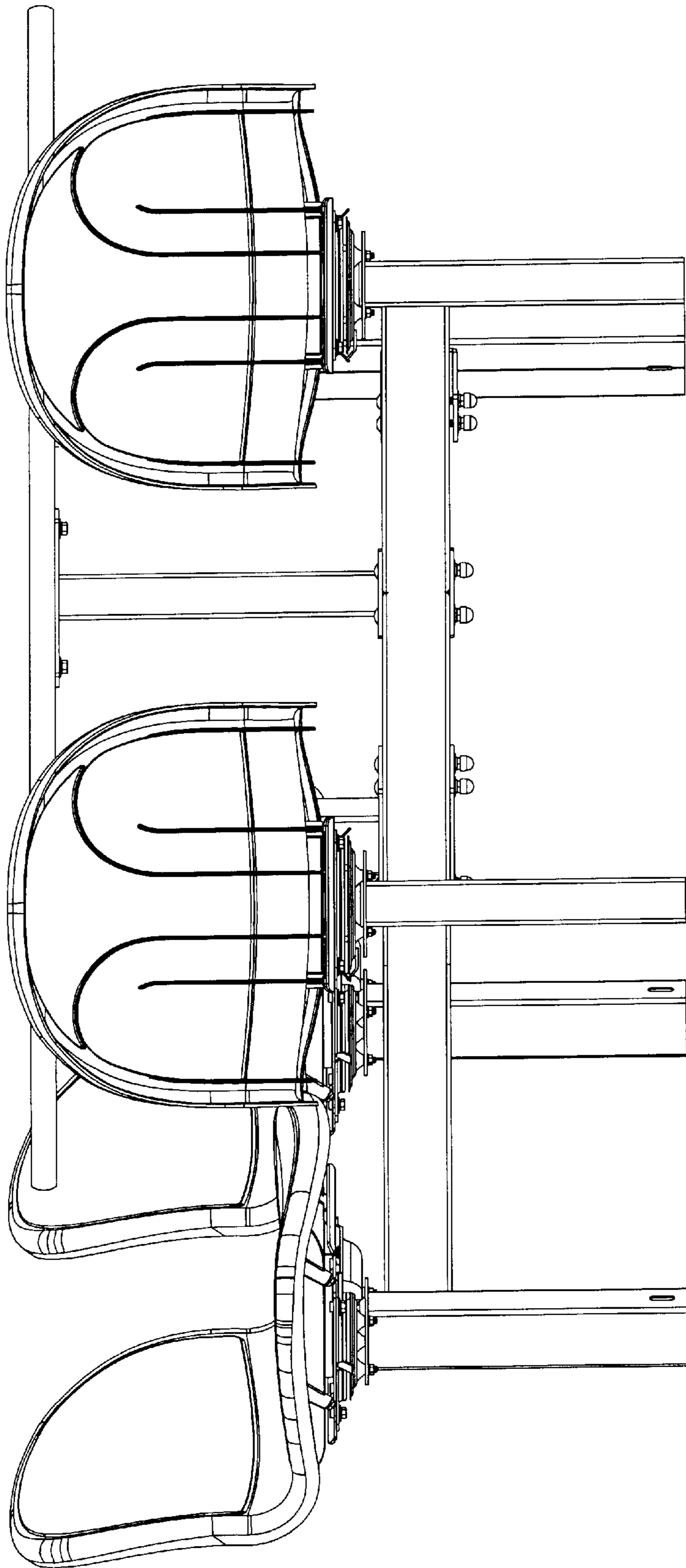

FIG. 6

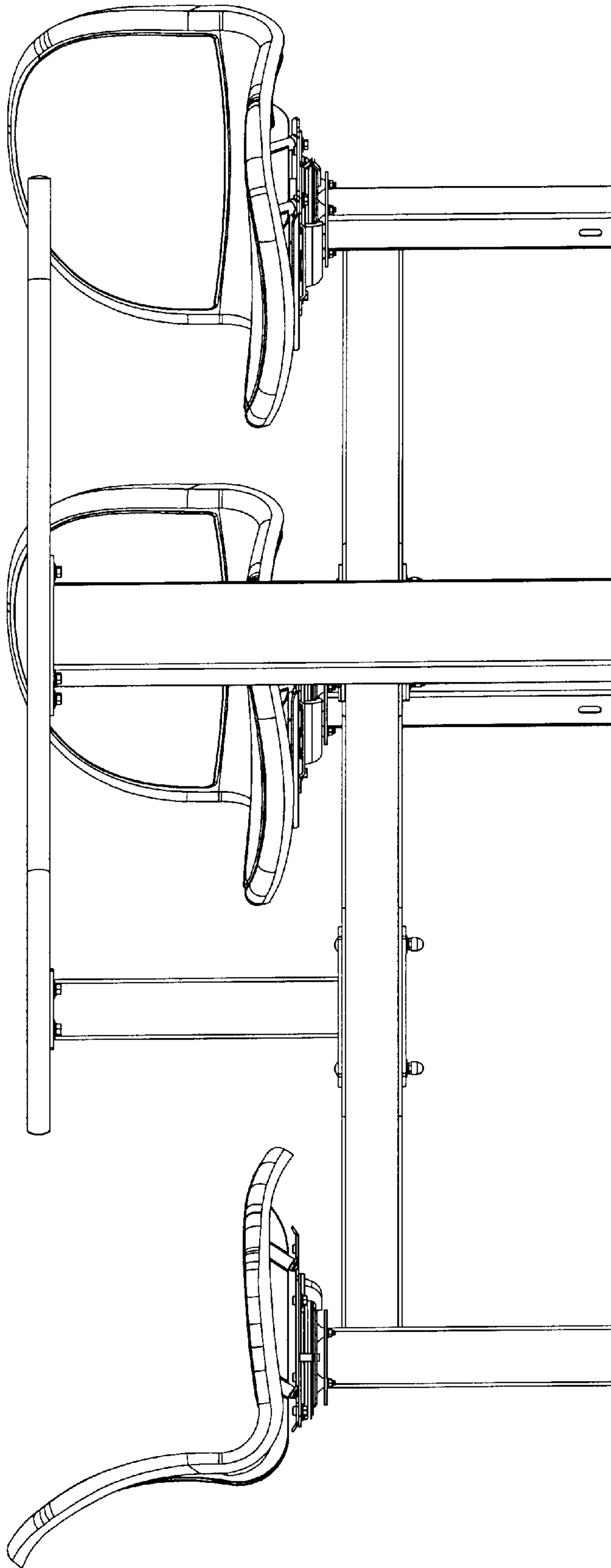

FIG. 7

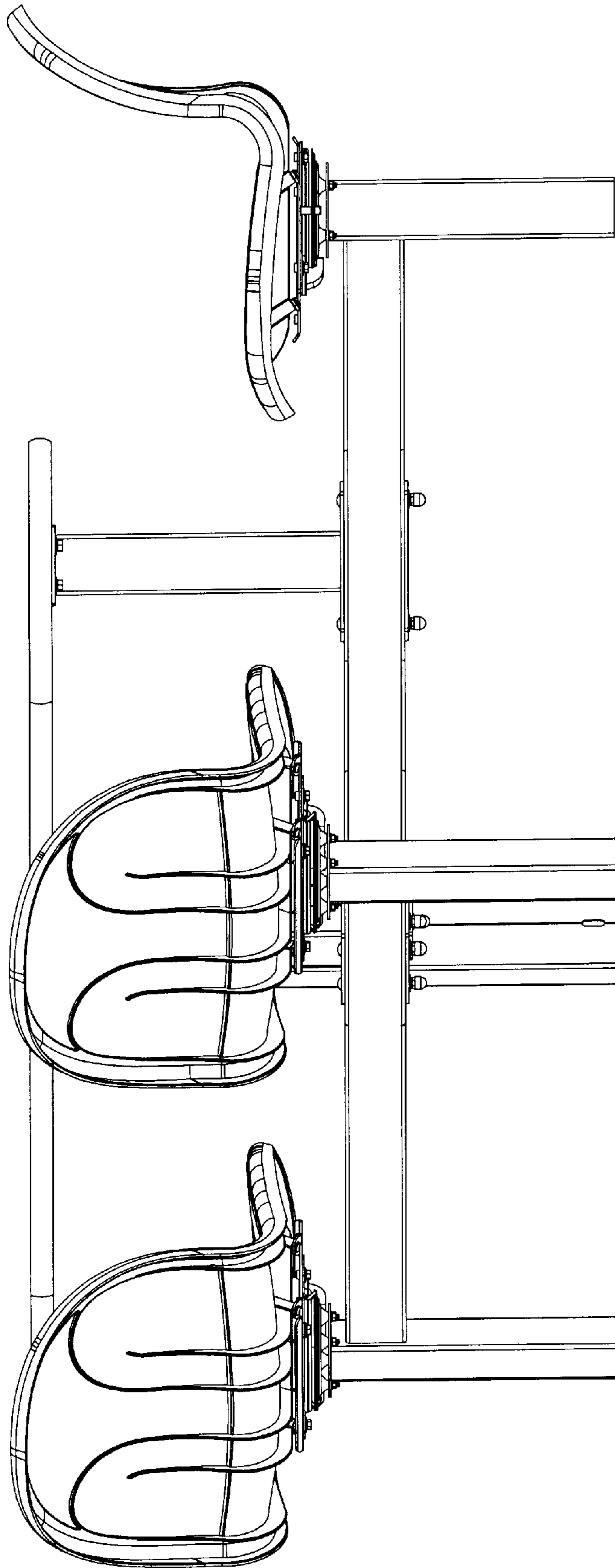

FIG. 8

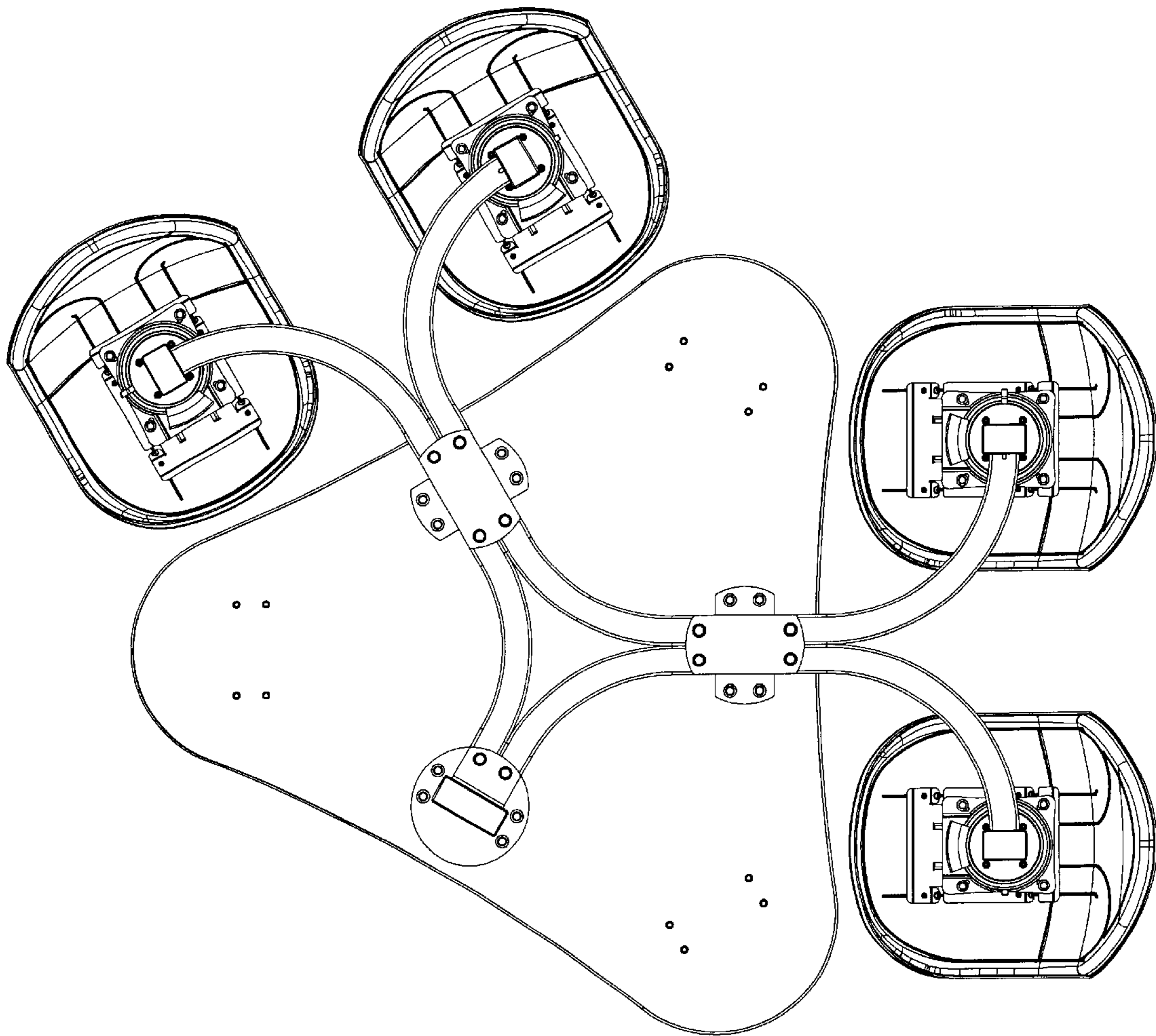

FIG. 9

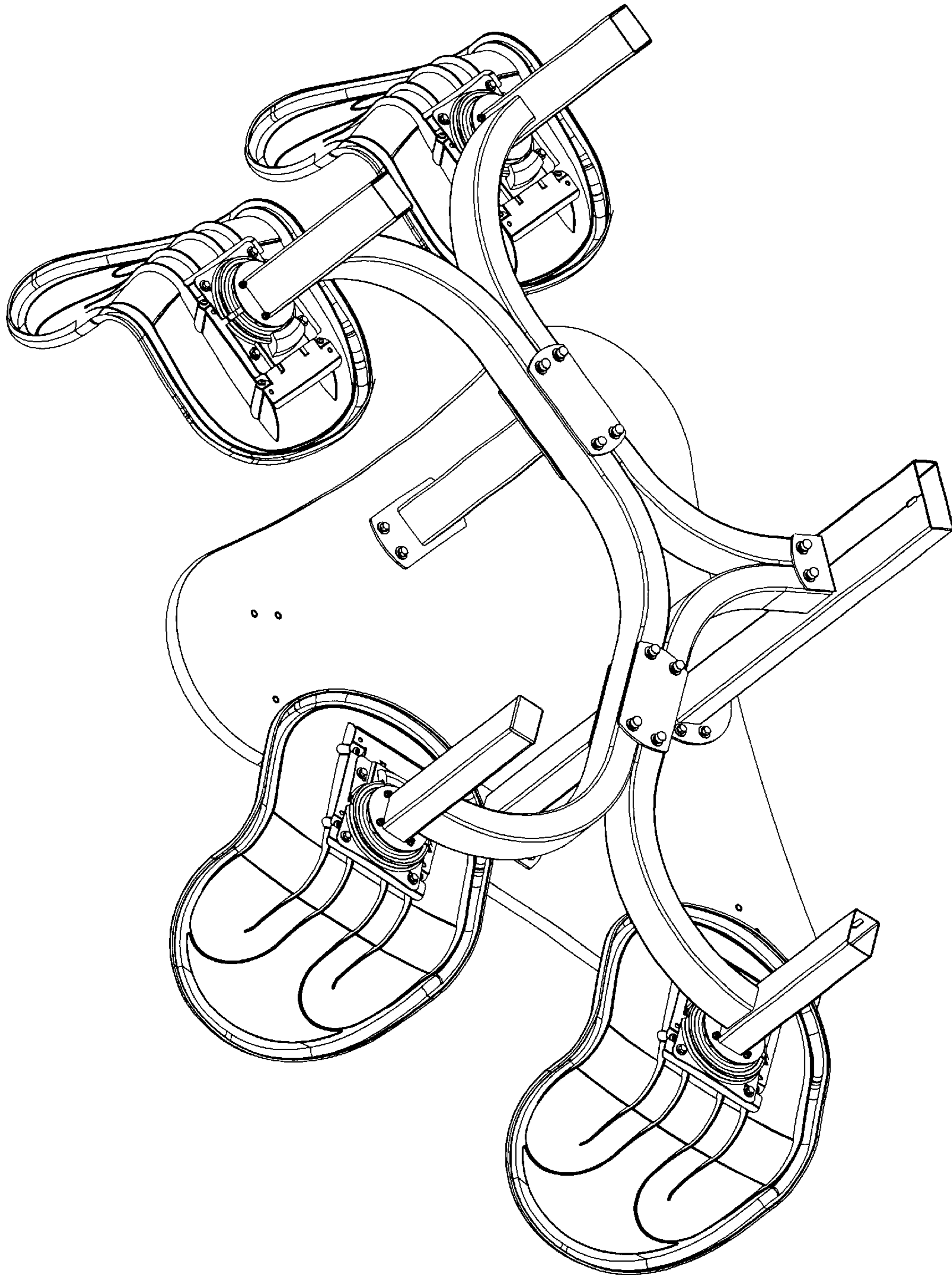

FIG. 10

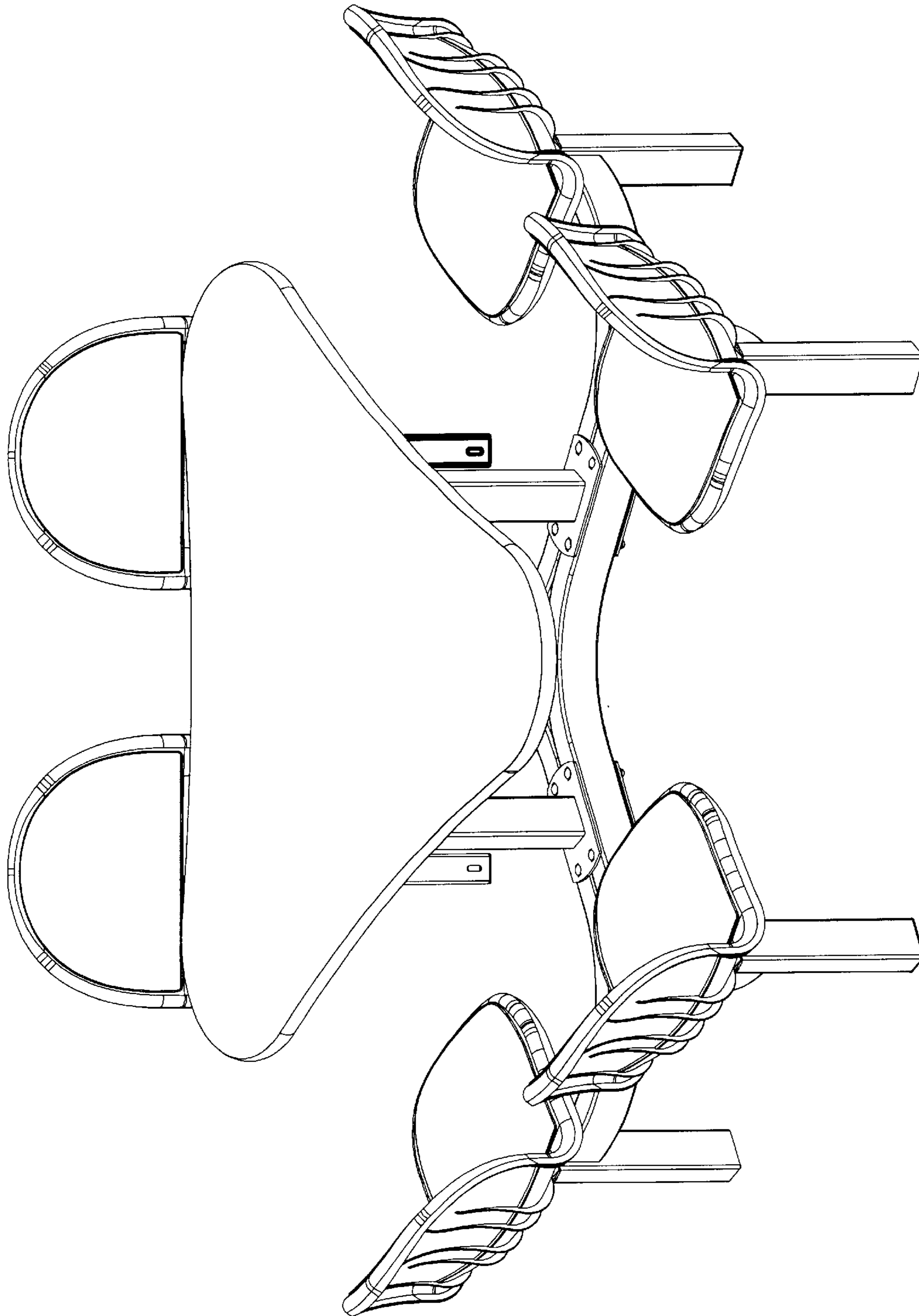

FIG. 11

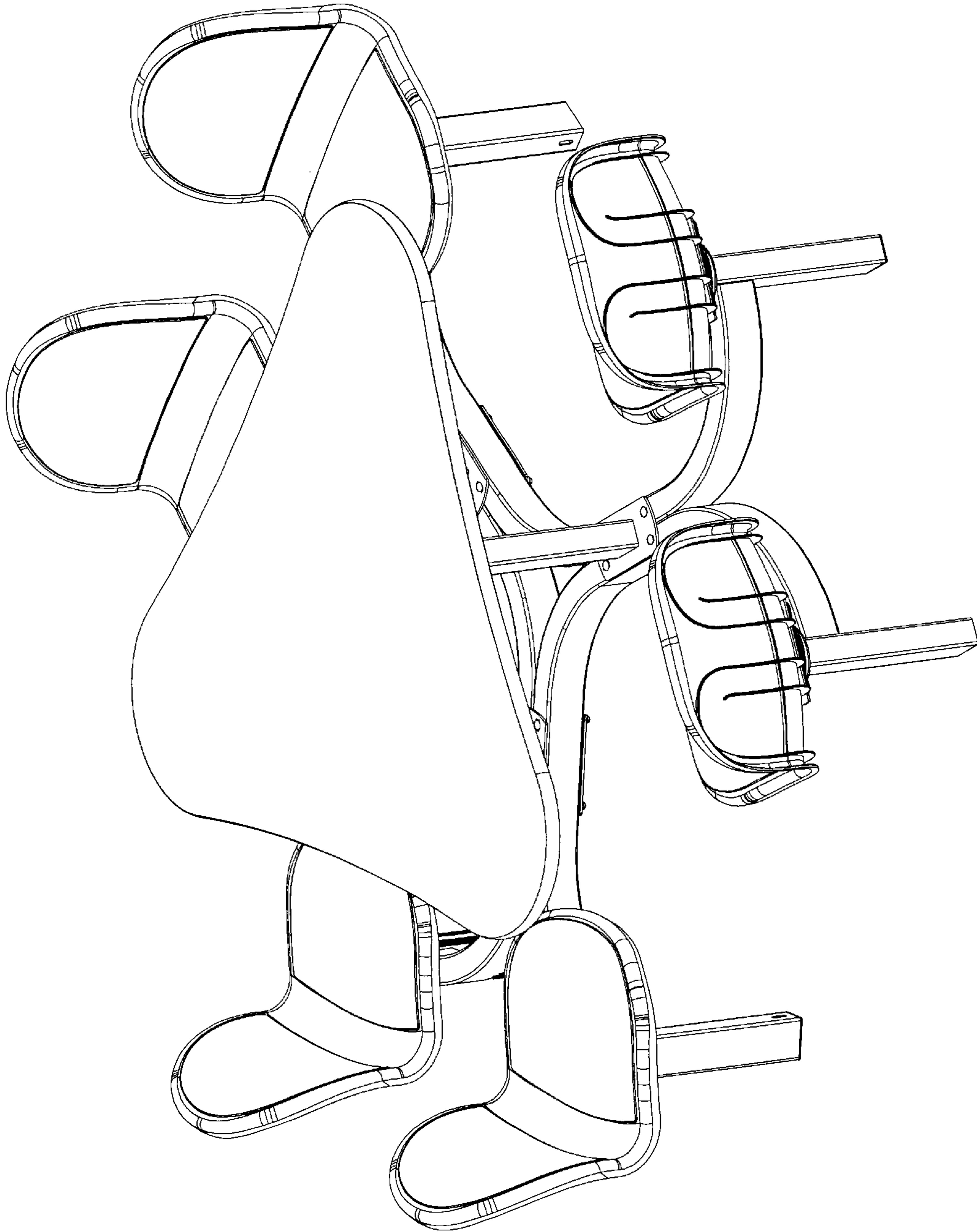

FIG. 12

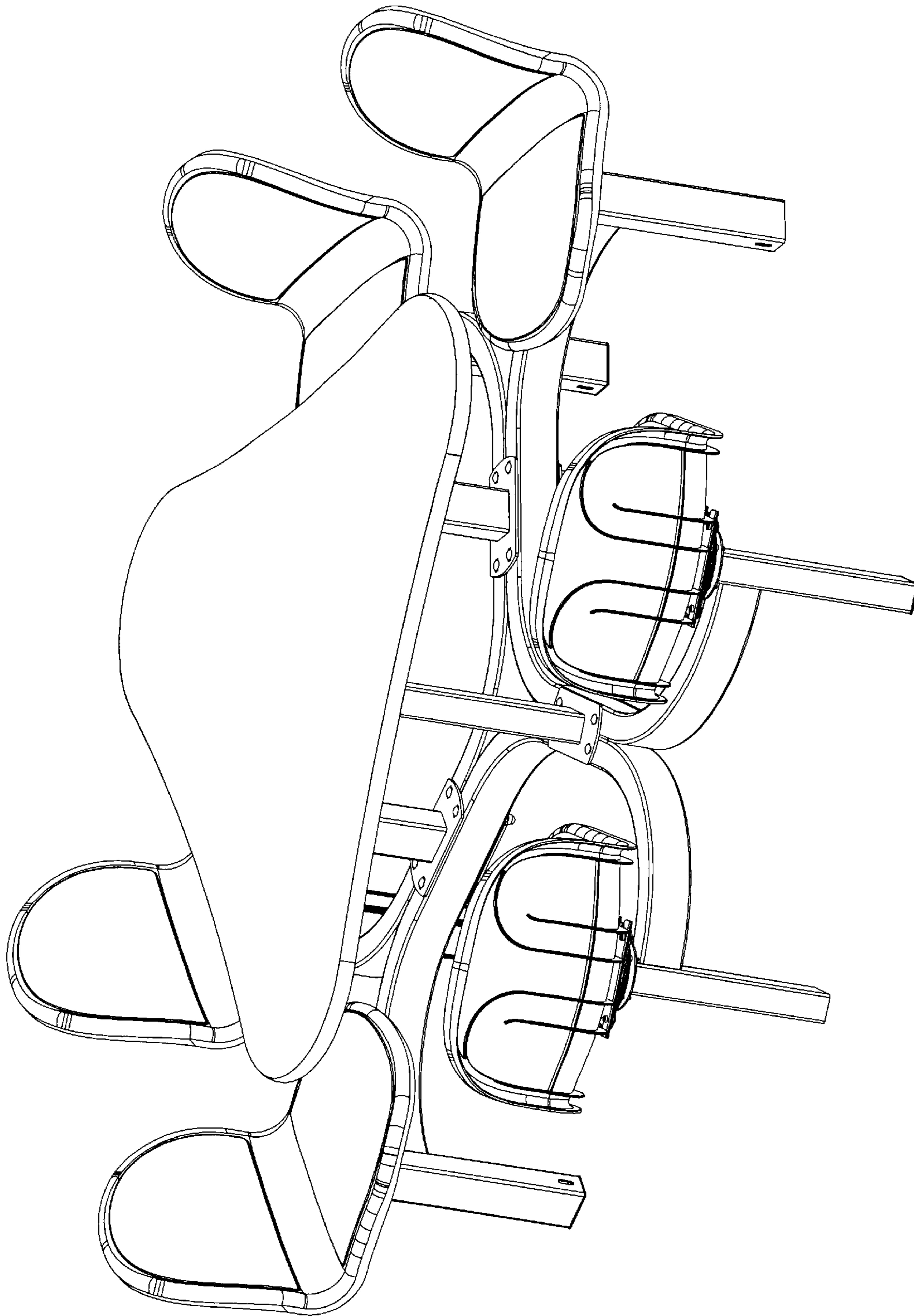

FIG. 13

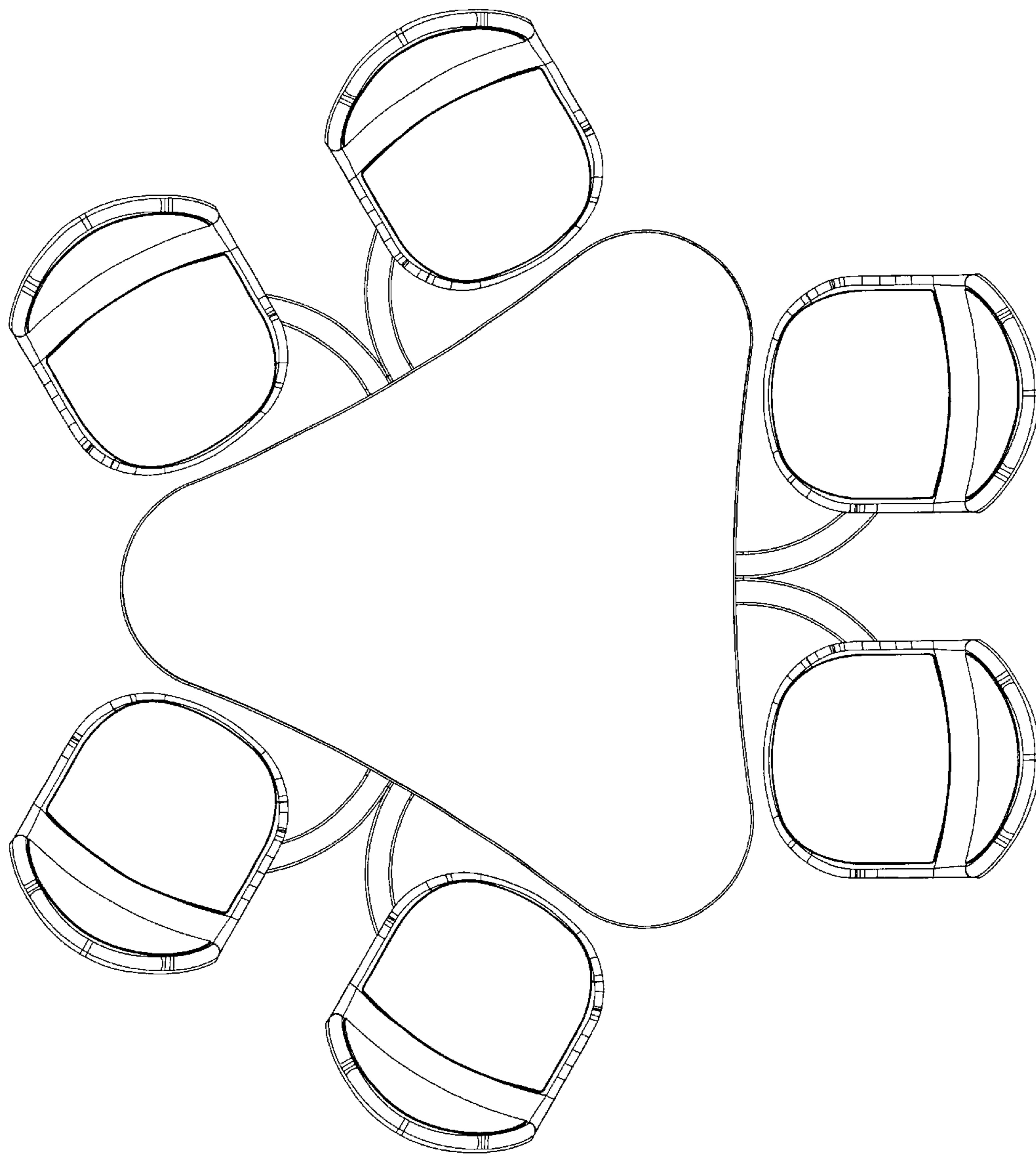

FIG. 14

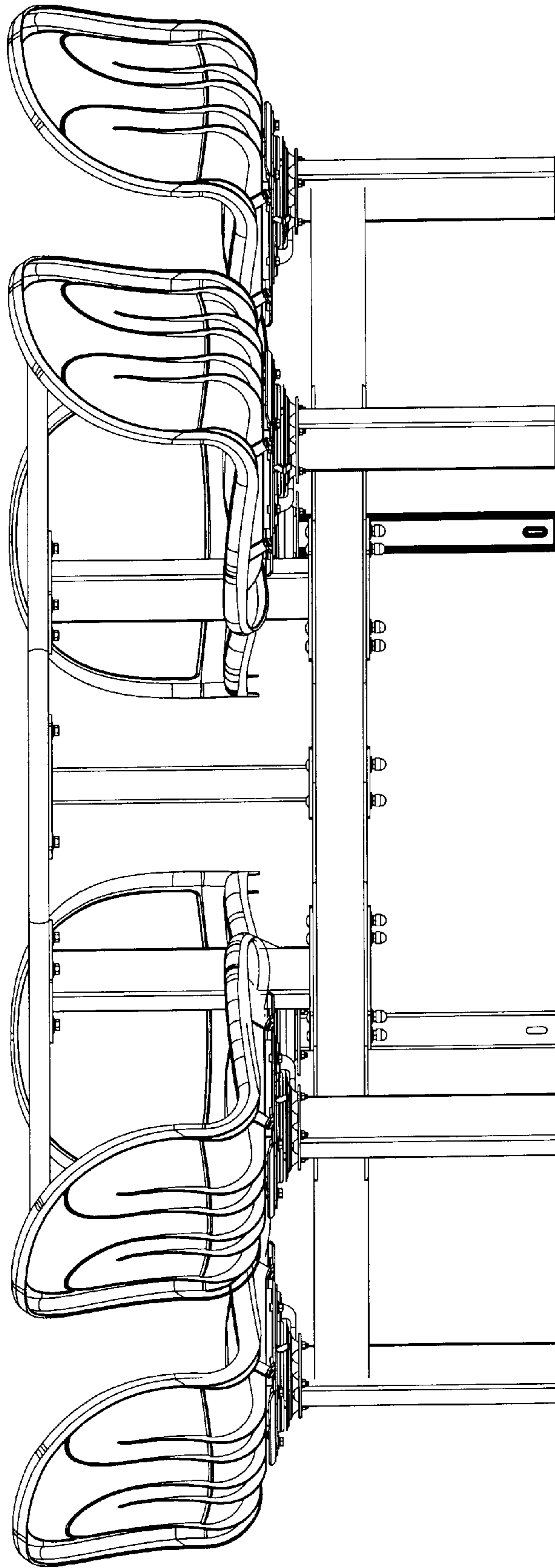

FIG. 15

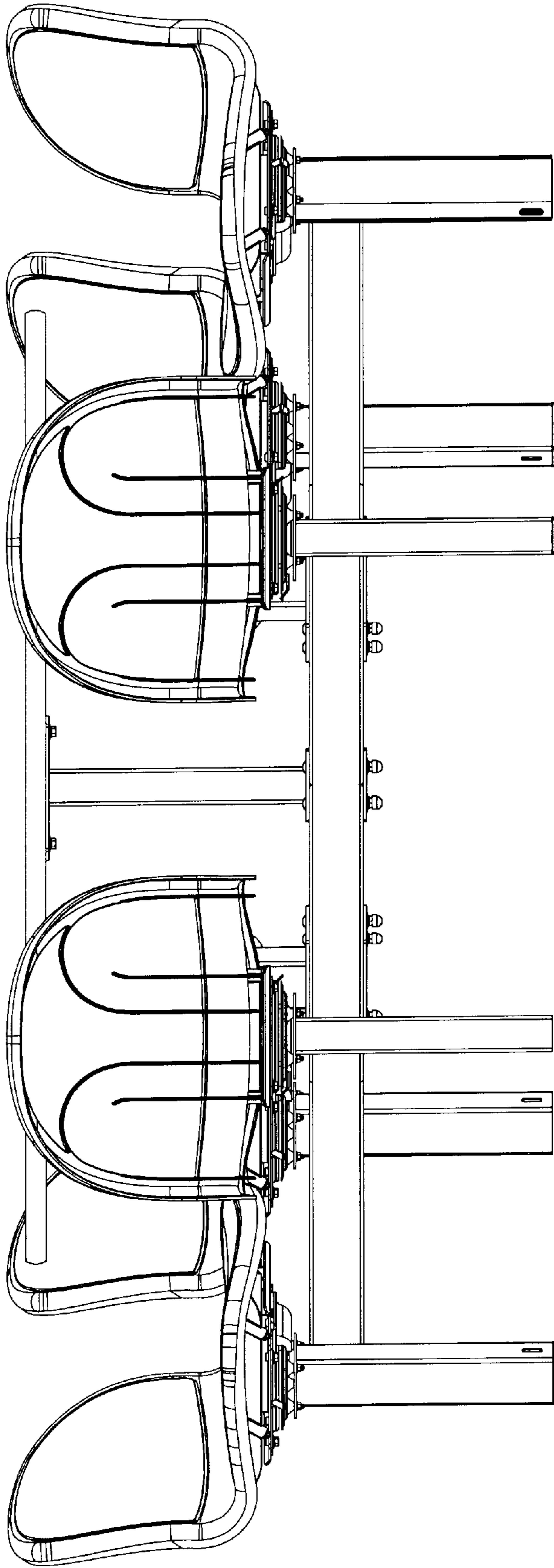

FIG 16

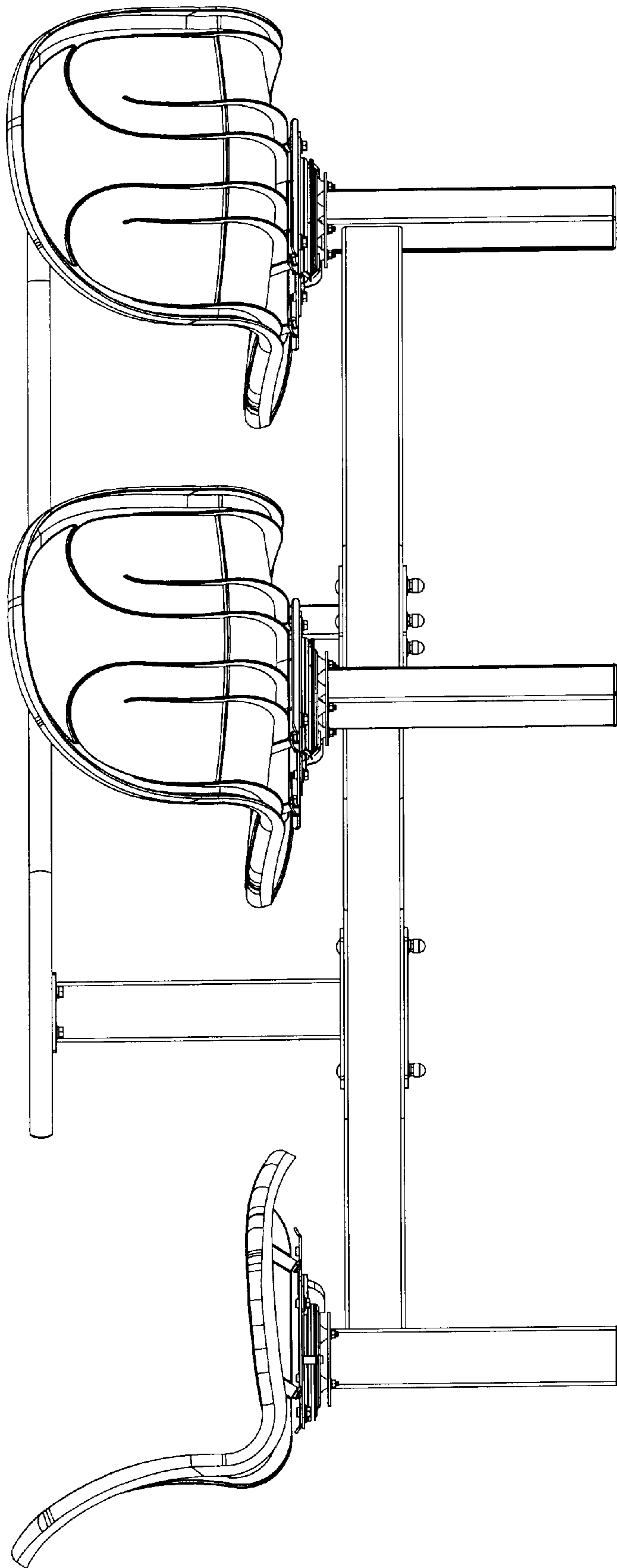

FIG. 17

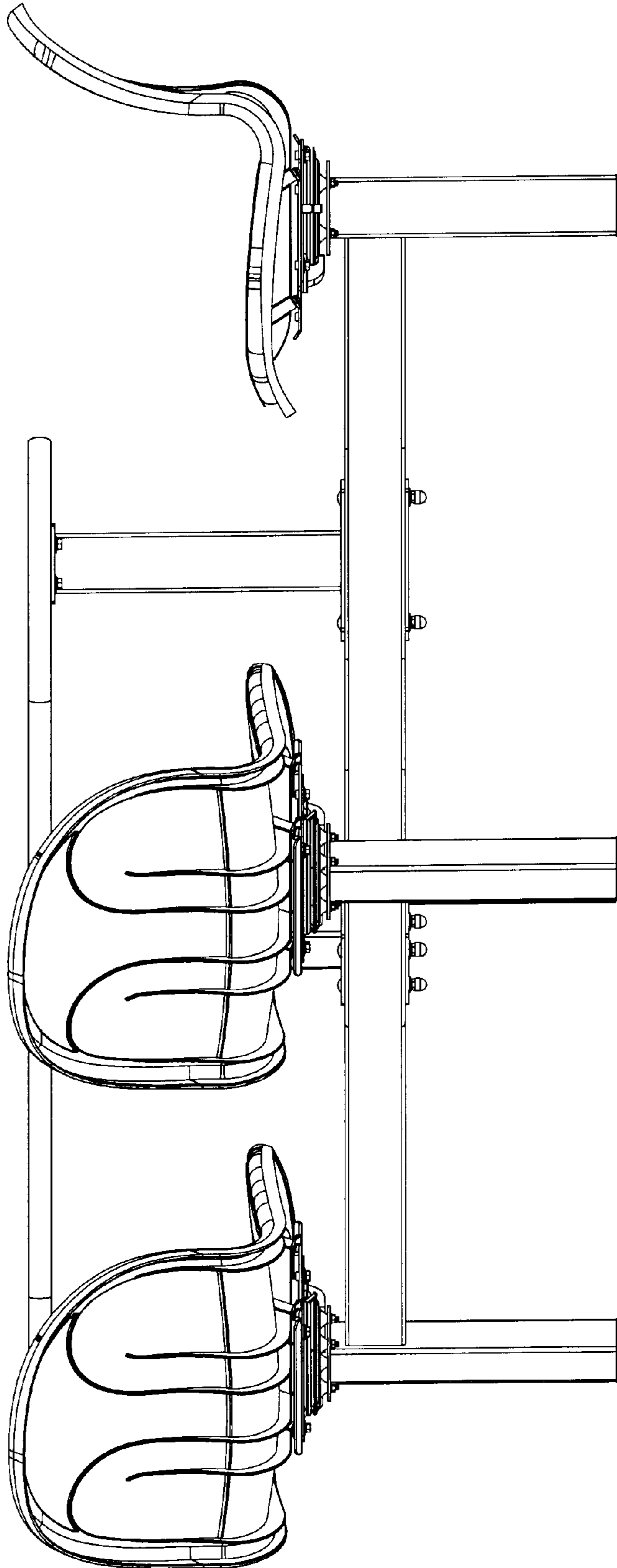

FIG. 18

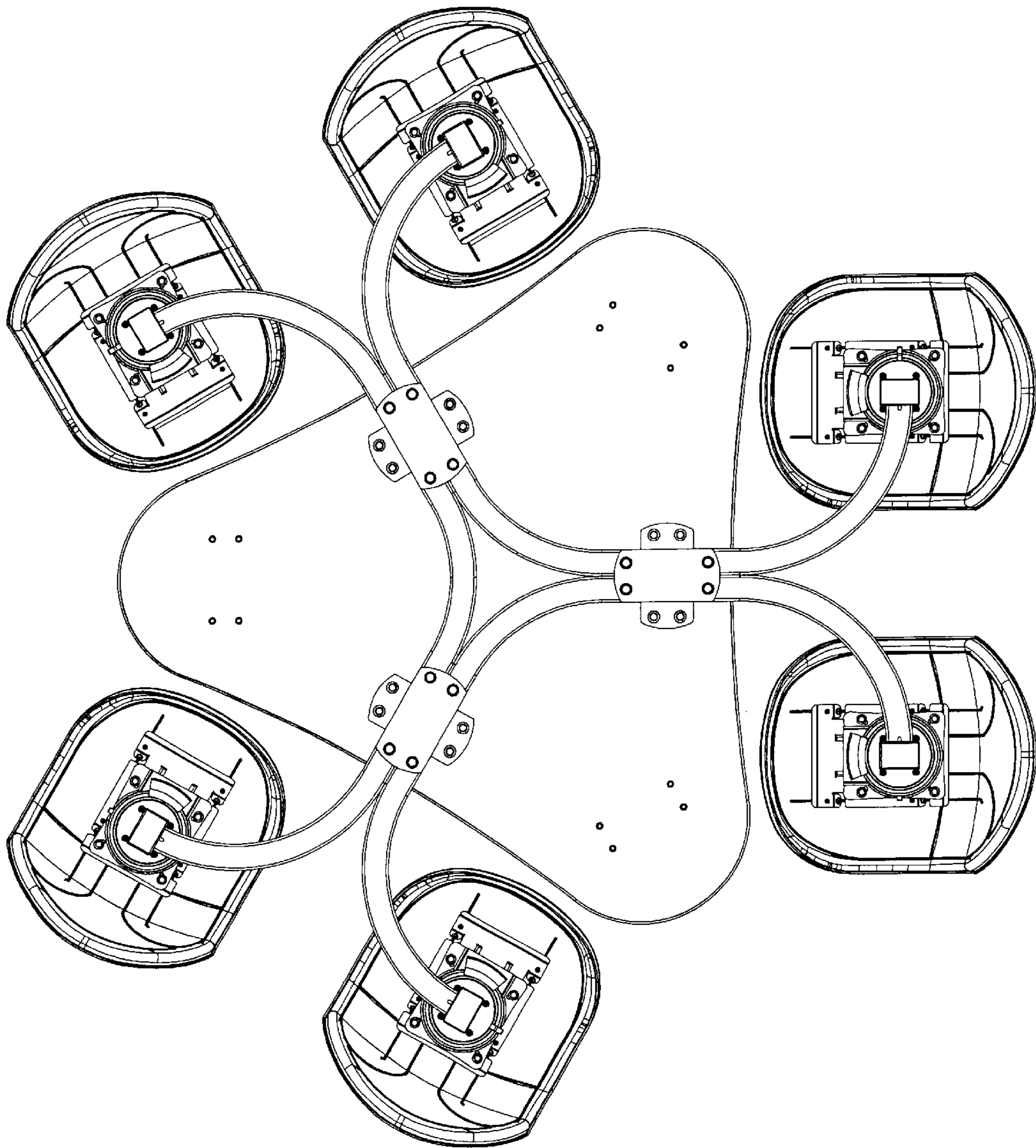

FIG. 19

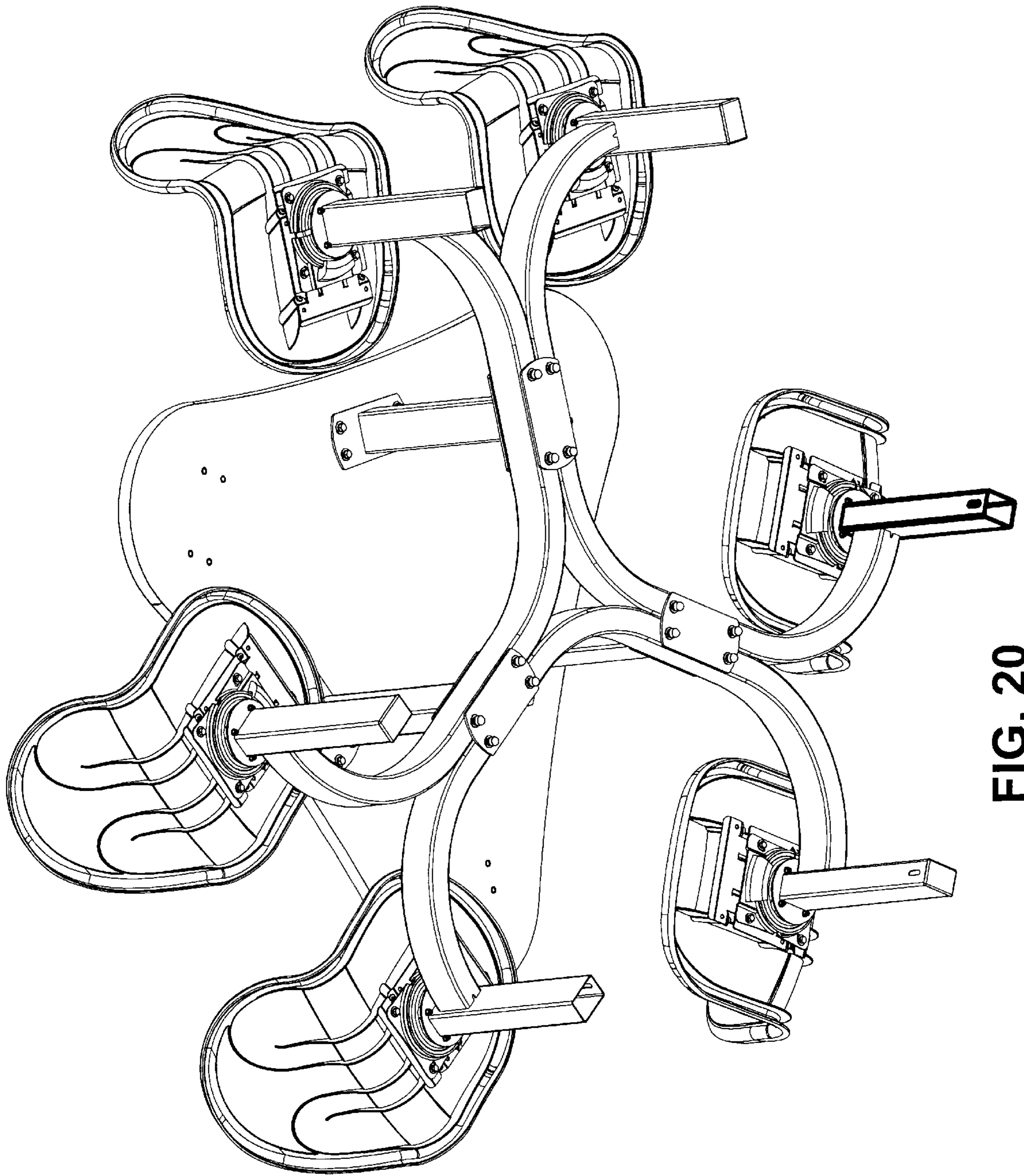

FIG. 20