



US00D478423S

(12) **United States Design Patent**
Mulder et al.

(10) **Patent No.:** **US D478,423 S**

(45) **Date of Patent:** **** *Aug. 19, 2003**

(54) **ELECTRIC TOOTHBRUSH**

(75) Inventors: **Boyd Mulder**, Kirkland, WA (US);
Andreas Loibnegger, Bellevue, WA
(US); **Jamie McCurrach**, Groningen
(NL); **Marc Bommarito**, Renton, WA
(US)

(73) Assignee: **Koninklijke Philips Electronics N.V.**,
Eindhoven (NL)

(*) Notice: This patent is subject to a terminal dis-
claimer.

(**) Term: **14 Years**

(21) Appl. No.: **29/159,934**

(22) Filed: **Apr. 30, 2002**

(51) **LOC (7) Cl.** **04-02**

(52) **U.S. Cl.** **D4/101**

(58) **Field of Search** D4/101, 104-112;
15/167.1, 143.1, 22.1, 105-106

(56) **References Cited**

U.S. PATENT DOCUMENTS

- D334,473 S * 4/1993 Volpenhein et al. D4/104
- 5,383,242 A * 1/1995 Bigler et al. 15/22.1
- 5,511,275 A * 4/1996 Volpenhein et al. 15/167.1

- D400,713 S * 11/1998 Solanki D4/104
- D411,769 S * 7/1999 Wright D4/101
- D440,767 S * 4/2001 Moskovich et al. D4/104
- D458,028 S * 6/2002 McCurrach D4/101

* cited by examiner

Primary Examiner—Holly Baynham

(74) *Attorney, Agent, or Firm*—Ernestine C. Bartlett

(57) **CLAIM**

The ornamental design for a electric toothbrush, as shown.

DESCRIPTION

FIG. 1 is a perspective view of an assembled toothbrush;
 FIG. 2 is a front view thereof;
 FIG. 3 is a rear view thereof;
 FIG. 4 is a left side view thereof;
 FIG. 5 is a top view thereof;
 FIG. 6 is a bottom view thereof;
 FIG. 7 is a perspective view of a disassembled toothbrush;
 FIG. 8 is a front view of head and body disassembled;
 FIG. 9 is a back view of head and body disassembled;
 FIG. 10 is a left view of head and body disassembled;
 FIG. 11 is a right side view of head and body disassembled;
 FIG. 12 is a top view of head and body disassembled; and,
 FIG. 13 is a bottom view of head and body disassembled.

1 Claim, 11 Drawing Sheets

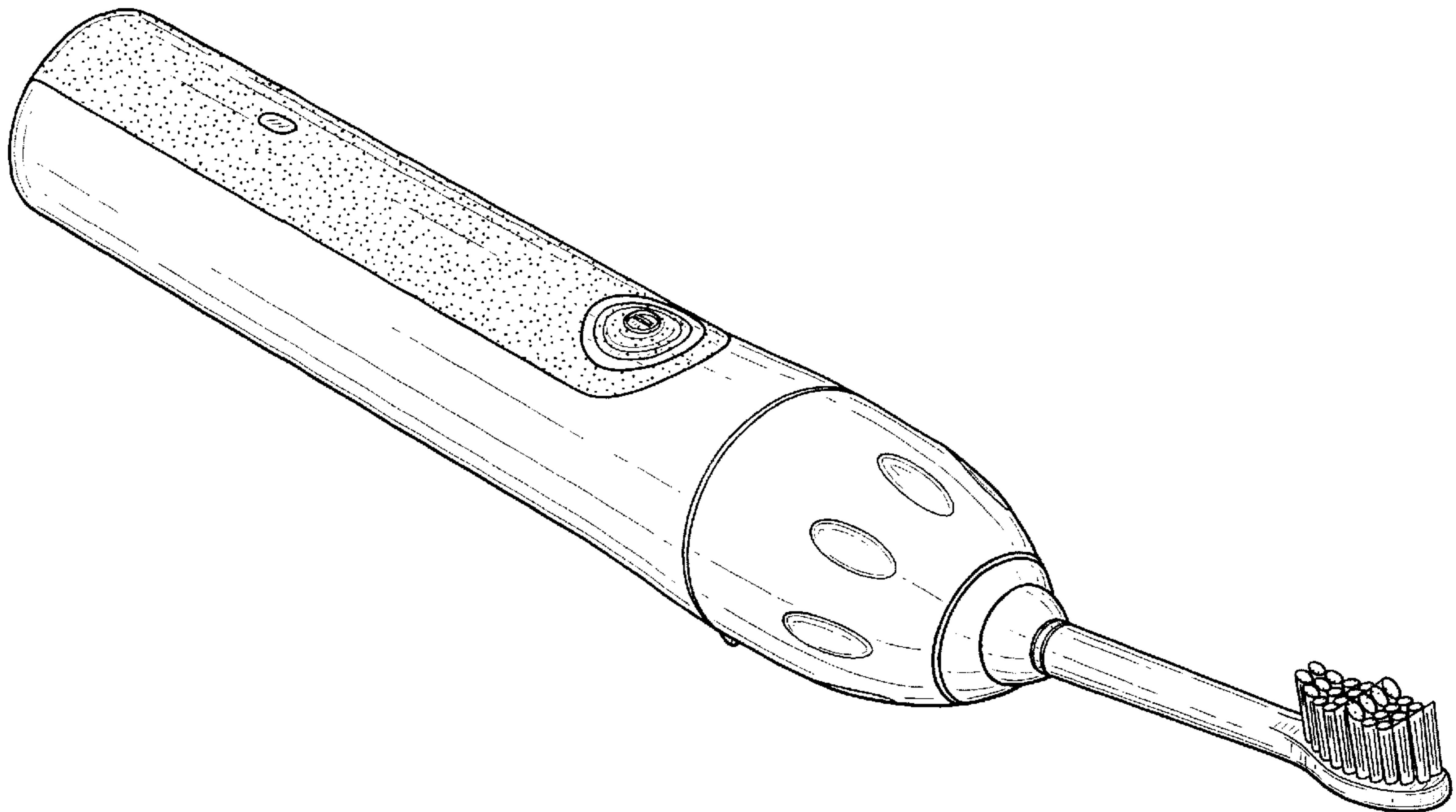

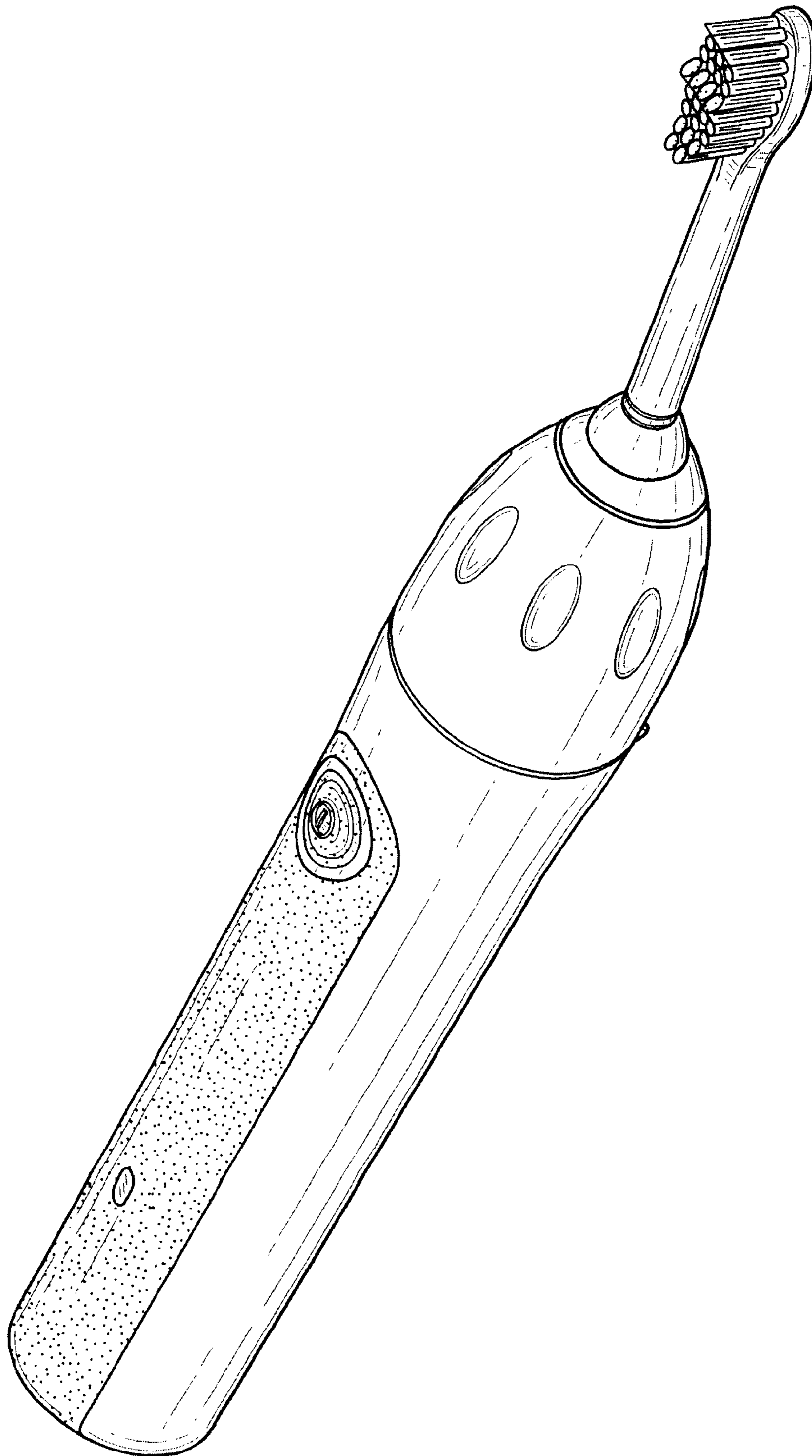

FIG. 1

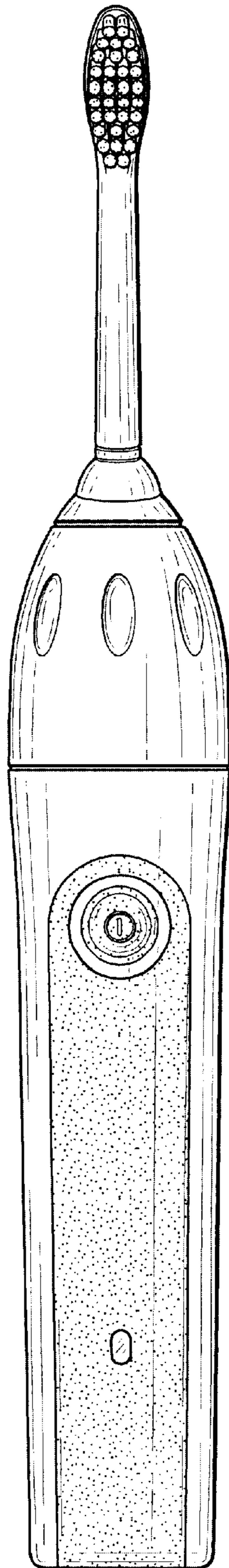

FIG. 2

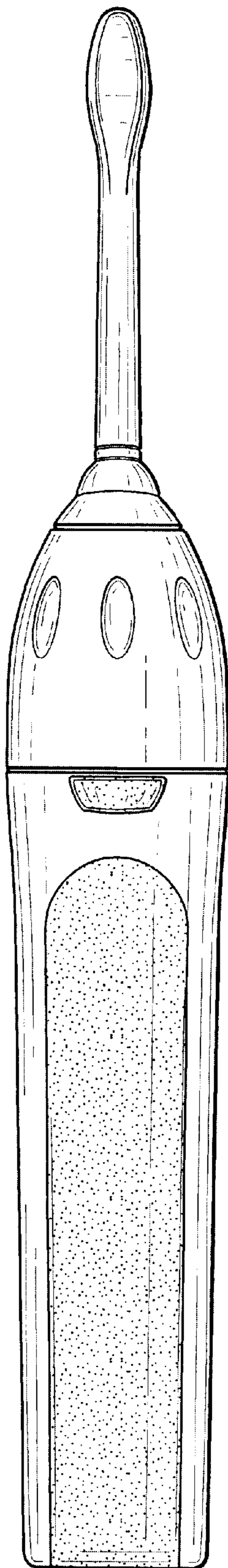

FIG. 3

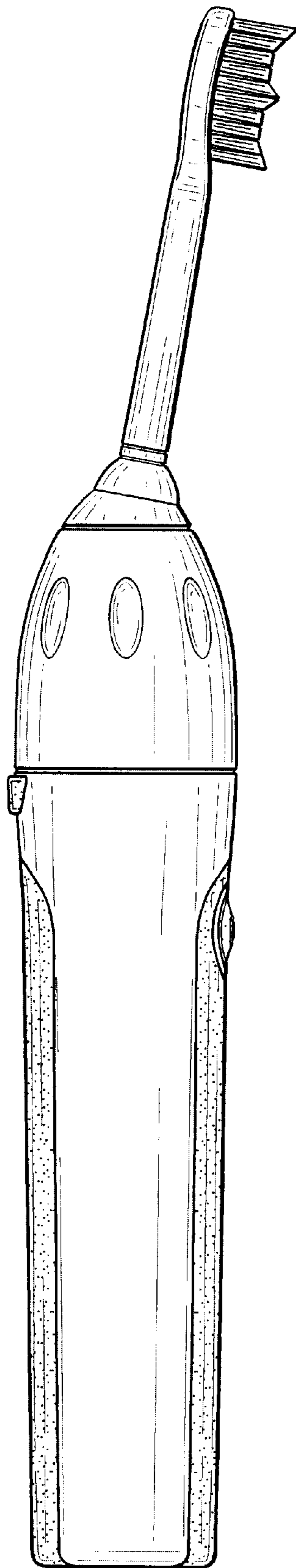

FIG. 4

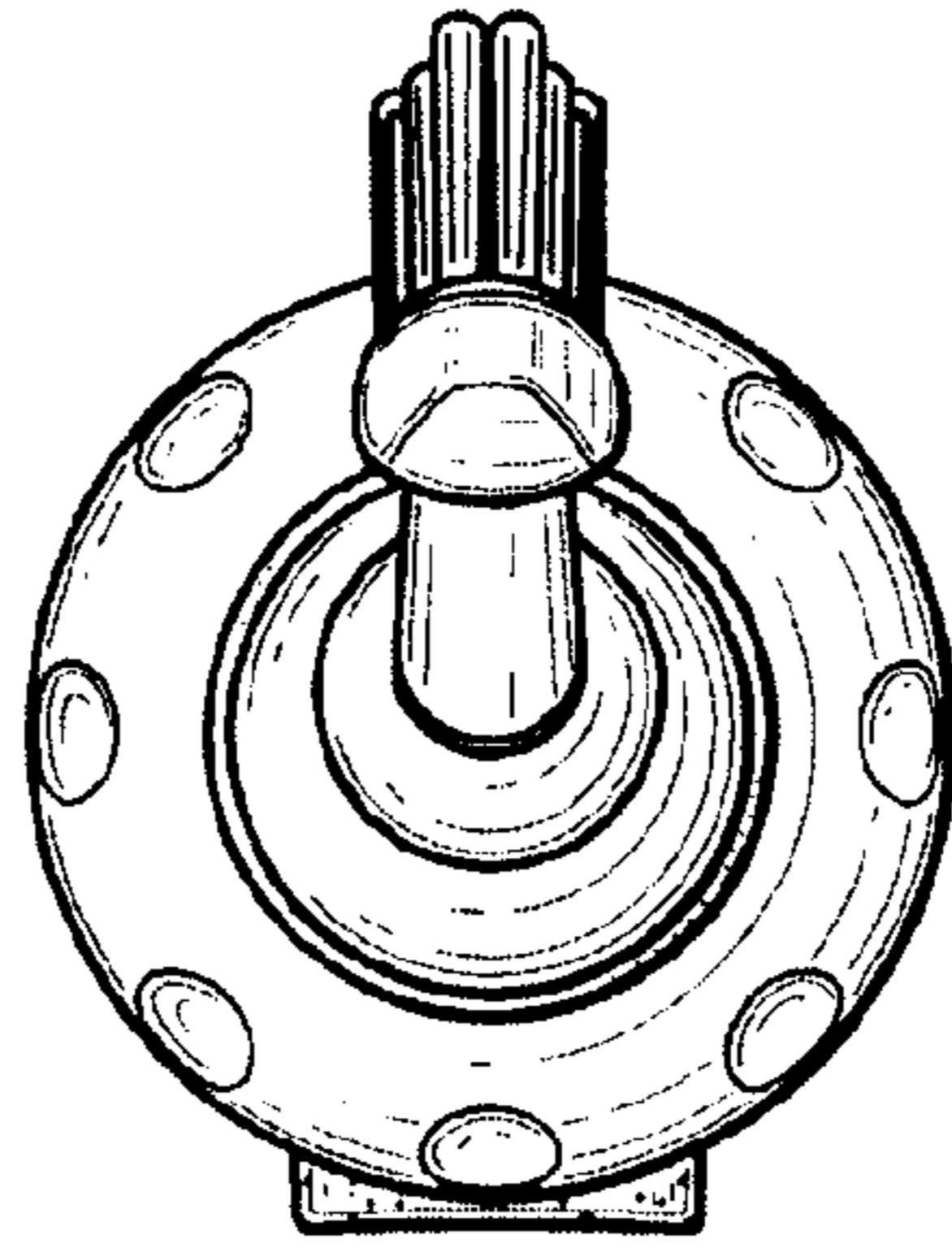

FIG. 5

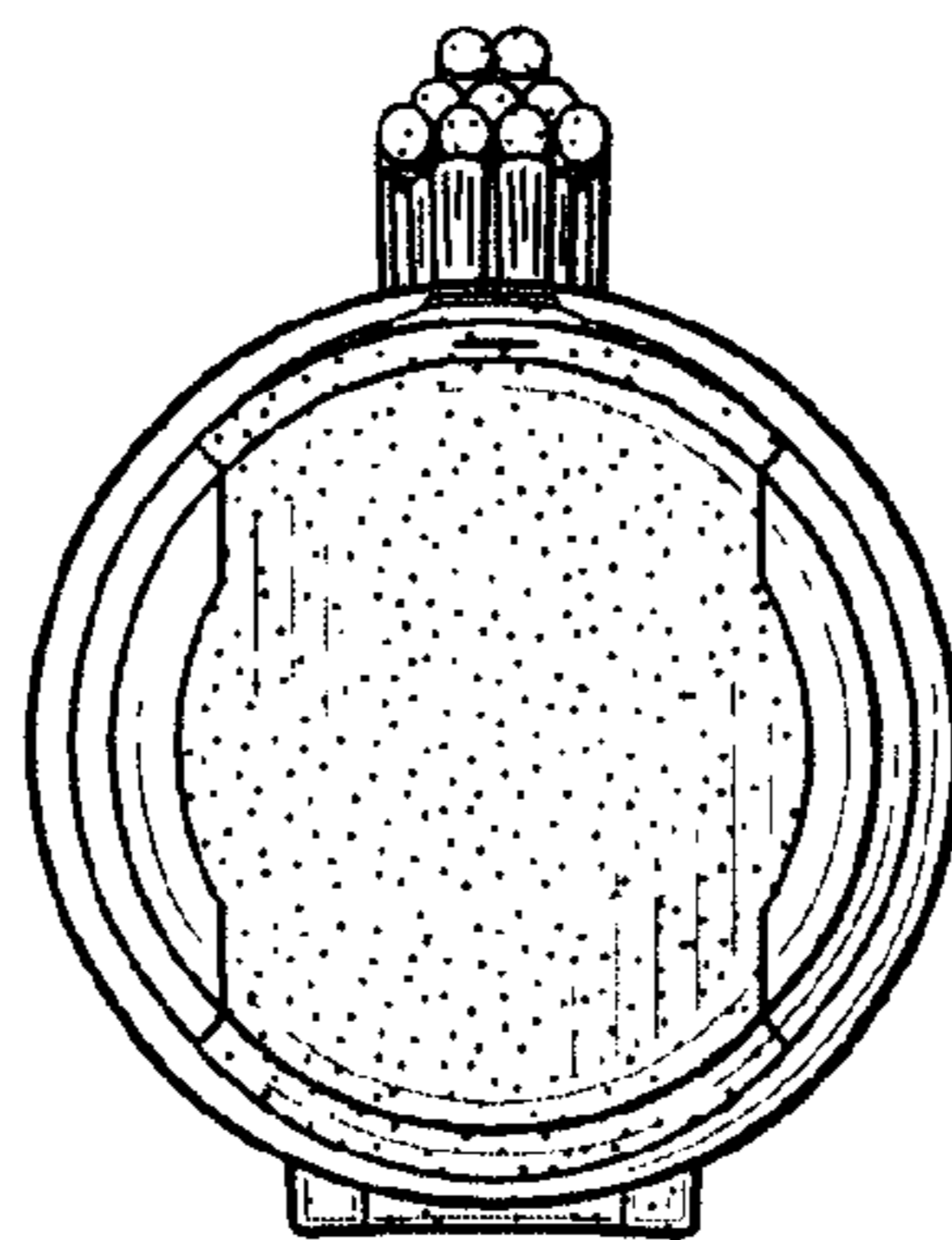

FIG. 6

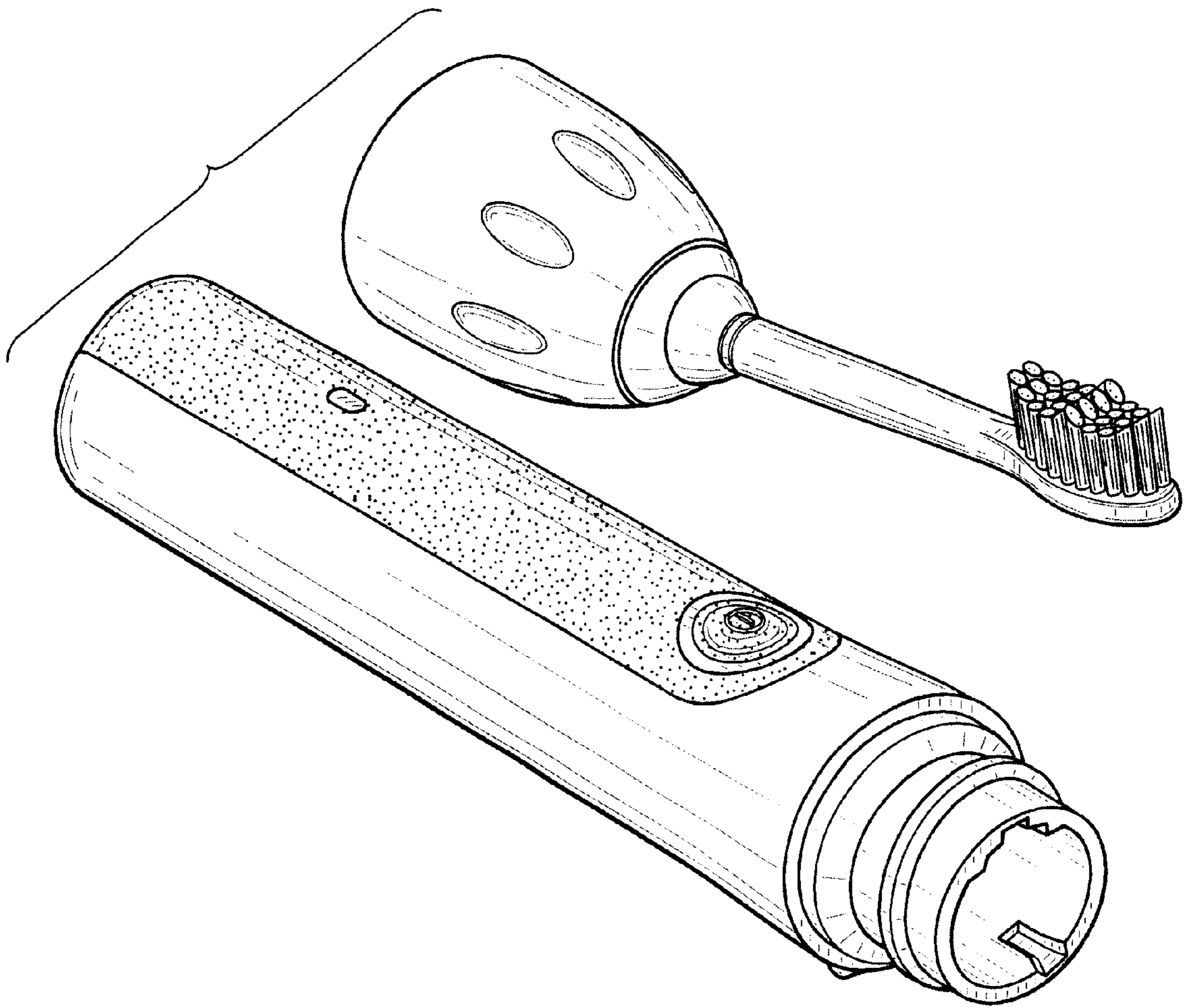

FIG. 7

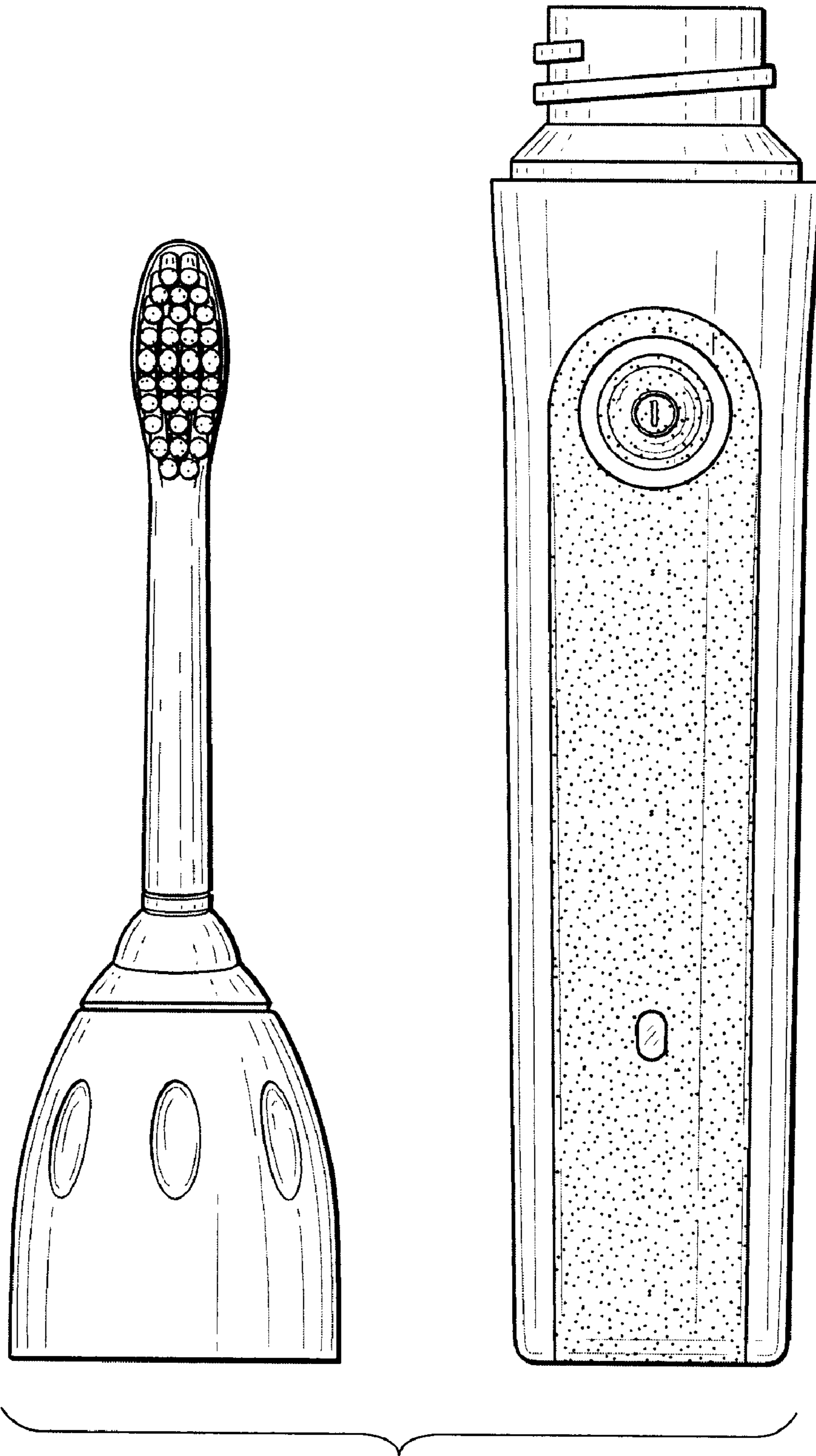

FIG. 8

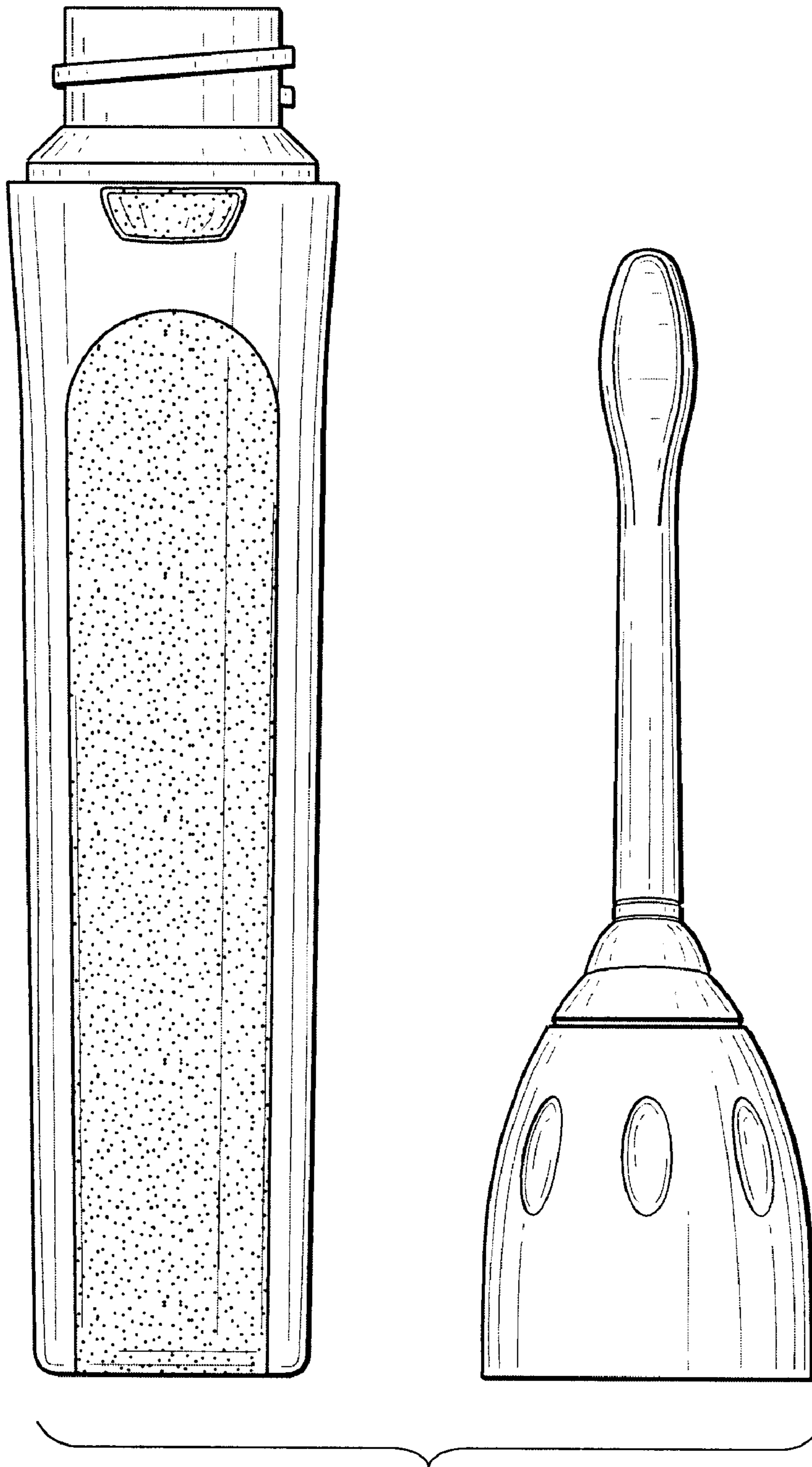

FIG. 9

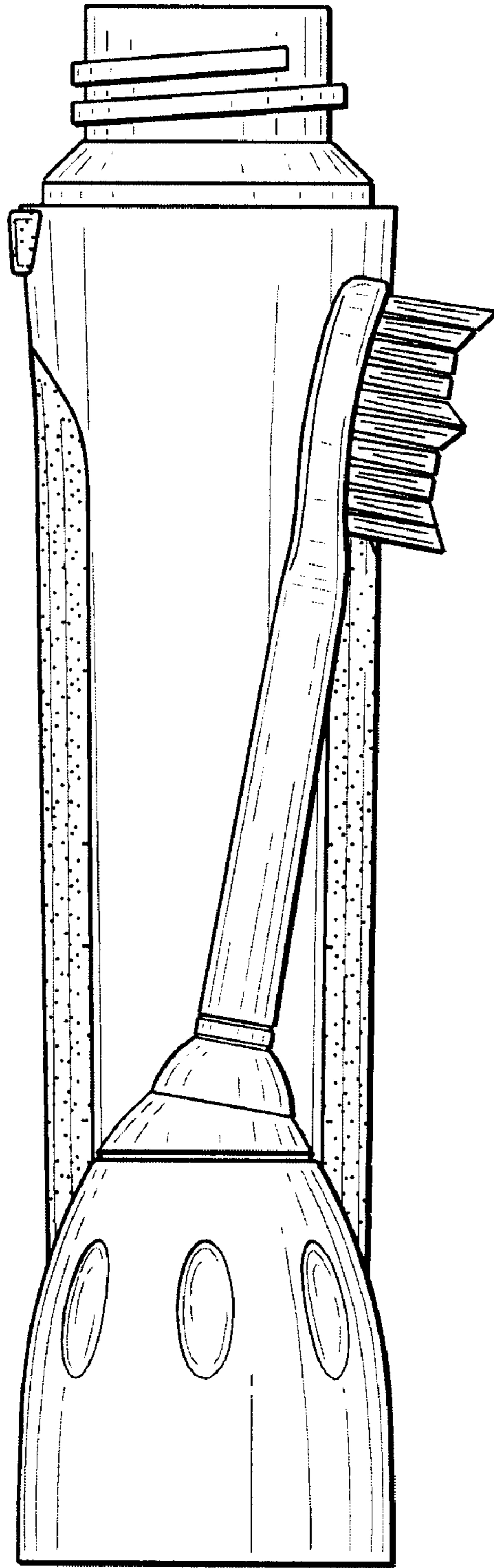

FIG. 10

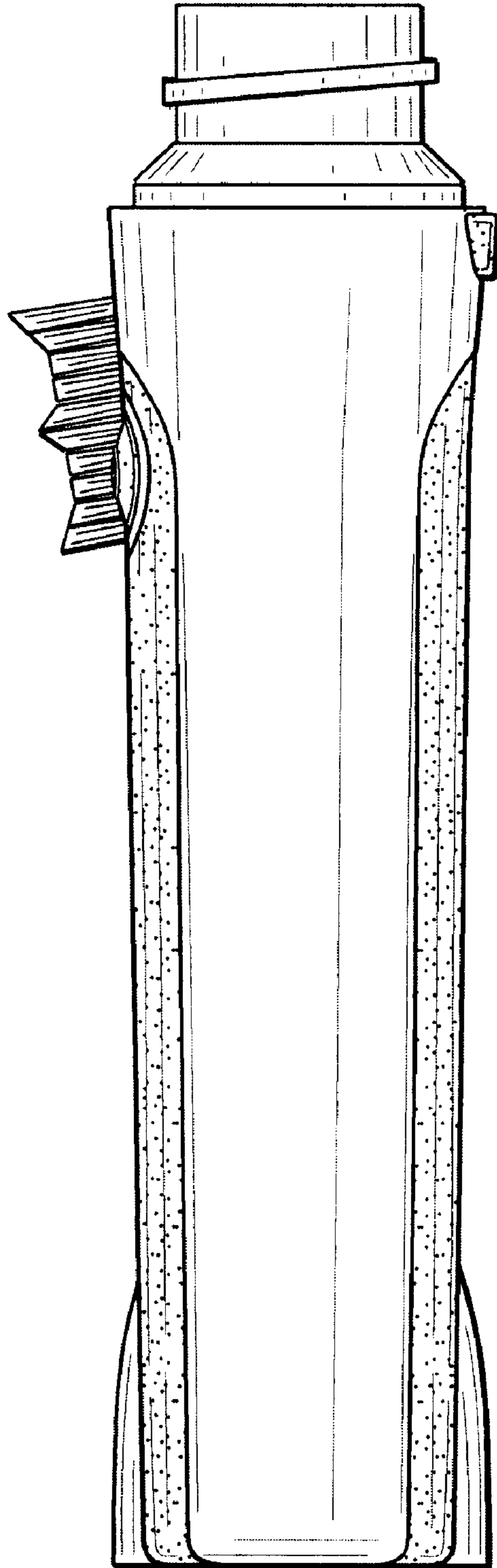

FIG. 11

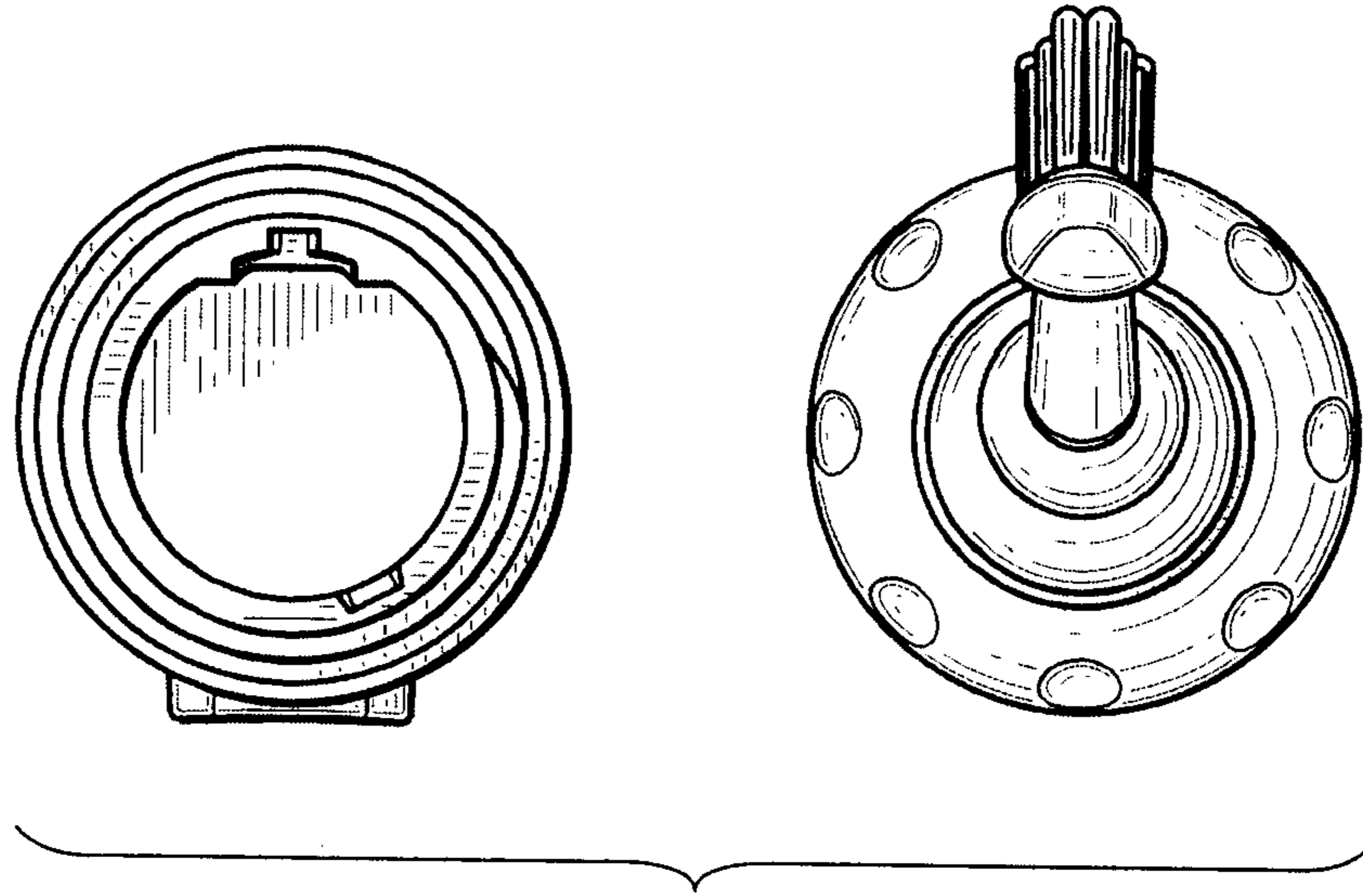

FIG. 12

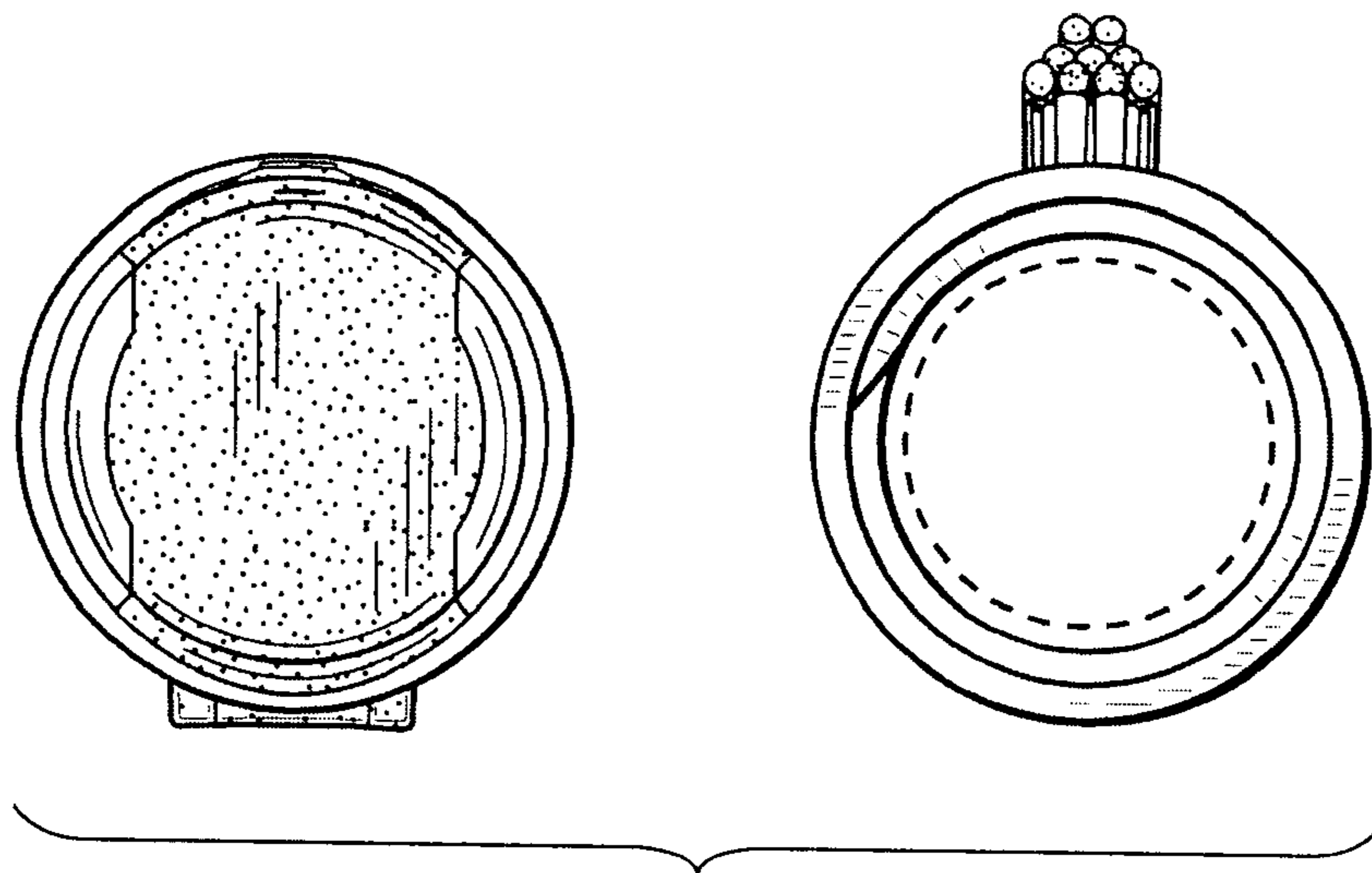

FIG. 13