



US00D478179S

(12) **United States Design Patent**
Fifield

(10) **Patent No.:** **US D478,179 S**

(45) **Date of Patent:** **** Aug. 5, 2003**

(54) **ROOF TILE**

D370,539 S * 6/1996 Treat D25/140

(75) Inventor: **John Fifield, Aylesbury (GB)**

* cited by examiner

(73) Assignee: **Westile, Inc., Casa Grande, AZ (US)**

Primary Examiner—Doris Clark

(**) Term: **14 Years**

(74) *Attorney, Agent, or Firm*—Killworth, Gottman, Hagan & Schaeff LLP

(21) Appl. No.: **29/156,700**

(57) **CLAIM**

(22) Filed: **Mar. 5, 2002**

The ornamental design for the roof tile, as shown.

(30) **Foreign Application Priority Data**

DESCRIPTION

Sep. 7, 2001 (GB) 2104643

(51) **LOC (7) Cl.** **25-01**

(52) **U.S. Cl.** **D25/140**

(58) **Field of Search** D25/139, 140;
52/519, 520

FIG. 1 is a perspective view of the bottom of the roof tile;
FIG. 2 is a perspective view of the top of the roof tile;
FIG. 3 is a left hand side view of the roof tile;
FIG. 4 is a top plan view of the roof tile;
FIG. 5 is a front end view of the roof tile;
FIG. 6 is a right hand side view of the roof tile;
FIG. 7 is a rear end view of the roof tile; and,
FIG. 8 is a bottom plan view of the roof tile.

(56) **References Cited**

U.S. PATENT DOCUMENTS

D256,277 S * 8/1980 Warden D25/140

1 Claim, 3 Drawing Sheets

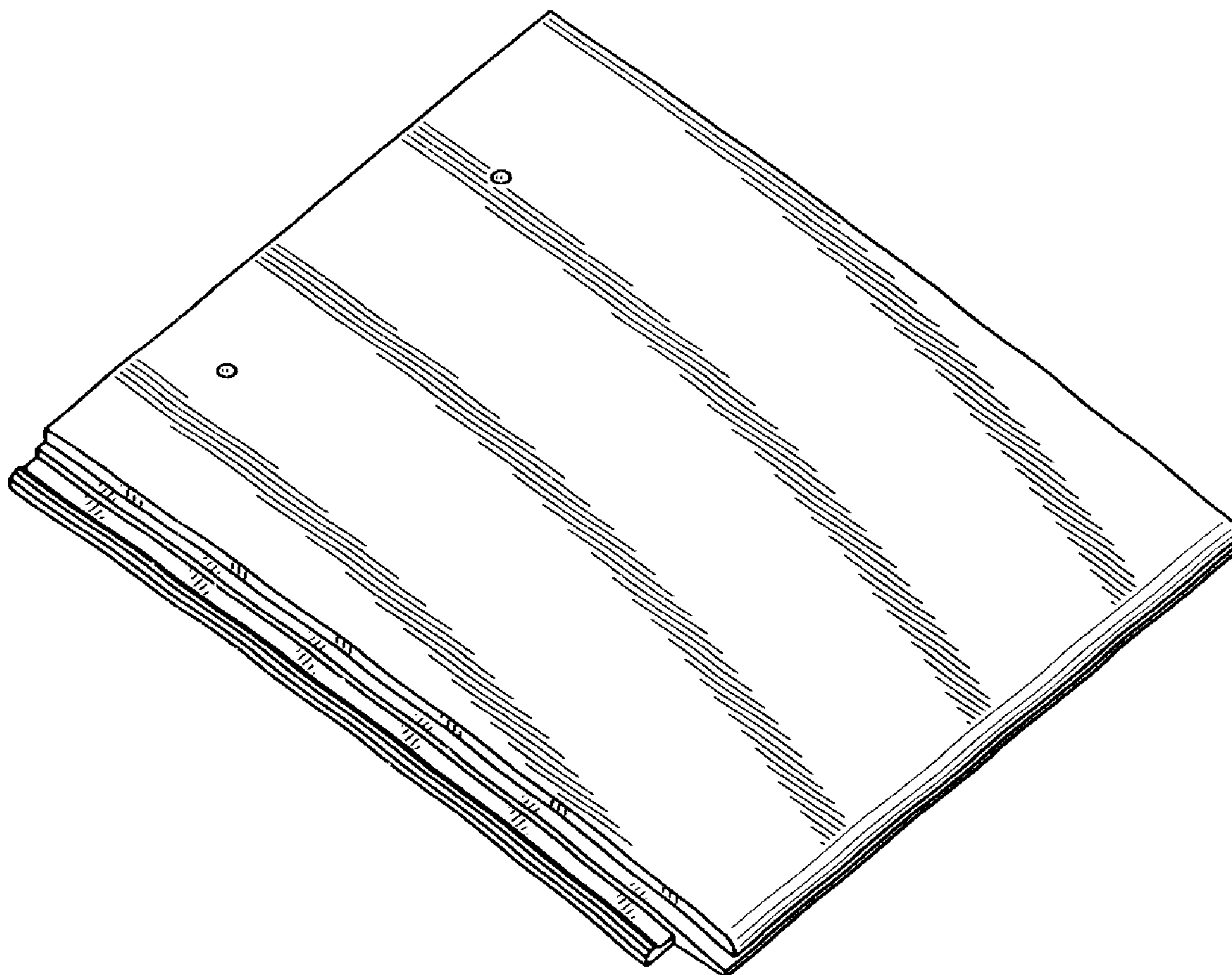

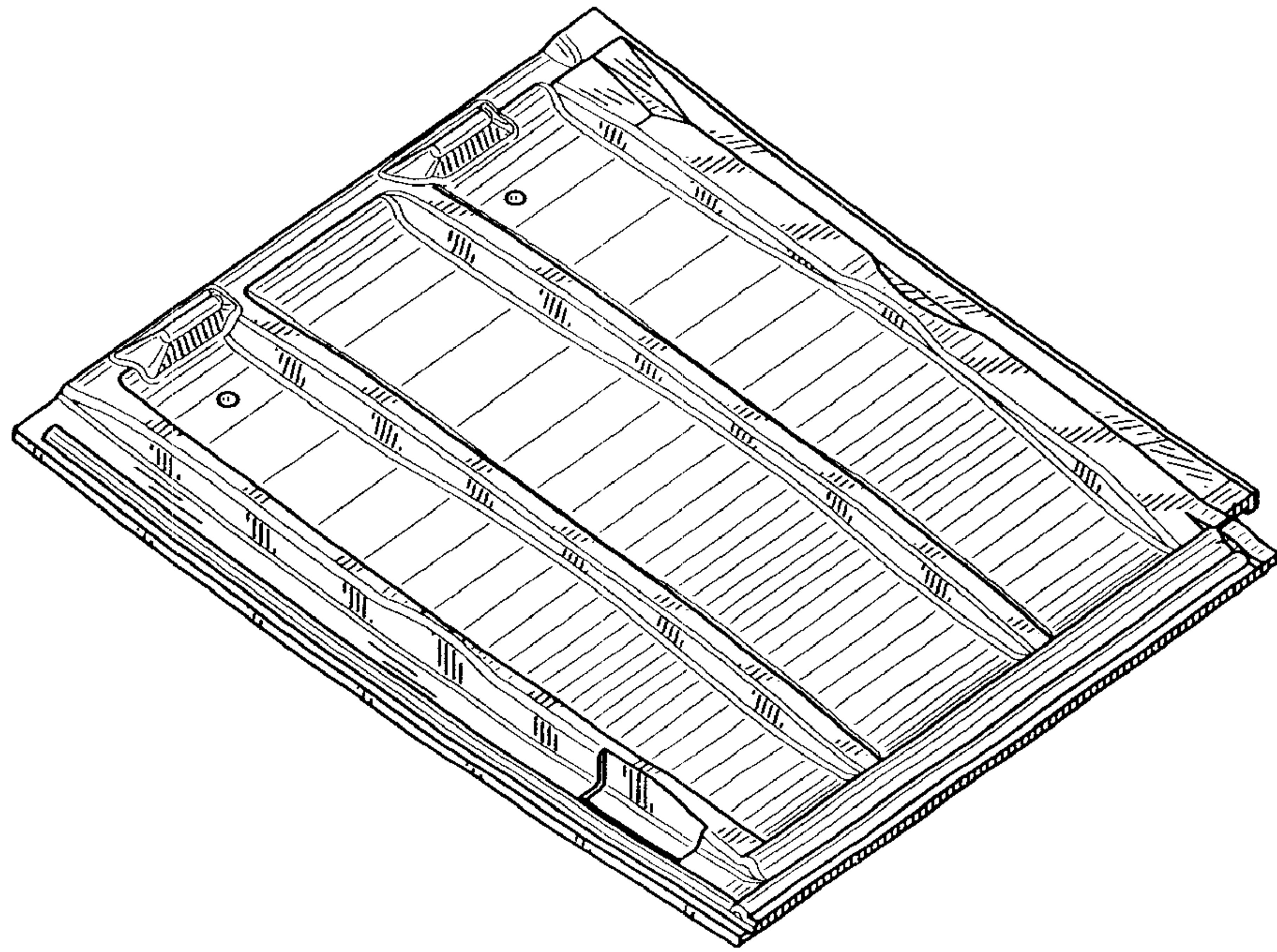

FIG. 1

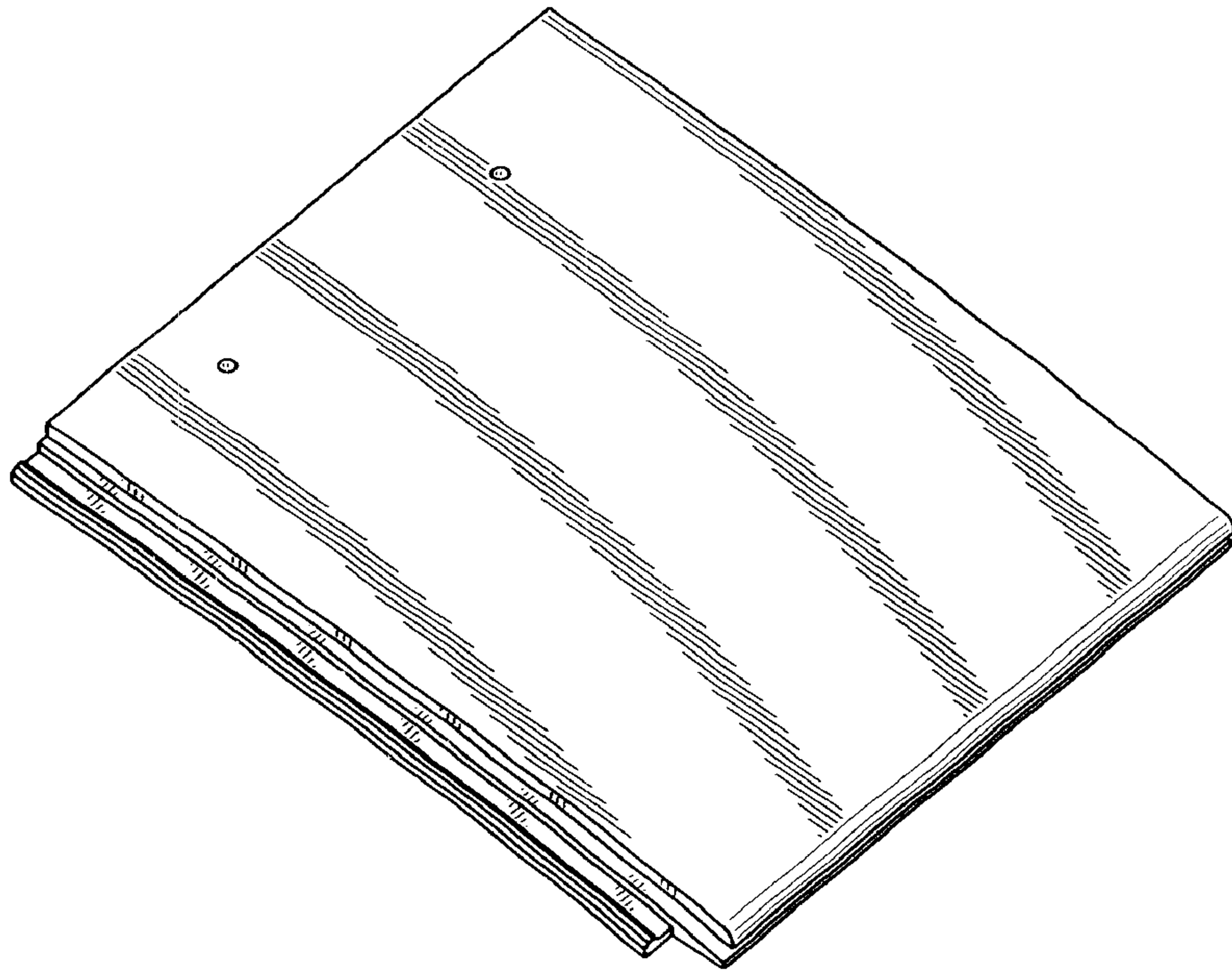

FIG. 2

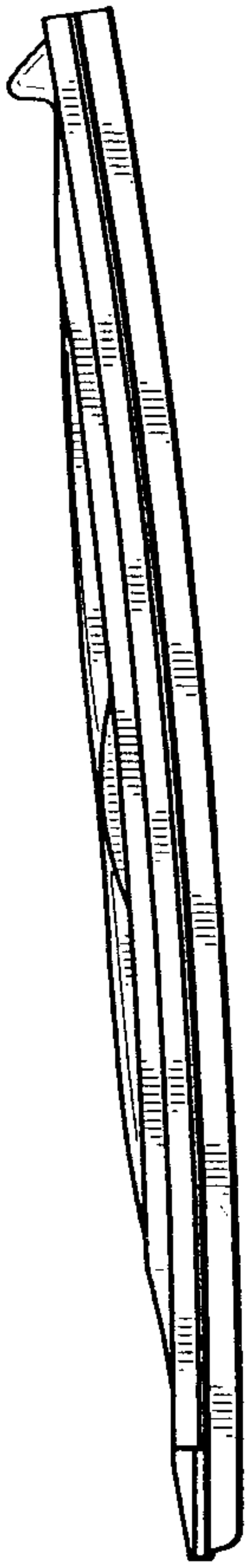

FIG. 3

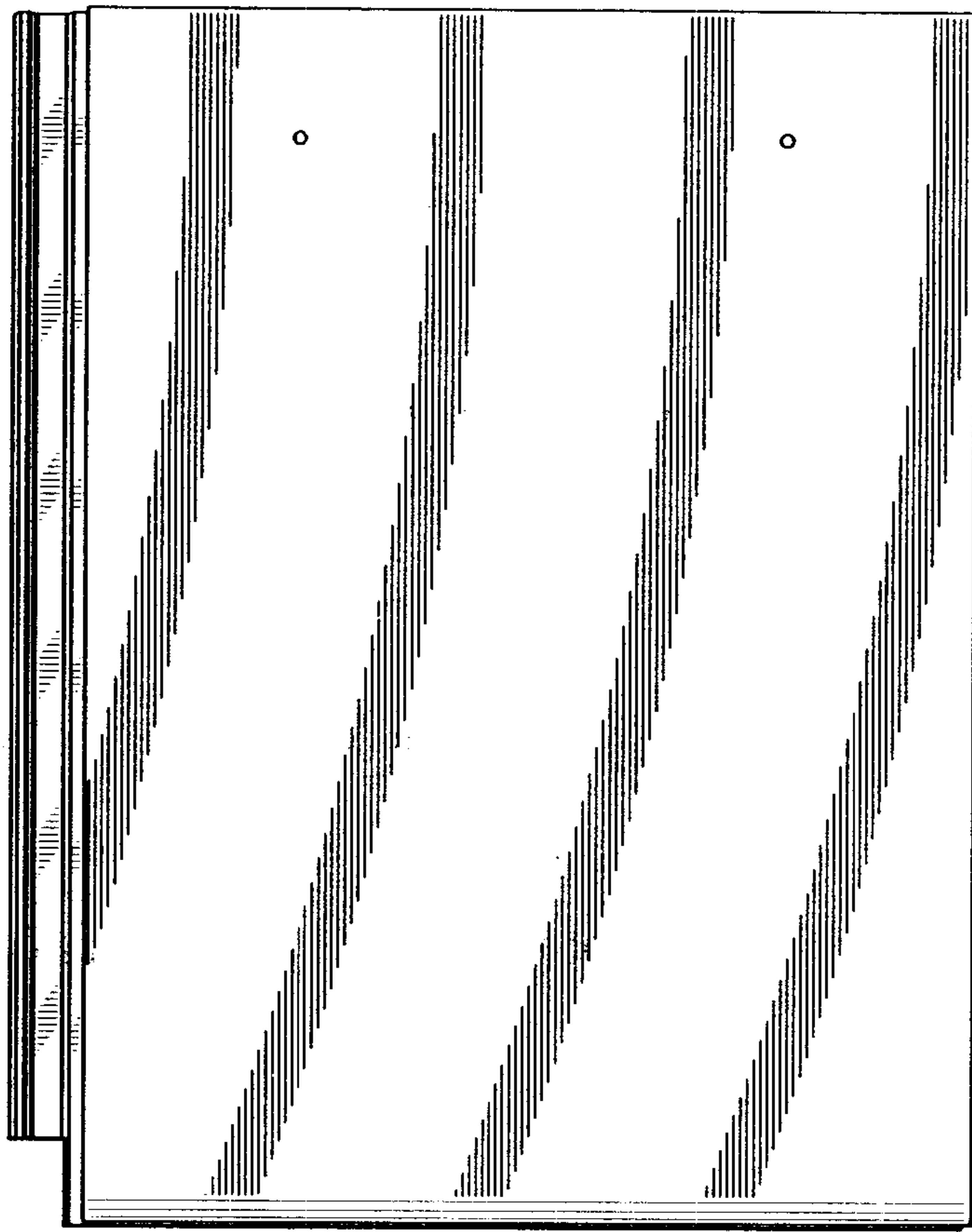

FIG. 4

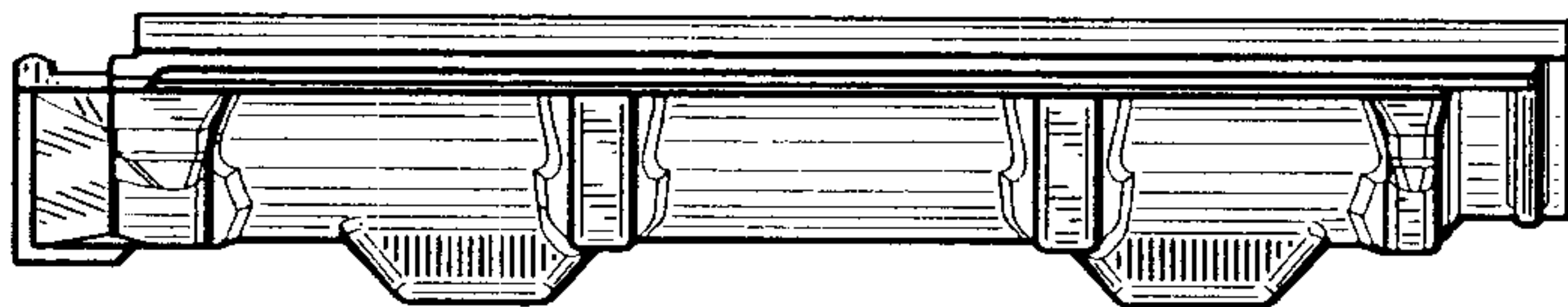

FIG. 5

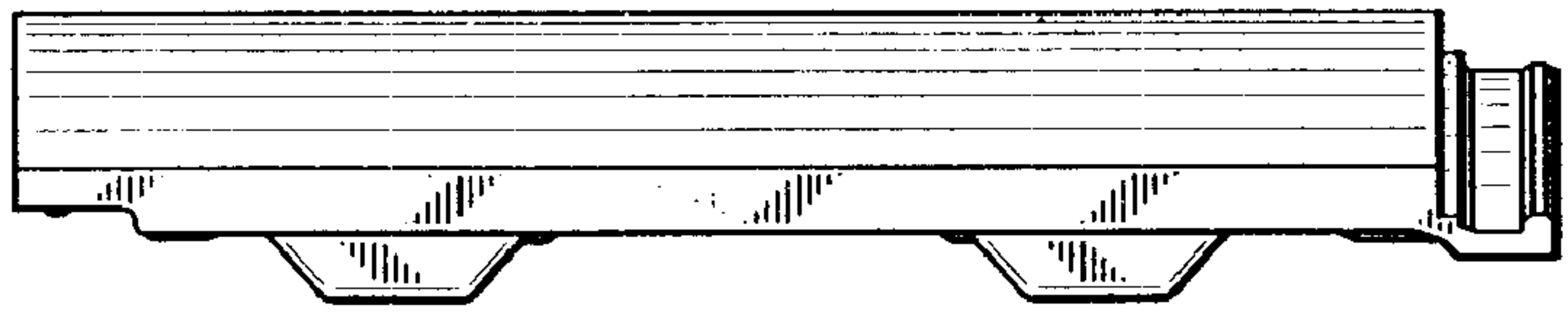

FIG. 7

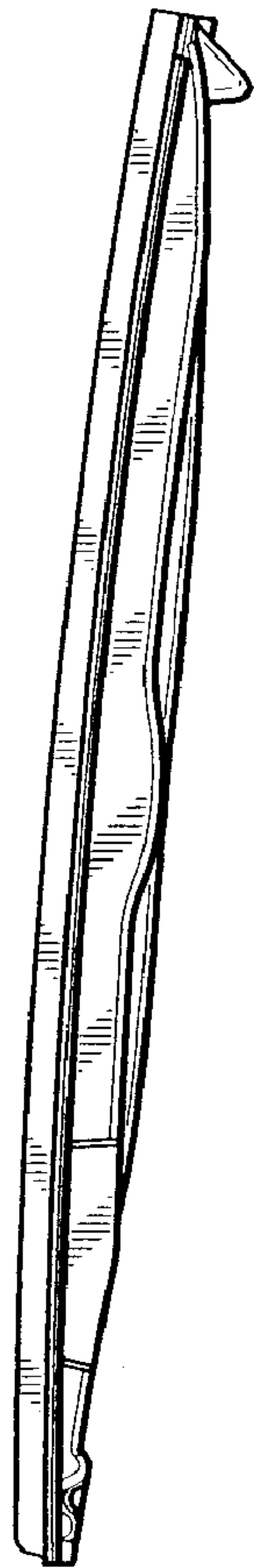

FIG. 6

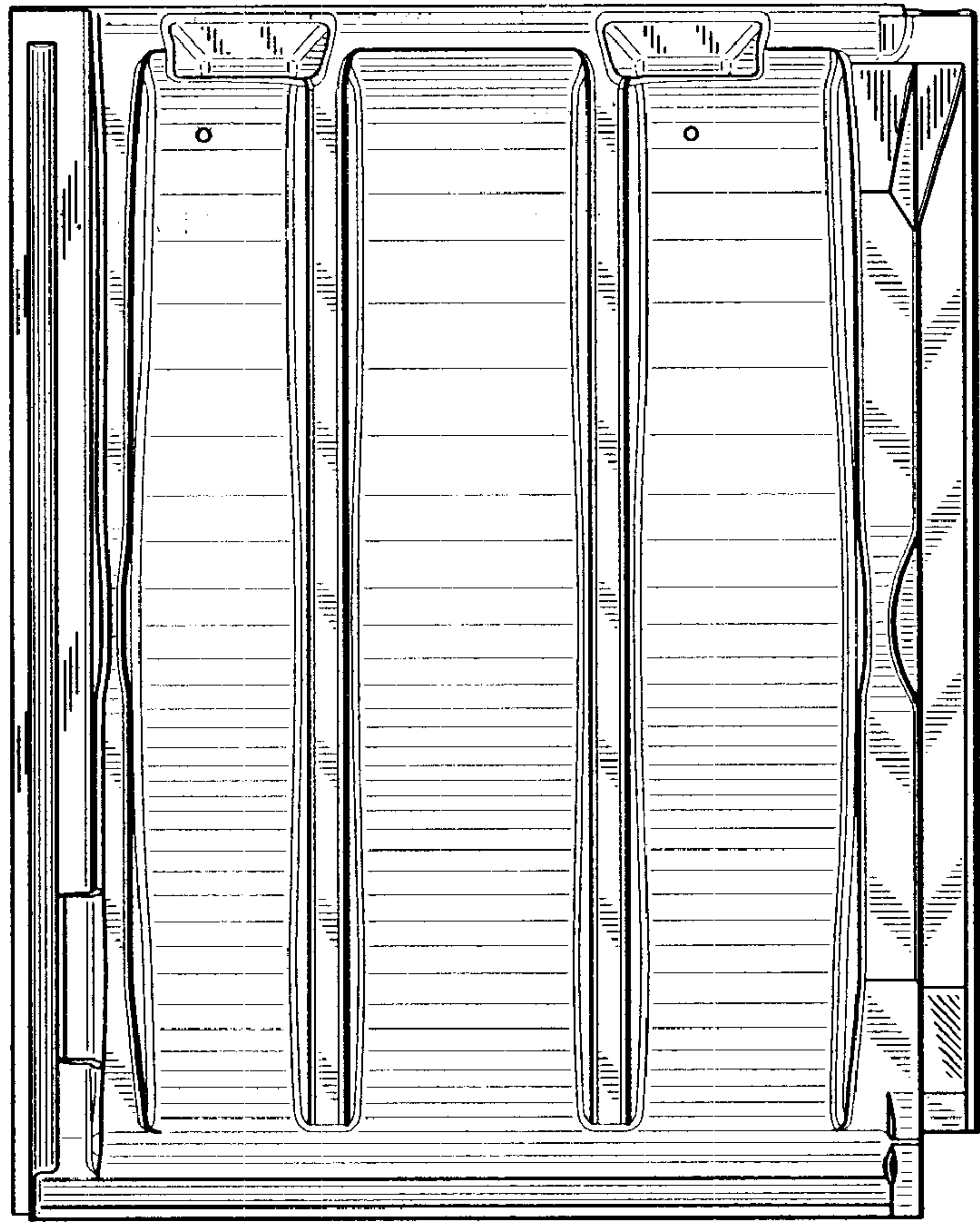

FIG. 8