



US00D478128S

(12) **United States Design Patent**
Hussaini et al.

(10) **Patent No.:** **US D478,128 S**

(45) **Date of Patent:** **** Aug. 5, 2003**

(54) **AUDIO AND VIDEO ACCESSORY FOR AN ELECTRONIC DEVICE**

Primary Examiner—Prabhakar Deshmukh
(74) *Attorney, Agent, or Firm*—Liniak, Berenato & White

(75) Inventors: **Saied Hussaini**, Miami, FL (US); **Marc Iacovelli**, Miami, FL (US)

(57) **CLAIM**

The ornamental design for an audio and video accessory for an electronic device, as shown and described.

(73) Assignee: **Intec, Inc.**, Miami, FL (US)

(**) Term: **14 Years**

DESCRIPTION

(21) Appl. No.: **29/161,969**

FIG. 1 is a front view of the audio and video accessory for an electronic device according to the present invention.

(22) Filed: **Jun. 10, 2002**

FIG. 2 is a rear view of the audio and video accessory for an electronic device of FIG. 1.

(51) **LOC (7) Cl.** **21-01**

FIG. 3 is a left side view of the audio and video accessory for an electronic device of FIG. 1.

(52) **U.S. Cl.** **D21/333; D14/496**

FIG. 4 is a right side view of the audio and video accessory for an electronic device of FIG. 1.

(58) **Field of Search** D21/324, 333;
D14/400, 401, 496, 432, 315; 273/148 B;
463/1, 30-35, 43-47; 345/156, 905, 728

FIG. 5 is a top view of the audio and video accessory for an electronic device of FIG. 1.

(56) **References Cited**

FIG. 6 is a bottom view of the audio and video accessory for an electronic device of FIG. 1.

U.S. PATENT DOCUMENTS

FIG. 7 is a rear view of the audio and video accessory for an electronic device of FIG. 1 in an alternate position; and,

D335,123 S *	4/1993	Smiley	D14/315
D366,251 S *	1/1996	Rak et al.	D14/315
6,254,477 B1 *	7/2001	Sasaki et al.	463/47
6,307,535 B1 *	10/2001	Kim et al.	345/156
6,400,351 B1 *	6/2002	Ishizawa et al.	345/156
D462,723 S *	9/2002	Ashida	D21/333
6,507,338 B1 *	1/2003	Liao et al.	345/156

FIG. 8 is a front and left perspective view of the audio and video accessory for an electronic device according to the present invention.

The broken lines are for illustration purposes only and form no part of the claimed design.

* cited by examiner

1 Claim, 6 Drawing Sheets

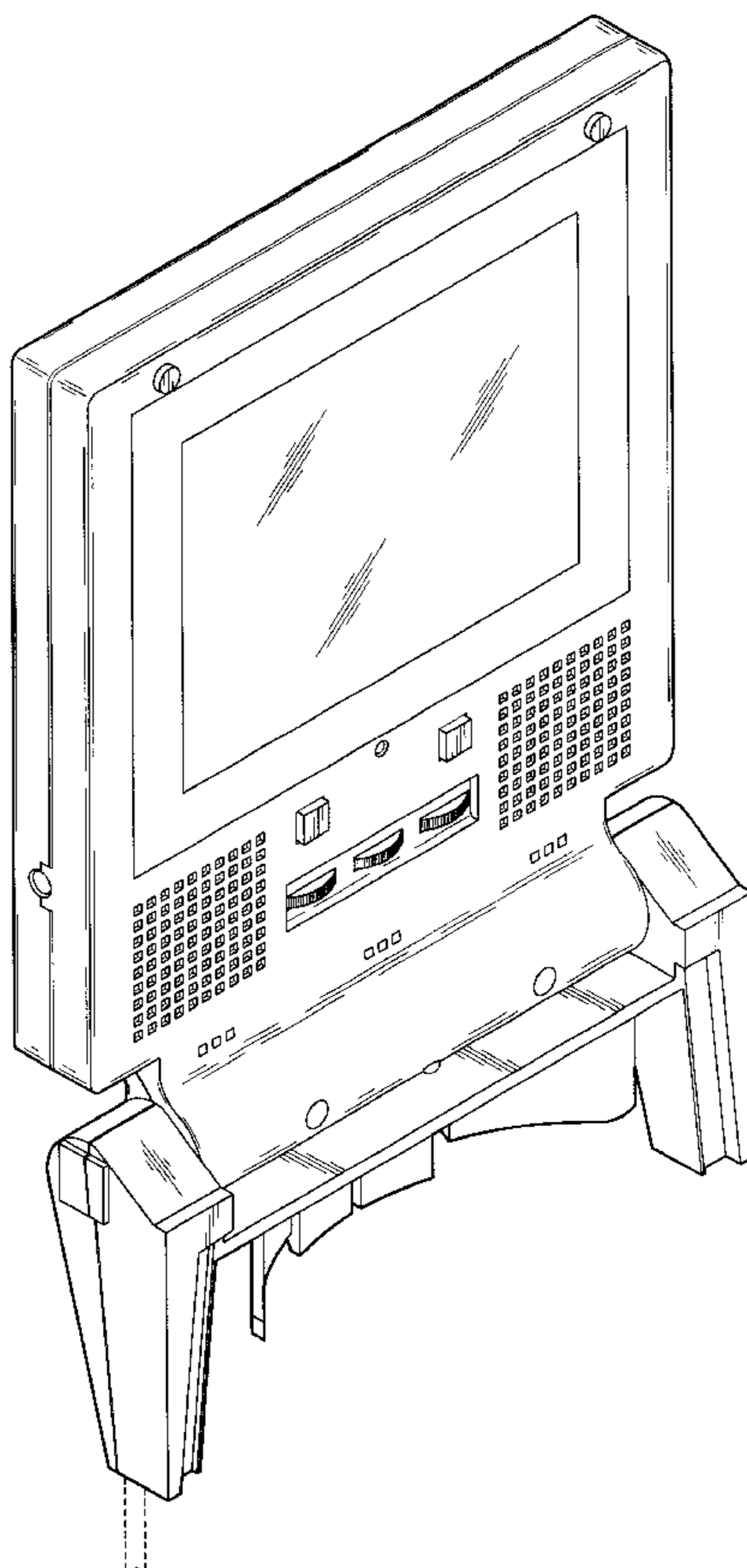

Fig. 1

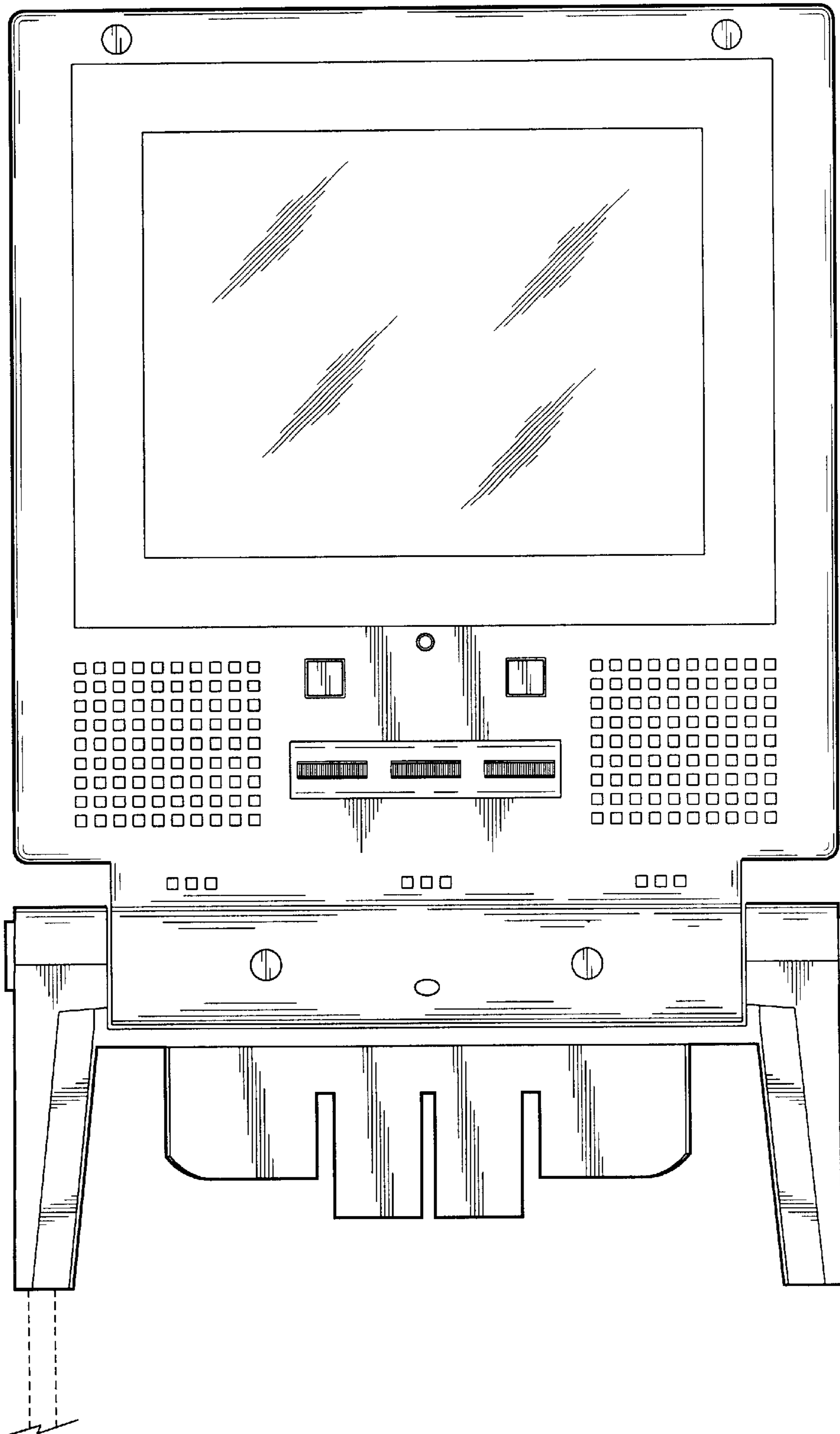

Fig. 2

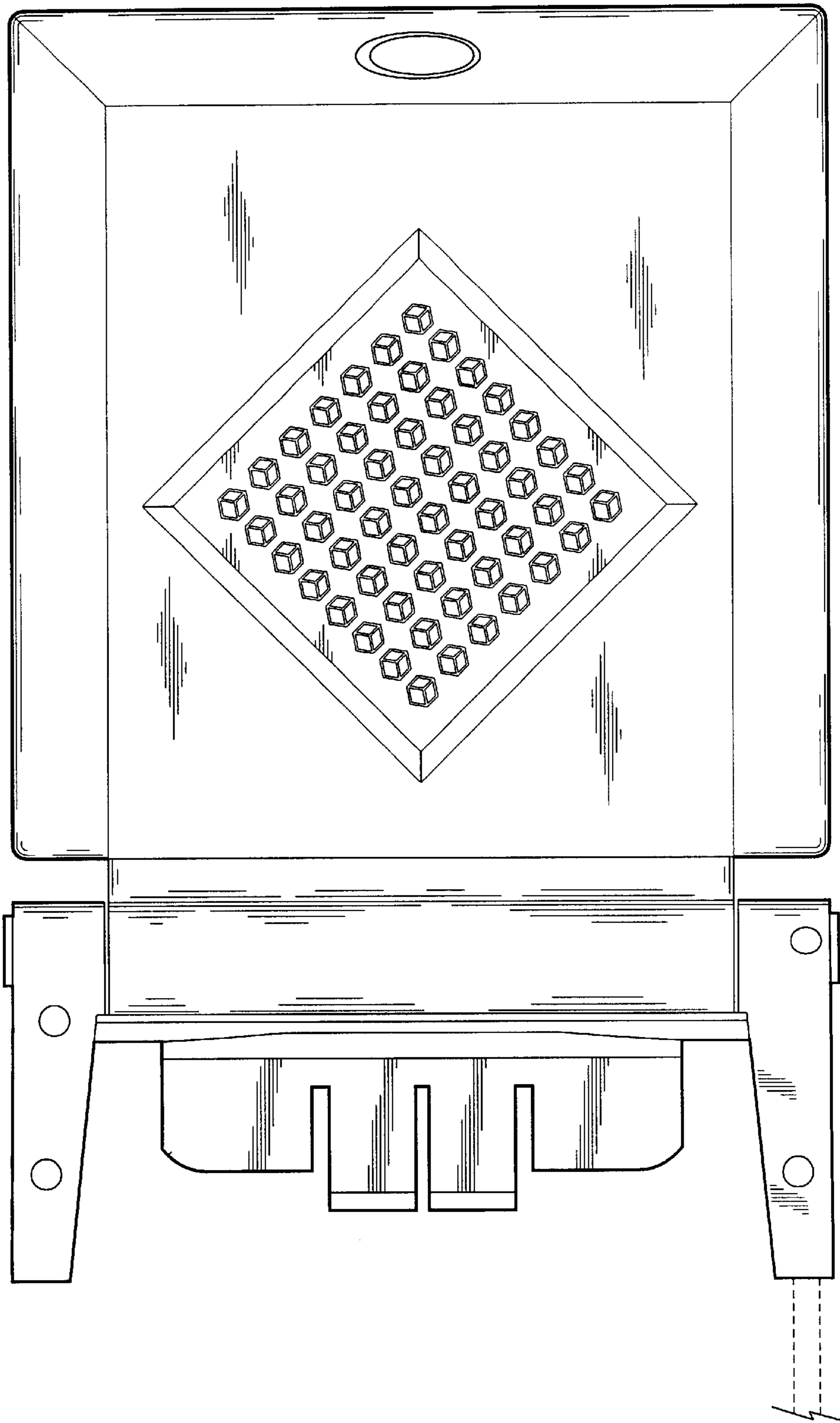

Fig. 3

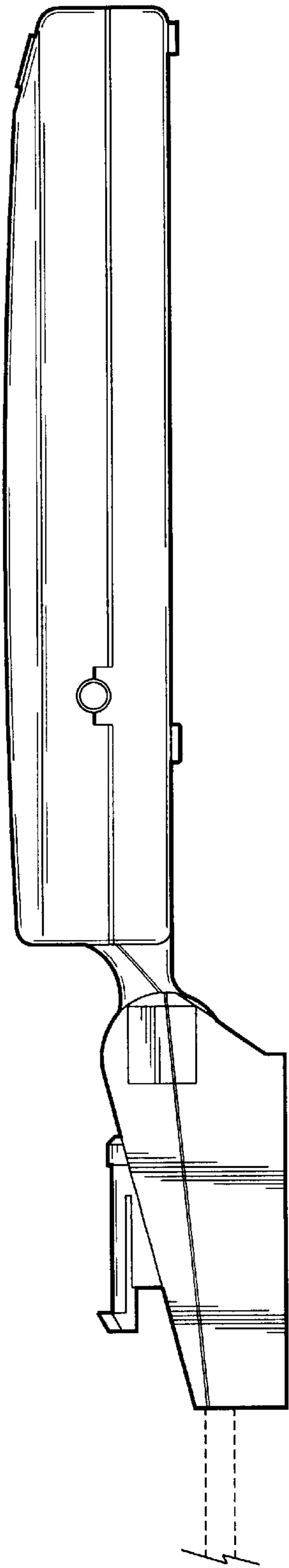

Fig. 4

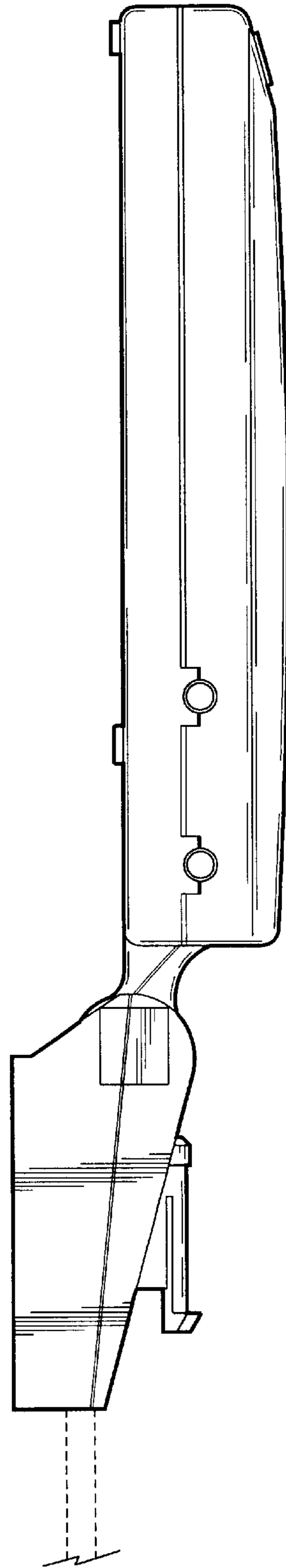

Fig. 5

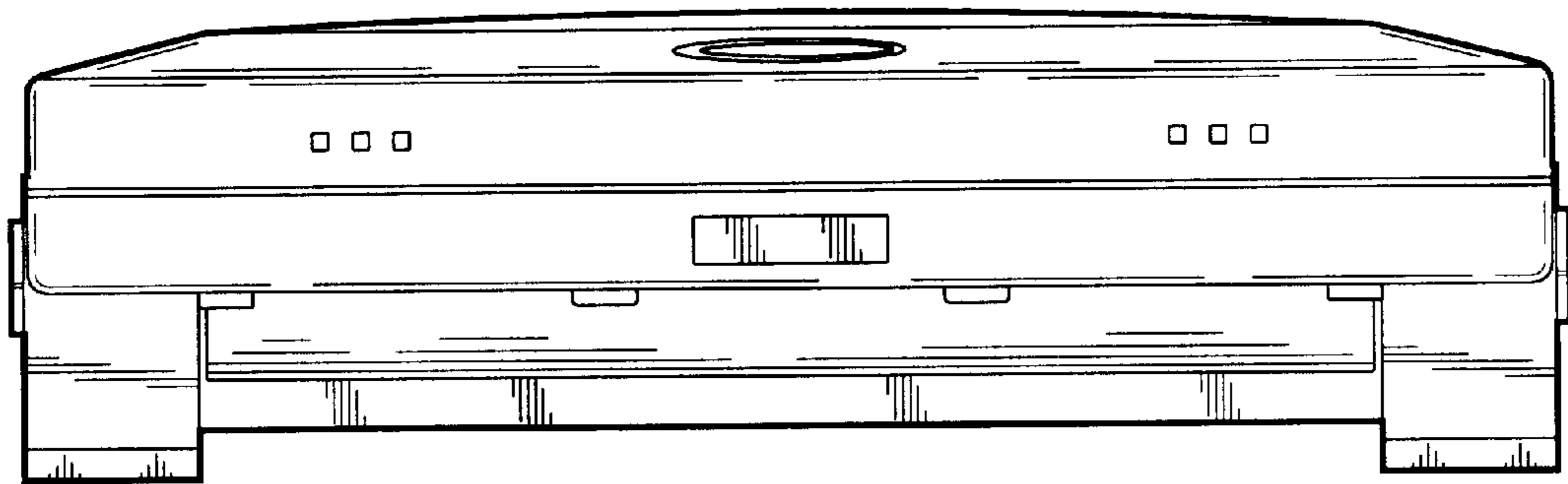

Fig. 6

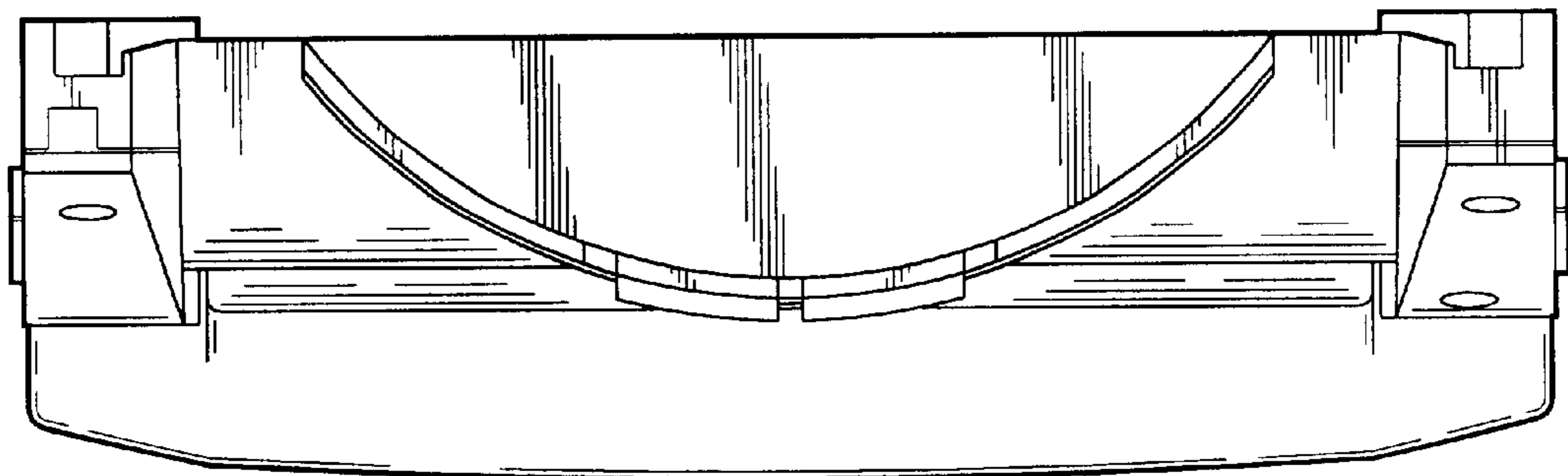

Fig. 7

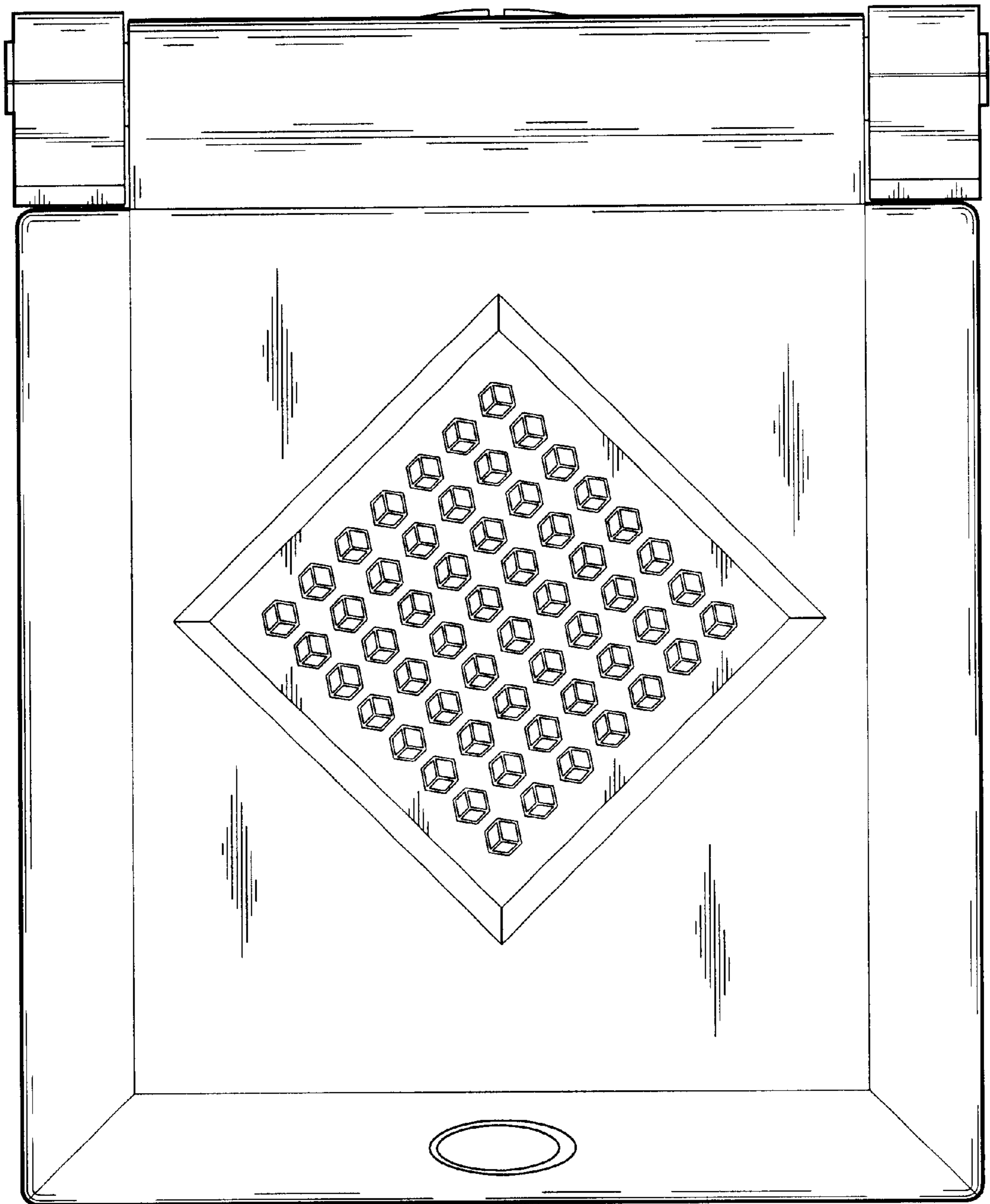

Fig. 8

