



US00D478084S

(12) **United States Design Patent**
Khovaylo et al.

(10) **Patent No.:** **US D478,084 S**
(45) **Date of Patent:** **** Aug. 5, 2003**

(54) **OPTICAL SCANNER**

(List continued on next page.)

(75) Inventors: **Modest Khovaylo**, Fort Collins, CO (US); **Scott Henderson**, Brooklyn, NY (US); **Przemyslaw Godycki**, New York, NY (US); **Nao Tamura**, New York, NY (US)

Primary Examiner—Freda Nunn

(73) Assignee: **Hewlett-Packard Development Company**, Houston, TX (US)

(57) **CLAIM**

The ornamental design for an optical scanner, as shown and described.

(**) Term: **14 Years**

DESCRIPTION

(21) Appl. No.: **29/164,138**

(22) Filed: **Jul. 18, 2002**

(51) **LOC (7) Cl.** **14-02**

(52) **U.S. Cl.** **D14/425**

(58) **Field of Search** D14/421, 422, D14/424, 425; D18/36, 37, 39; 250/556; 235/476, 482, 483, 470; 355/64, 65, 75, 81

FIG. 1 is a top front isometric view of an optical scanner; FIG. 2 is a top rear isometric view thereof; FIG. 3 is a top plan view thereof; FIG. 4 is a bottom plan view thereof; FIG. 5 is a front elevation view thereof; FIG. 6 is a rear elevation view thereof; FIG. 7 is a left side elevation view thereof; FIG. 8 is a right side elevation view thereof; FIG. 9 is a top front isometric view of a second embodiment of an optical scanner; FIG. 10 is a top rear isometric view of the second embodiment; FIG. 11 is a top plan isometric view of the second embodiment; FIG. 12 is a bottom plan view of the second embodiment; FIG. 13 is a front elevation view of the second embodiment; FIG. 14 is a rear elevation view of the second embodiment; FIG. 15 is a left side elevation view of the second embodiment; and, FIG. 16 is a right side elevation view of the second embodiment.

(56) **References Cited**

U.S. PATENT DOCUMENTS

D336,078 S	6/1993	Khovaylo	
D412,496 S	8/1999	Khovaylo et al.	
D419,140 S	* 1/2000	Khovaylo et al. D14/425
D421,746 S	3/2000	Khovaylo et al.	
D443,277 S	* 6/2001	Khovaylo et al. D14/425
D444,150 S	* 6/2001	Khovaylo et al. D14/425
D447,142 S	8/2001	Khovaylo et al.	
D448,383 S	* 9/2001	Khovaylo et al. D14/425
D449,063 S	10/2001	Khovaylo et al.	
D450,668 S	11/2001	Khovaylo et al.	
D456,412 S	4/2002	Khovaylo et al.	

OTHER PUBLICATIONS

U.S. Design patent application Ser. No. 29/164,136, filed Jul. 18, 2002 for "Optical Scanner" of Modest Khovaylo, et al.

U.S. Design patent application Ser. No. 29/164,122, filed Jul. 18, 2002 for "Optical Scanner" of Modest Khovaylo, et al.

In FIGS. 9–16 the areas including dot stipple shading, the areas including polka dot stipple shading, the areas including triangle stripple shading and the areas with no stipple shading each represent areas of different contrasting colors. Features shown in dashed lines in the drawing figures form no part of the claimed design of the embodiment shown in the subject drawing figures.

1 Claim, 12 Drawing Sheets

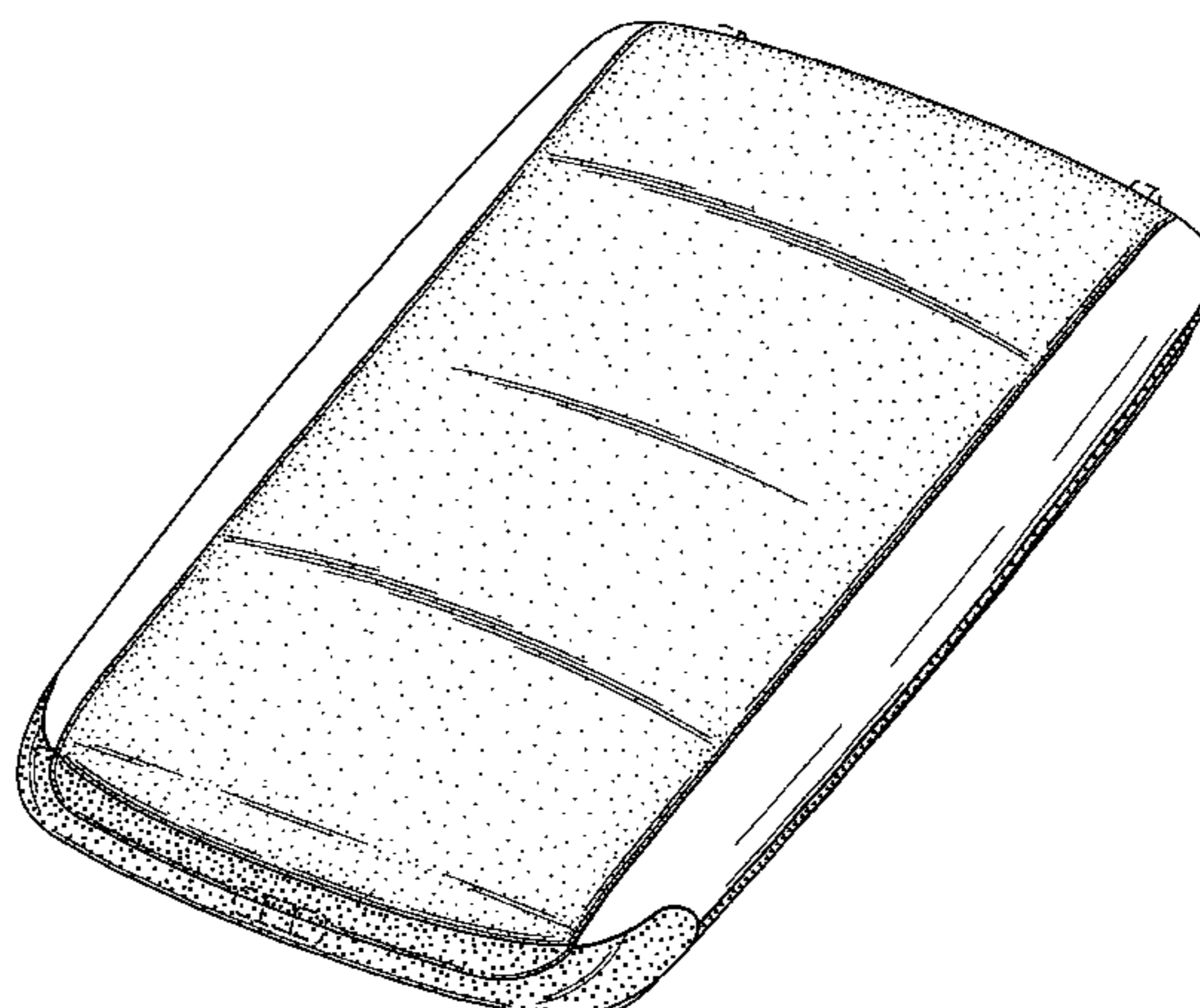
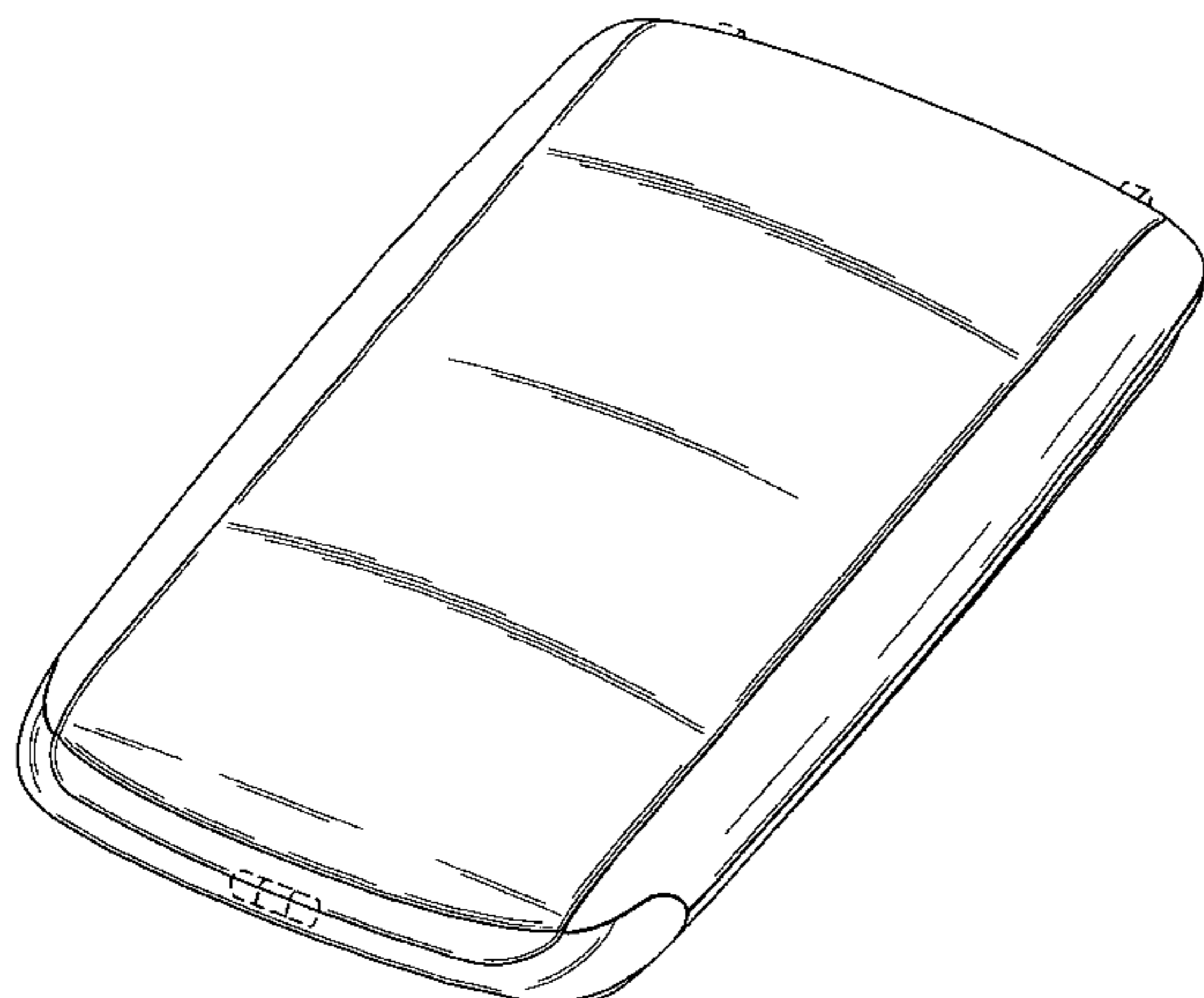

OTHER PUBLICATIONS

U.S. Design patent application Ser. No. 29/164,123, filed Jul. 18, 2002 for "Optical Scanner Assembly" of Modest Khovaylo, et al.

U.S. Design patent application Ser. No. 29/164,135, filed Jul. 18, 2002 for "Optical Scanner Assembly" of Modest Khovaylo, et al.

U.S. Design patent application Ser. No. 29/164,137, filed Jul. 18, 2002 for "Optical Scanner" of Modest Khovaylo, et al.

* cited by examiner

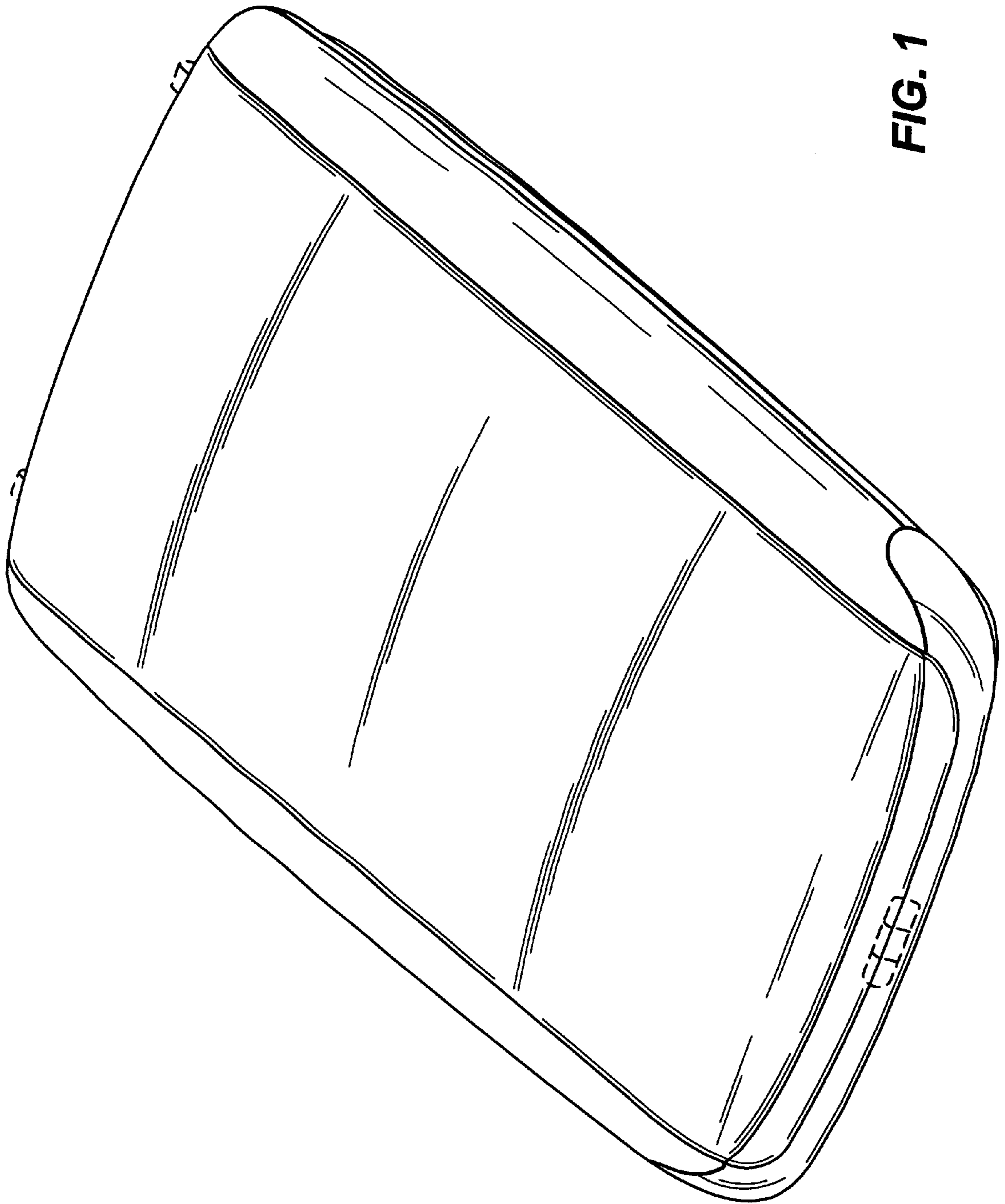

FIG. 1

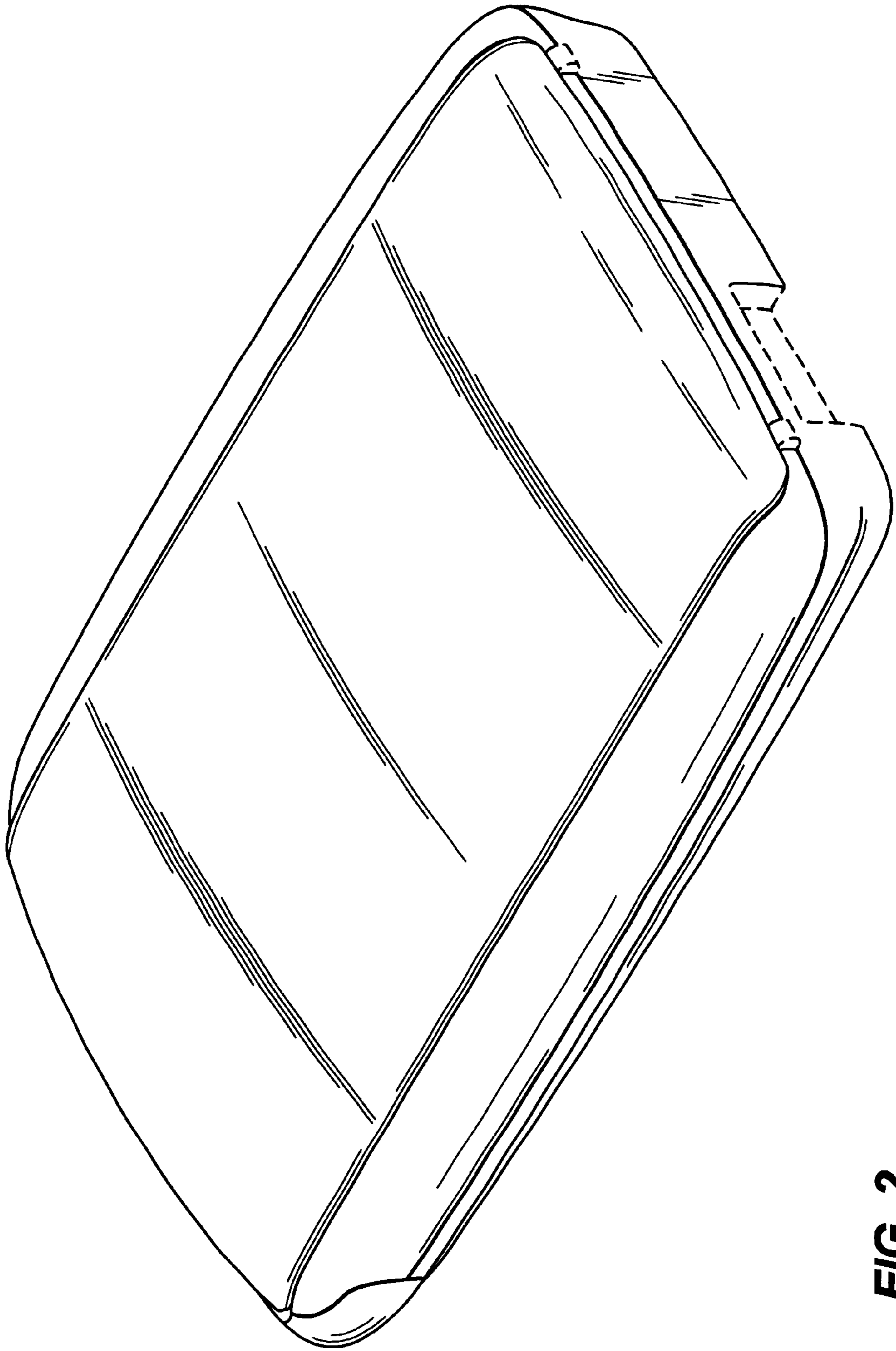

FIG. 2

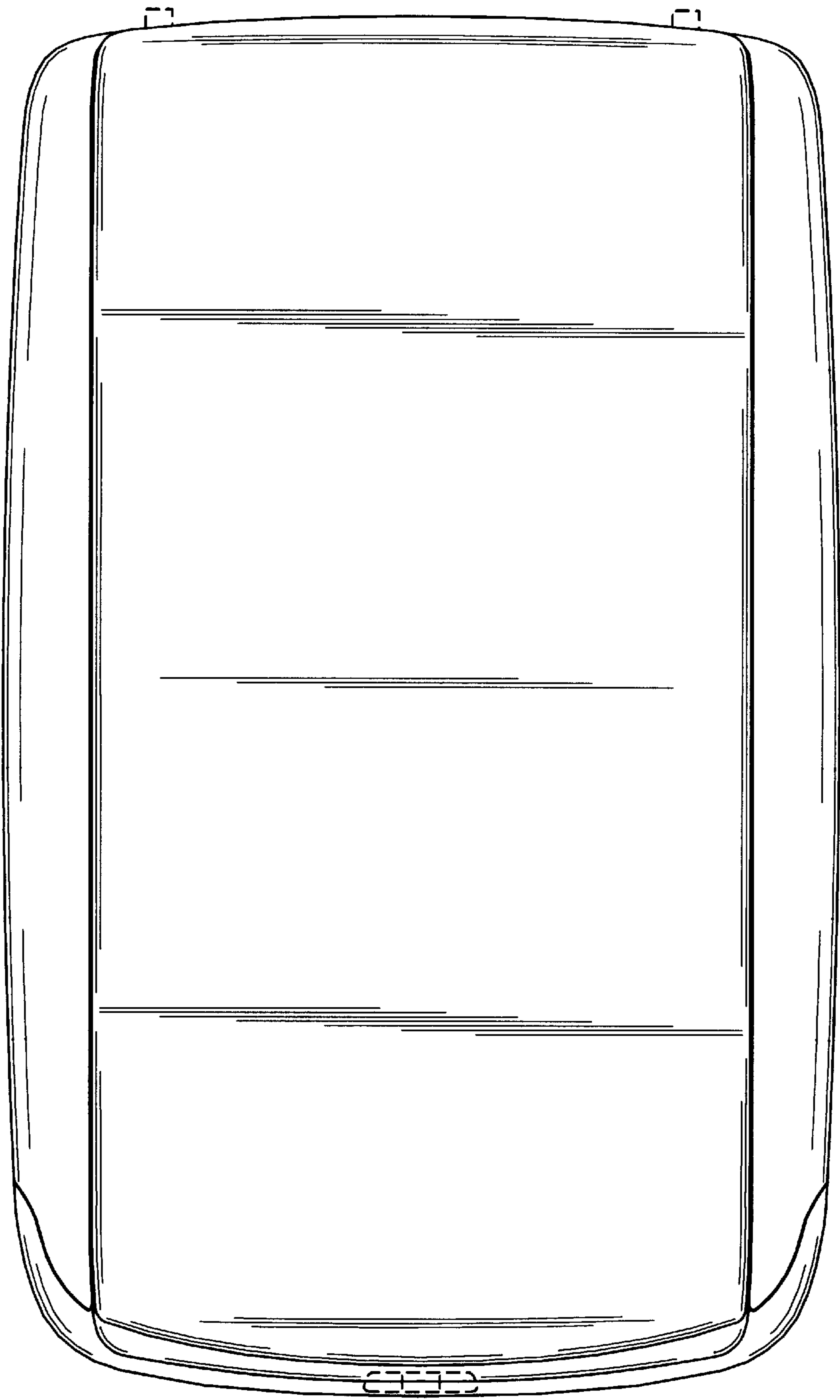

FIG. 3

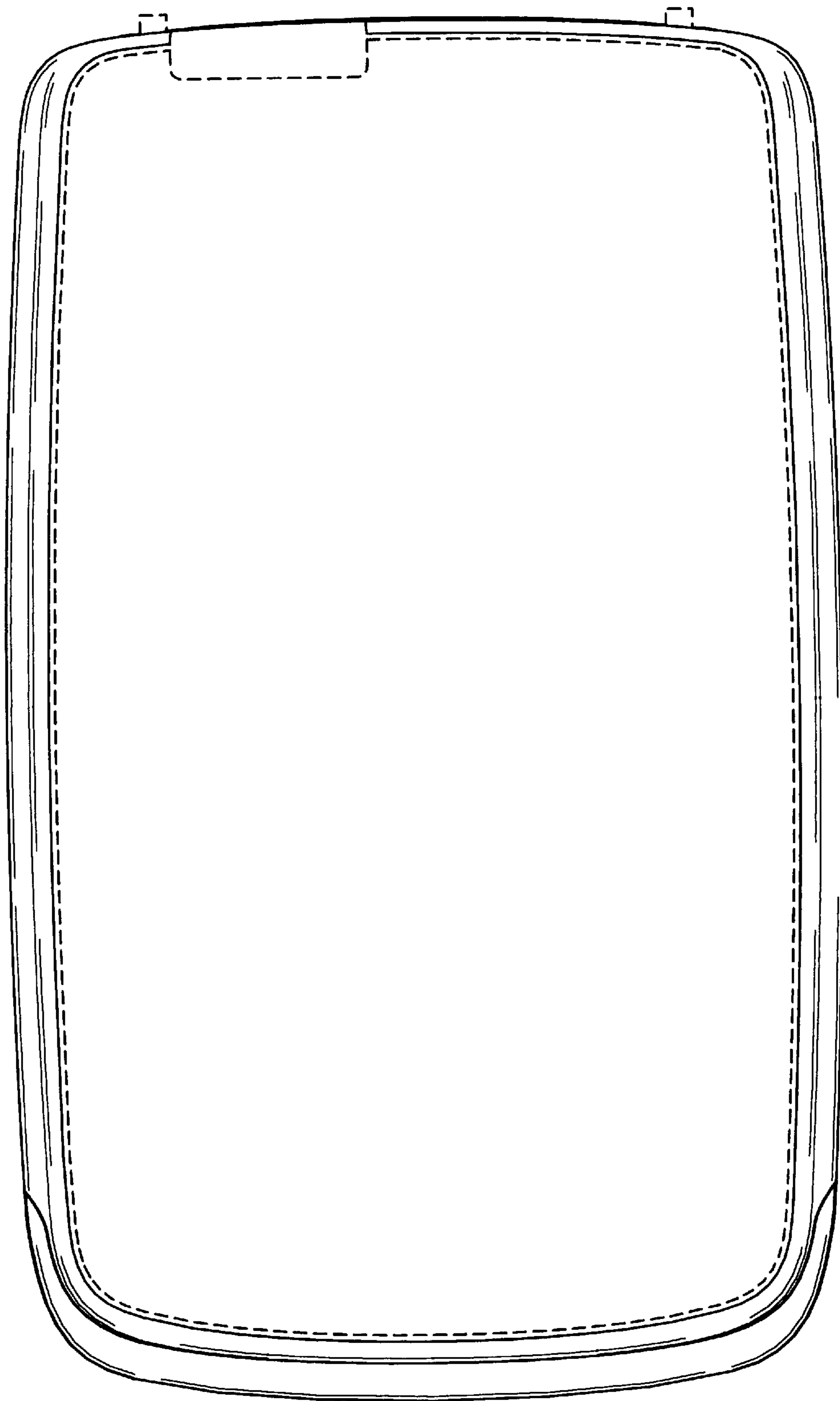

FIG. 4

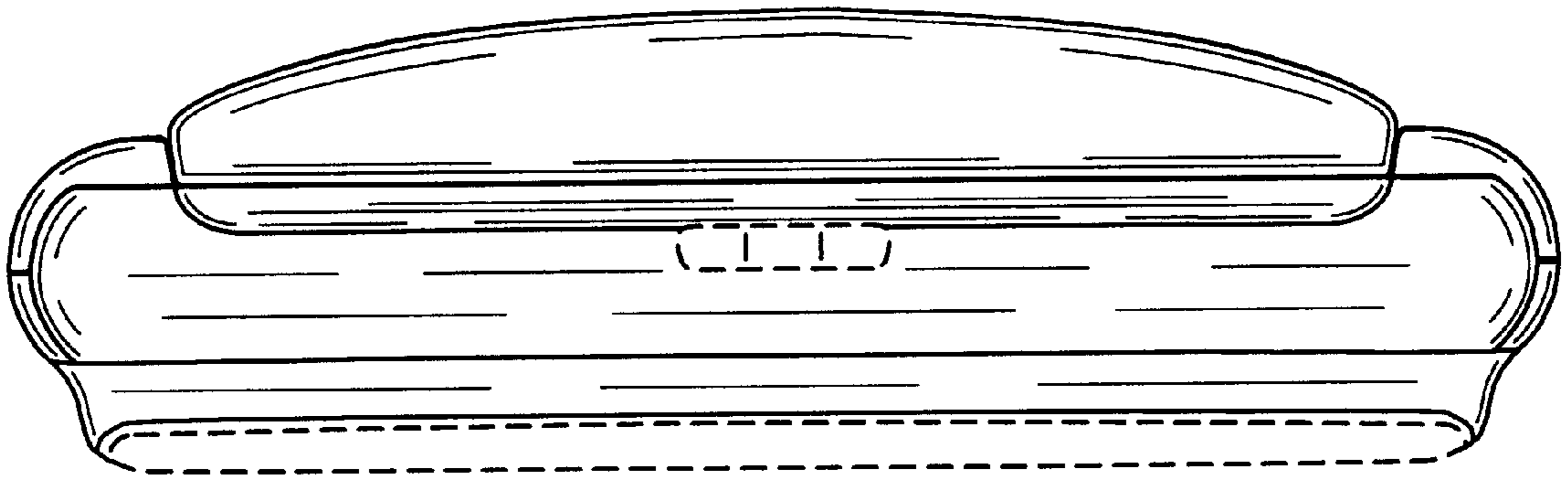

FIG. 5

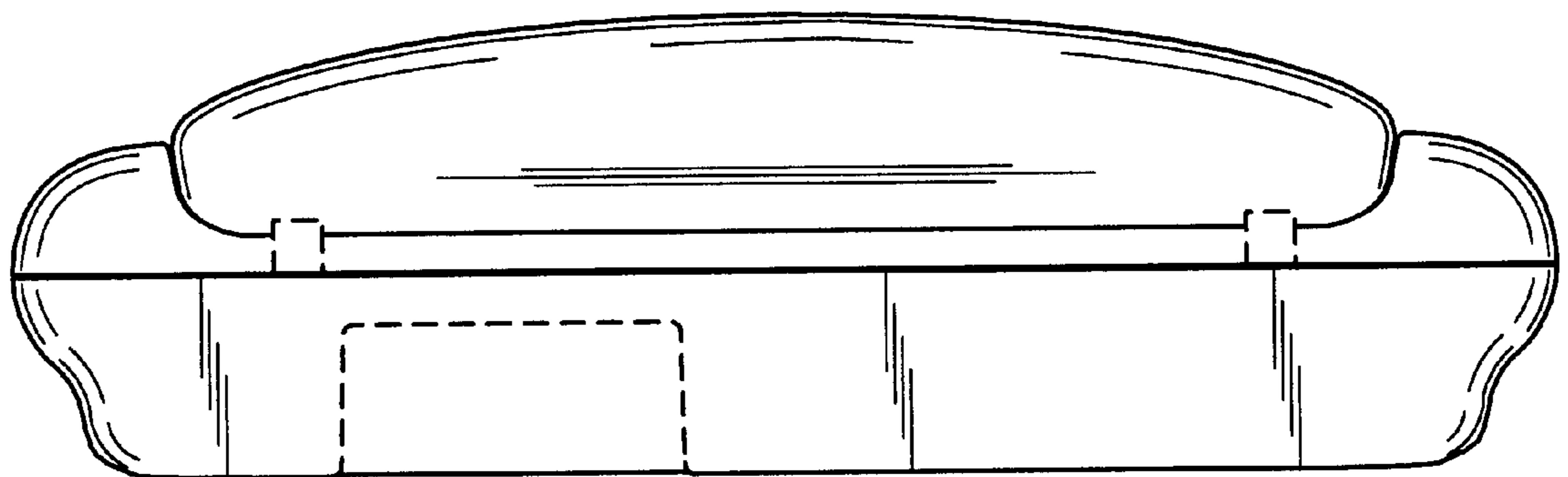

FIG. 6

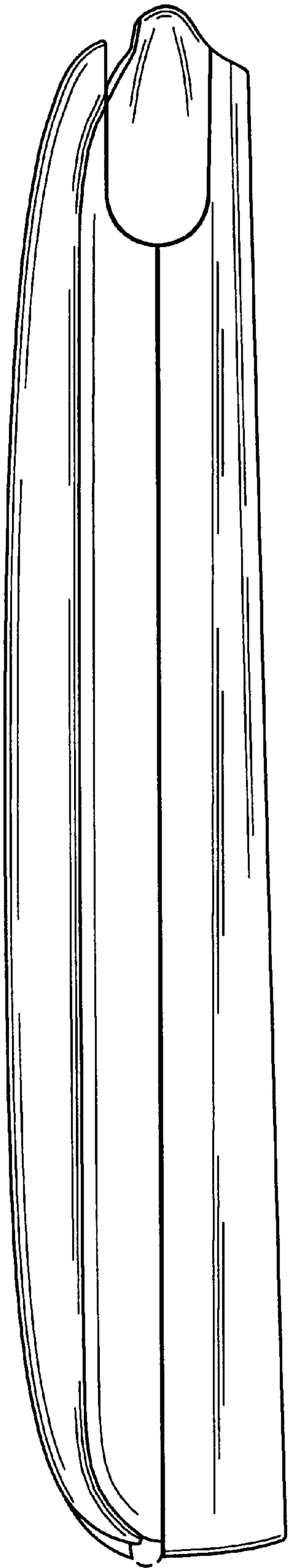

FIG. 7

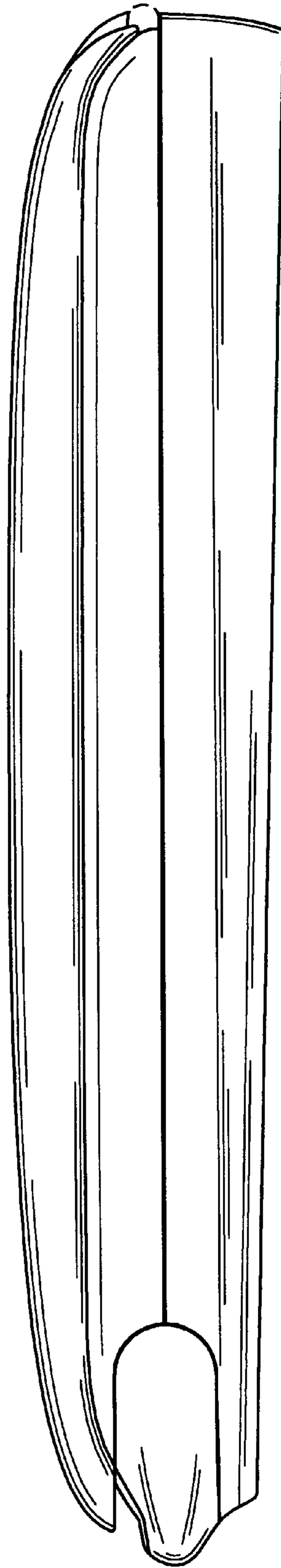

FIG. 8

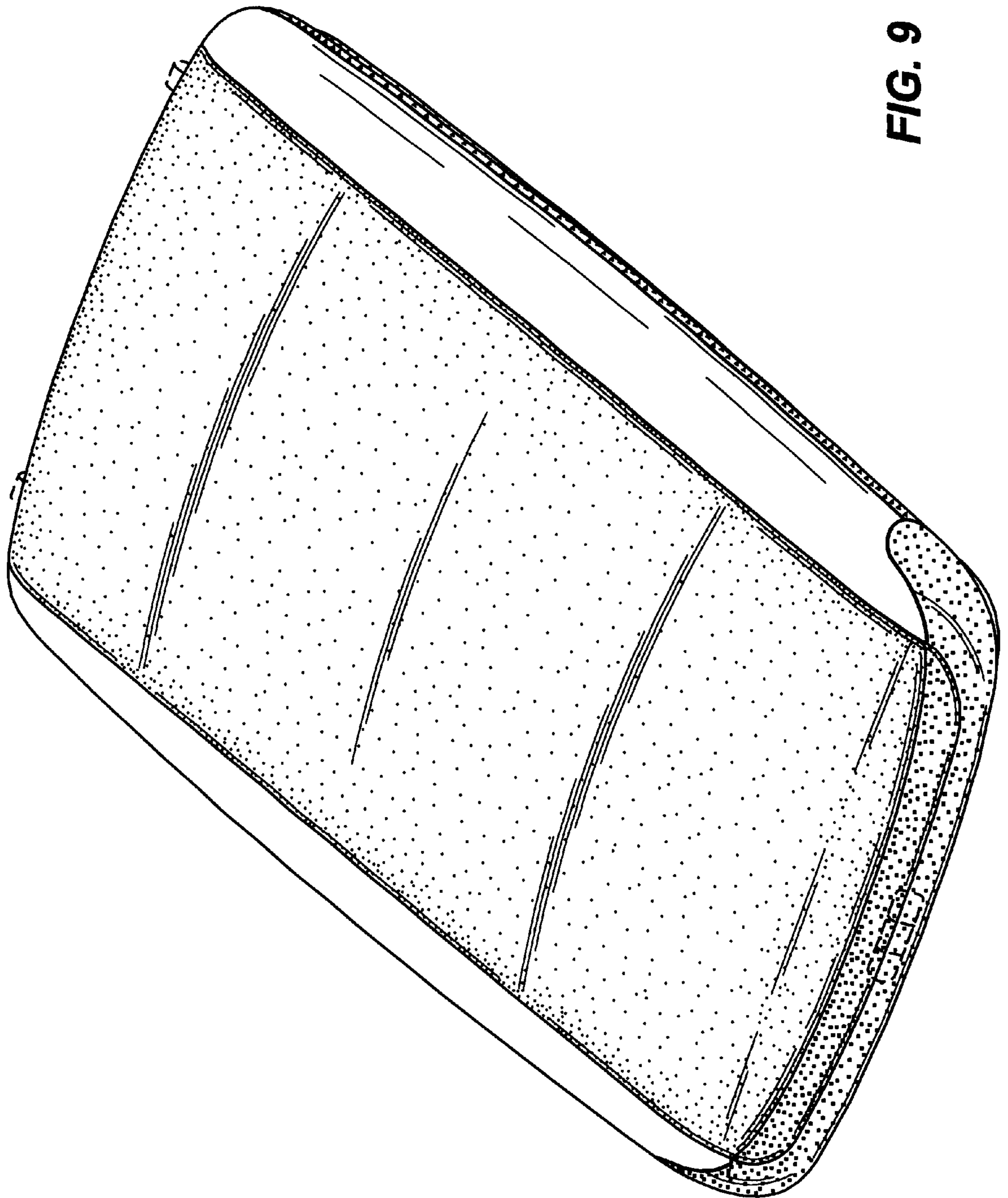

FIG. 9

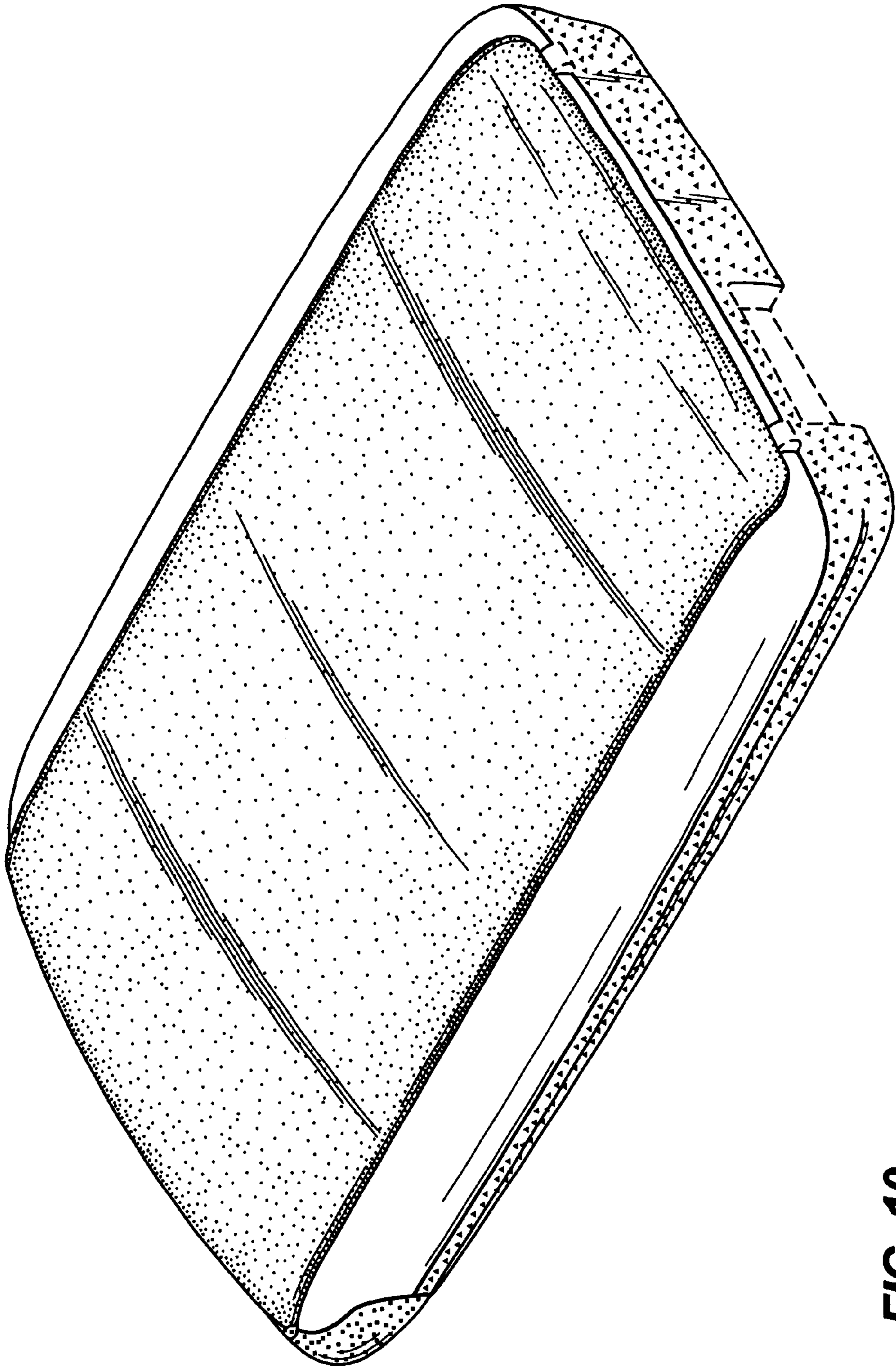

FIG. 10

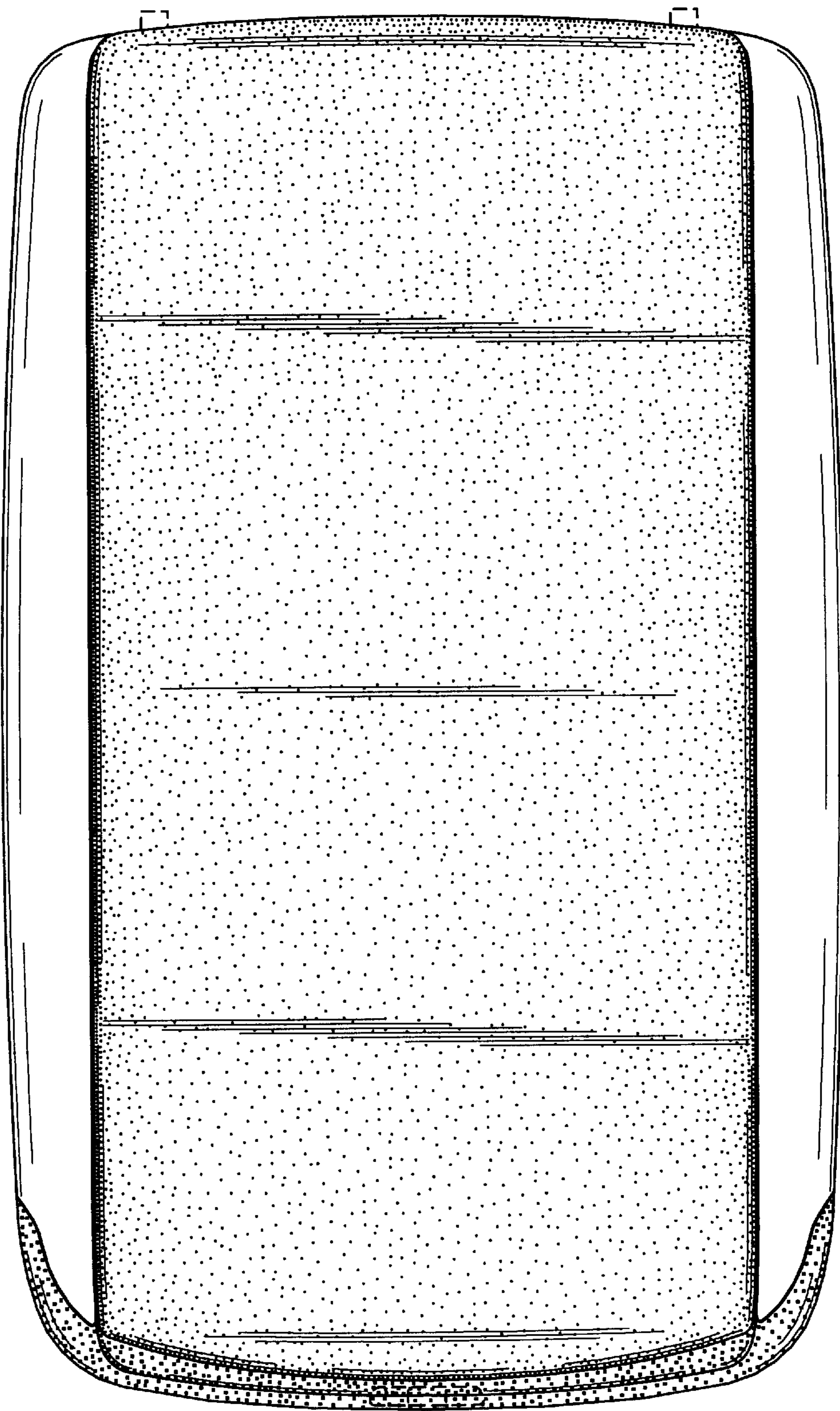

FIG. 11

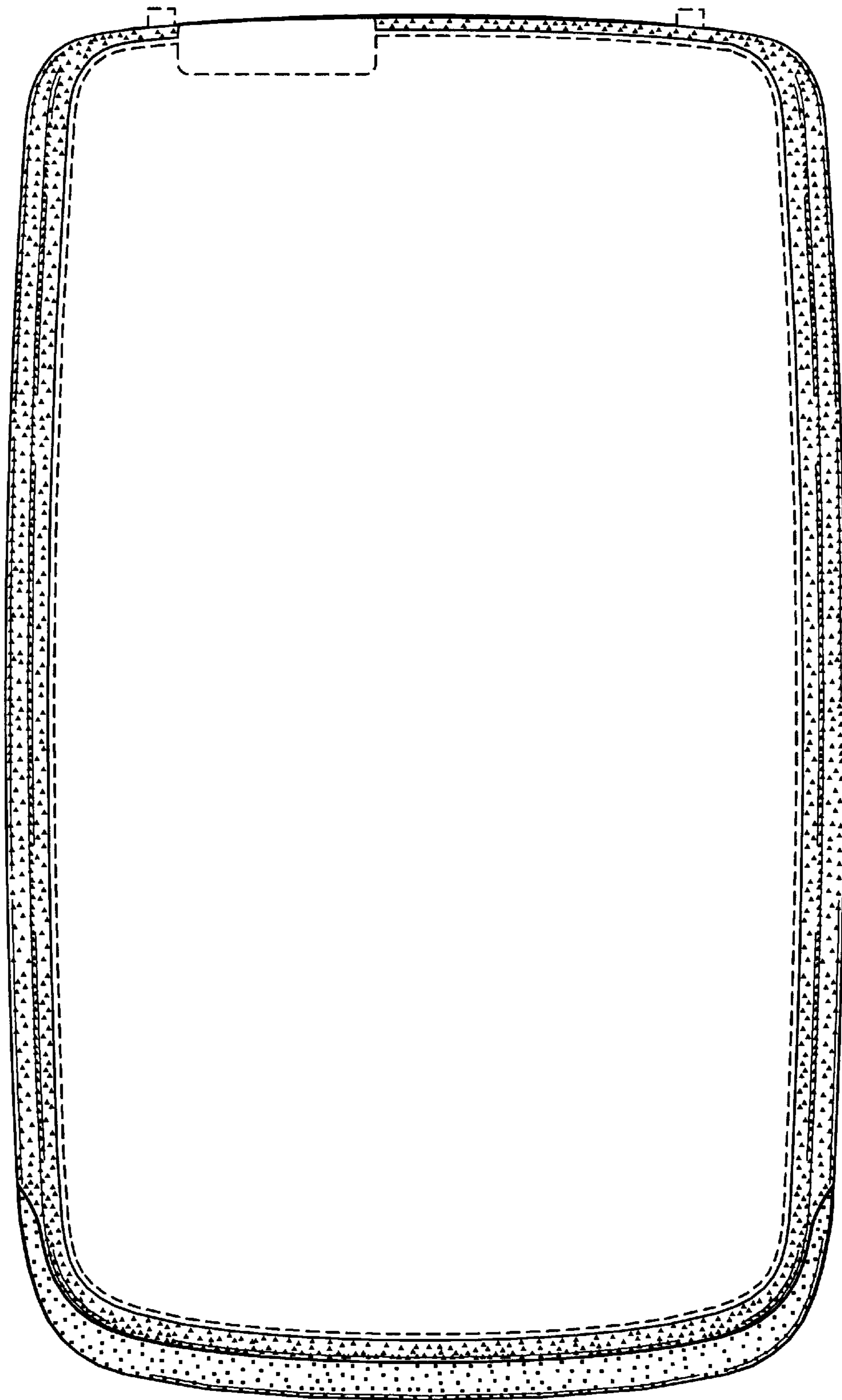

FIG. 12

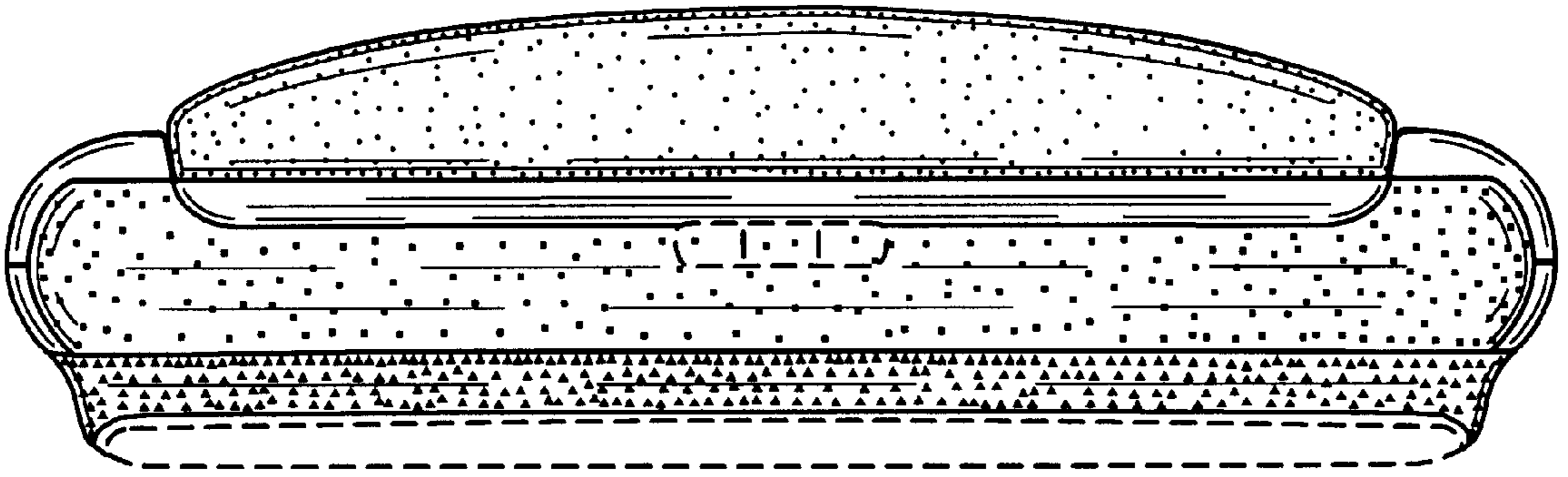

FIG. 13

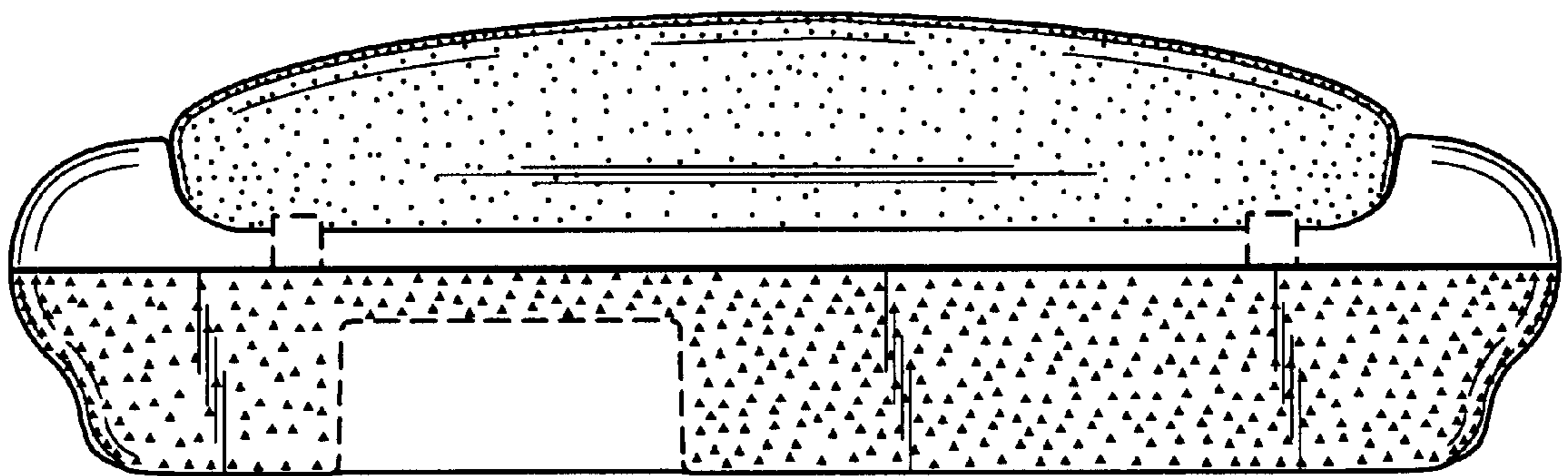

FIG. 14

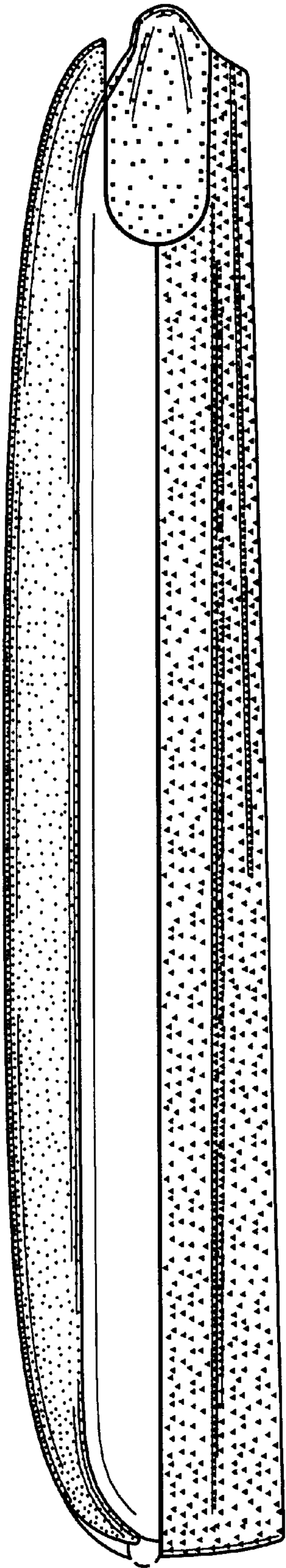

FIG. 15

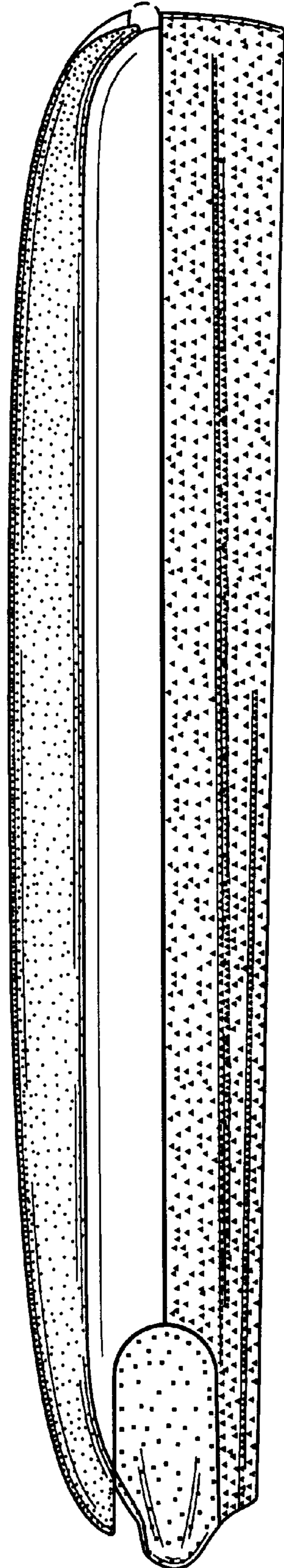

FIG. 16