



US00D478064S

(12) **United States Design Patent**
Jordan et al.

(10) **Patent No.: US D478,064 S**

(45) **Date of Patent: ** *Aug. 5, 2003**

(54) **AUDIO SPEAKER CABINET**

(75) Inventors: **Jeff B. Jordan**, Baton Rouge, LA (US);
Michael Craig Romero, Youngstown,
LA (US)

(73) Assignee: **Southern Audio Services, Inc.**, Baton
Rouge, LA (US)

(*) Notice: This patent is subject to a terminal dis-
claimer.

(**) Term: **14 Years**

(21) Appl. No.: **29/153,302**

(22) Filed: **Jan. 3, 2002**

(51) **LOC (7) Cl.** **14-01**

(52) **U.S. Cl.** **D14/212**

(58) **Field of Search** D14/204, 207,
D14/209-216; 181/144-145, 147-148,
150, 153, 157, 198-199; 381/300-302,
306, 333, 345, 361-364, 386-388

(56) **References Cited**

U.S. PATENT DOCUMENTS

D297,233 S * 8/1988 Livigni D14/215
D306,168 S * 2/1990 Caputo D14/204
5,105,906 A * 4/1992 Wegner 181/199

D330,376 S * 10/1992 Kawaguchi D14/212
D408,035 S * 4/1999 Denham D14/212
D431,551 S * 10/2000 Wegner D14/210

* cited by examiner

Primary Examiner—Nanda Bondade

(74) *Attorney, Agent, or Firm*—Roy, Kiesel, Keegan &
DeNicola

(57) **CLAIM**

The ornamental design for the audio speaker cabinet, as
shown.

DESCRIPTION

FIG. 1 is a front view of the audio speaker cabinet of this
invention.

FIG. 2 is a rear view of the audio speaker cabinet of this
invention.

FIG. 3 is a side view of the audio speaker cabinet of this
invention.

FIG. 4 is a view of the opposite side audio speaker cabinet
of this invention as illustrated in FIG. 3.

FIG. 5 is a top view of the audio speaker cabinet of this
invention.

FIG. 6 is a bottom view of the audio speaker cabinet of this
invention; and,

FIG. 7 is a three-quarter perspective view of the audio
speaker cabinet of this invention.

1 Claim, 3 Drawing Sheets

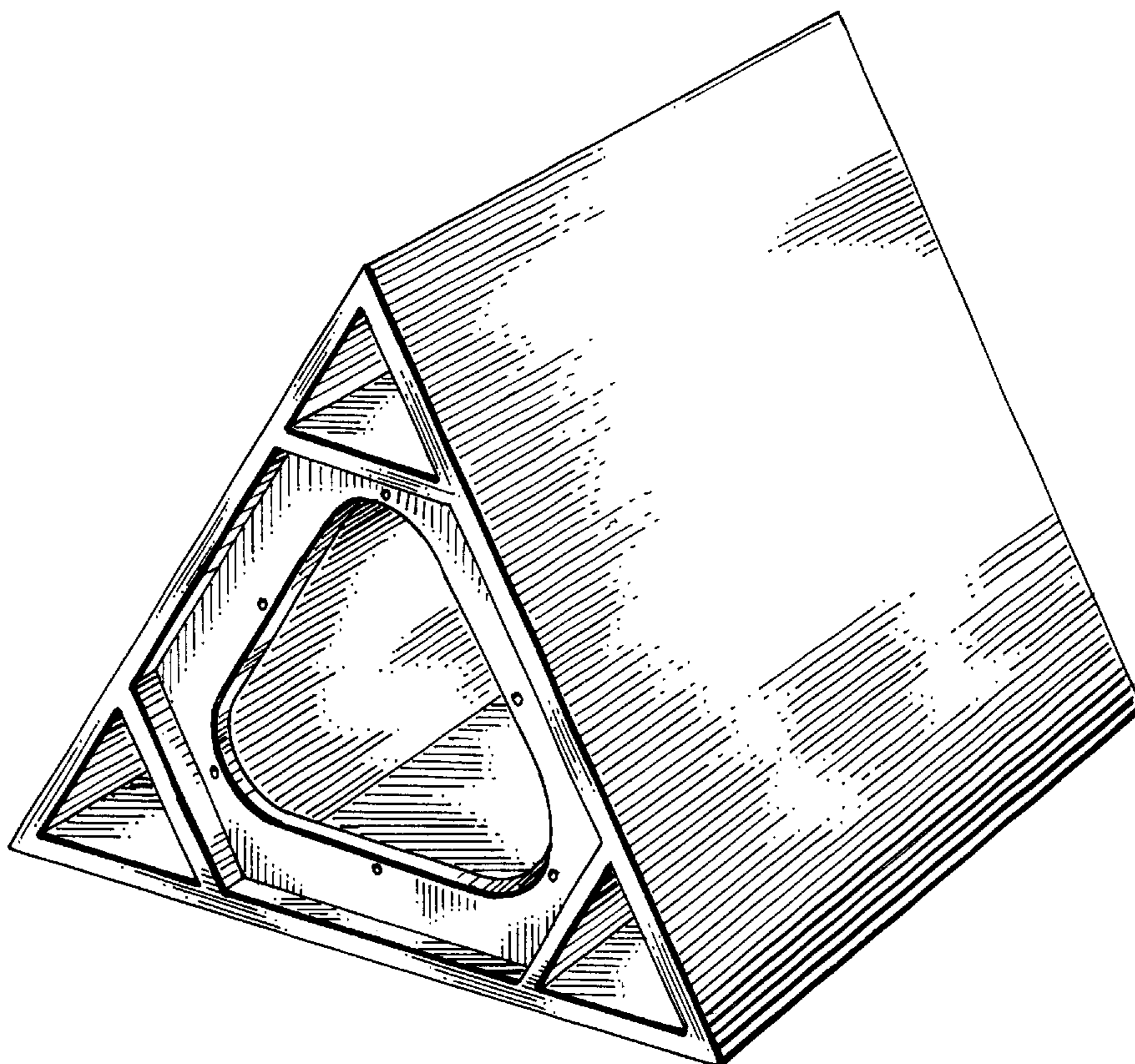

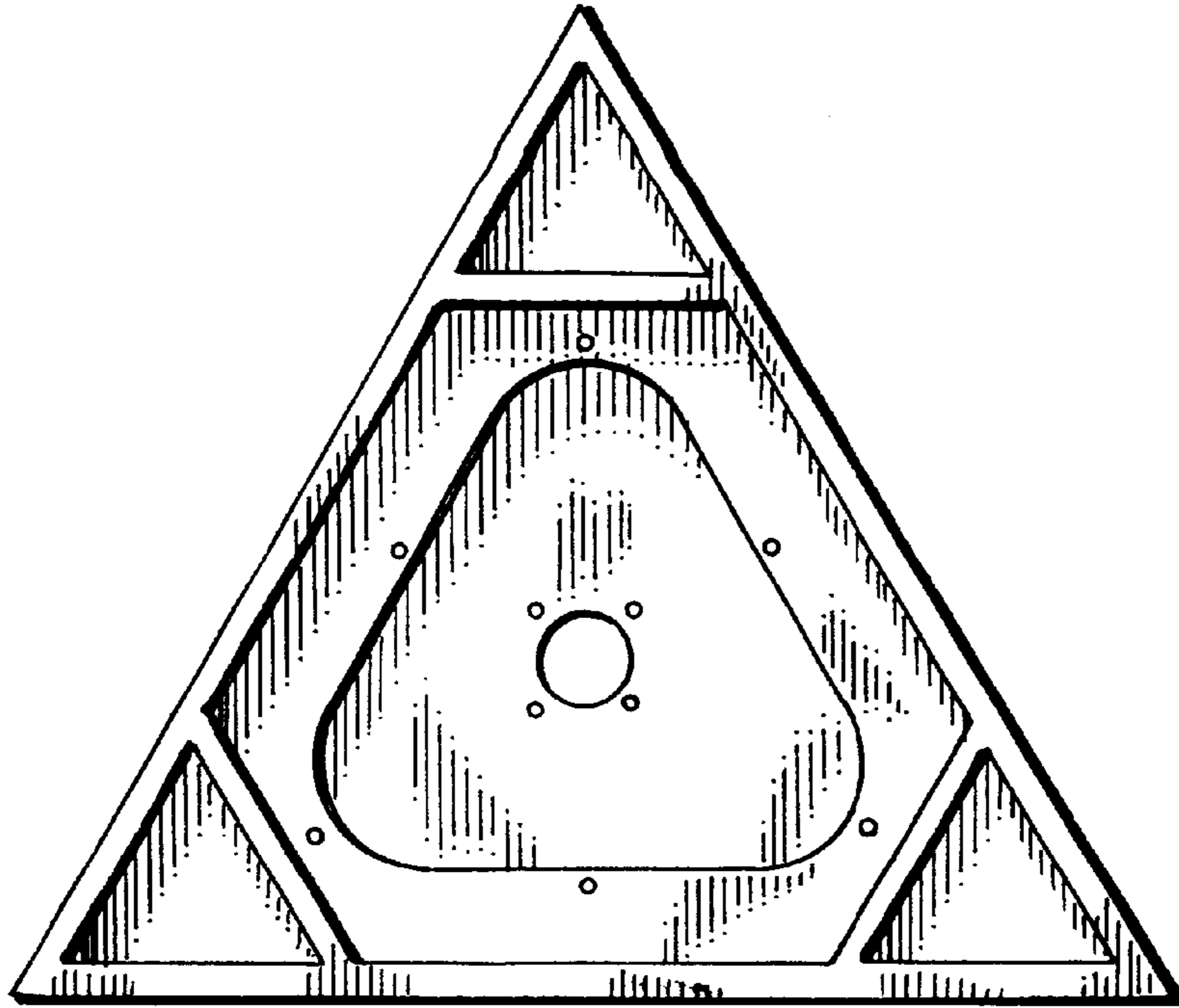

FIG. 1.

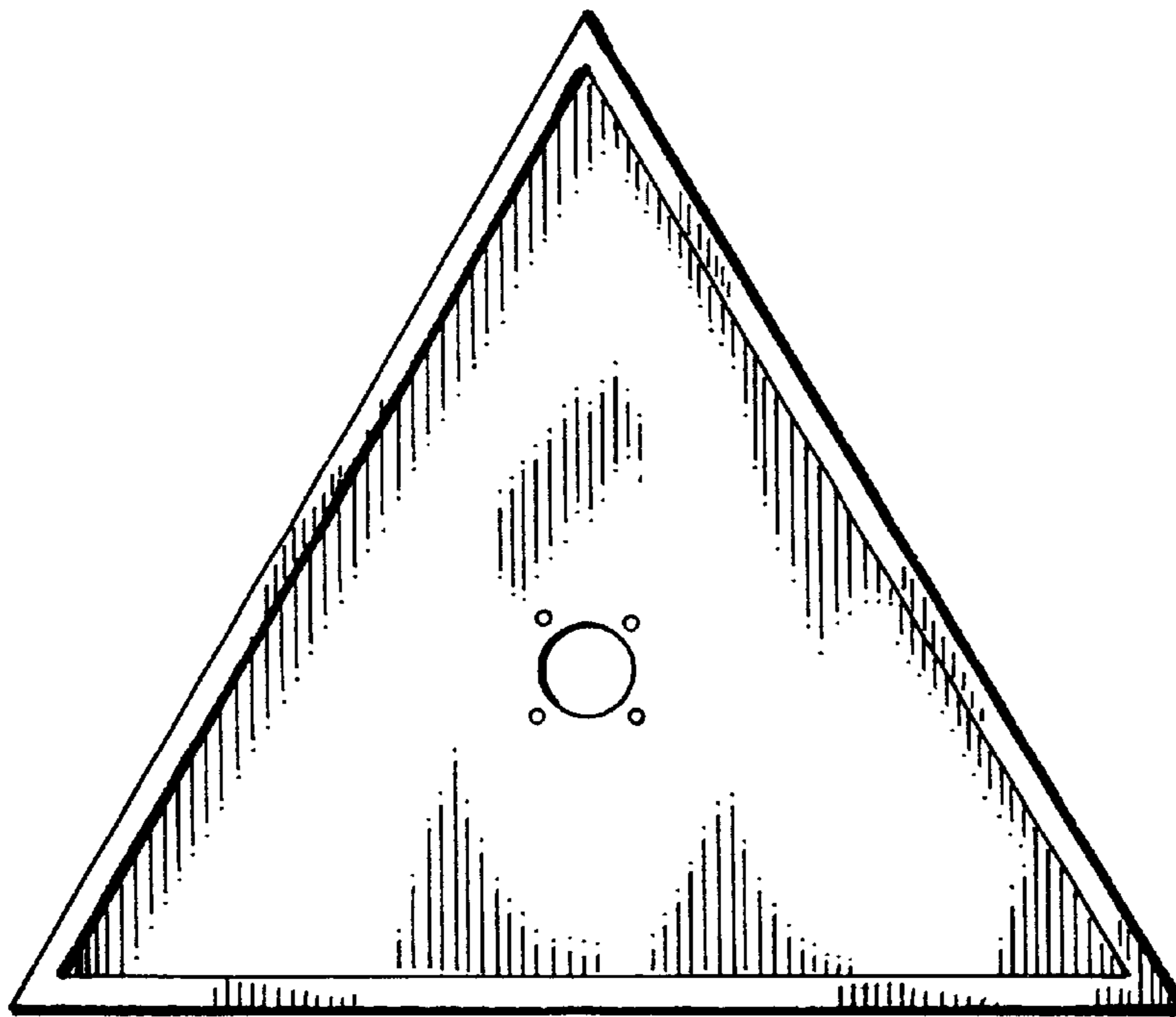

FIG. 2.

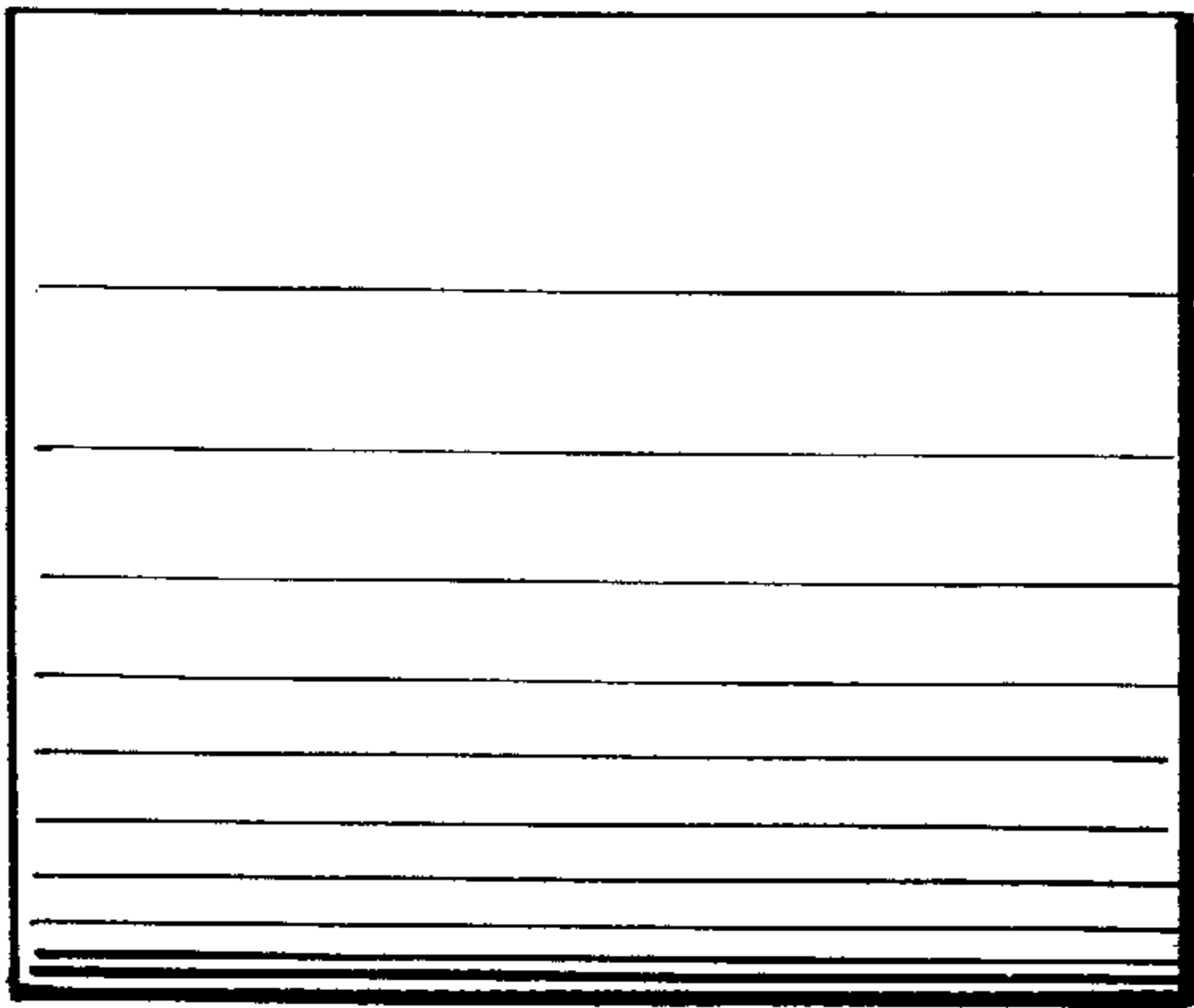

FIG. 3.

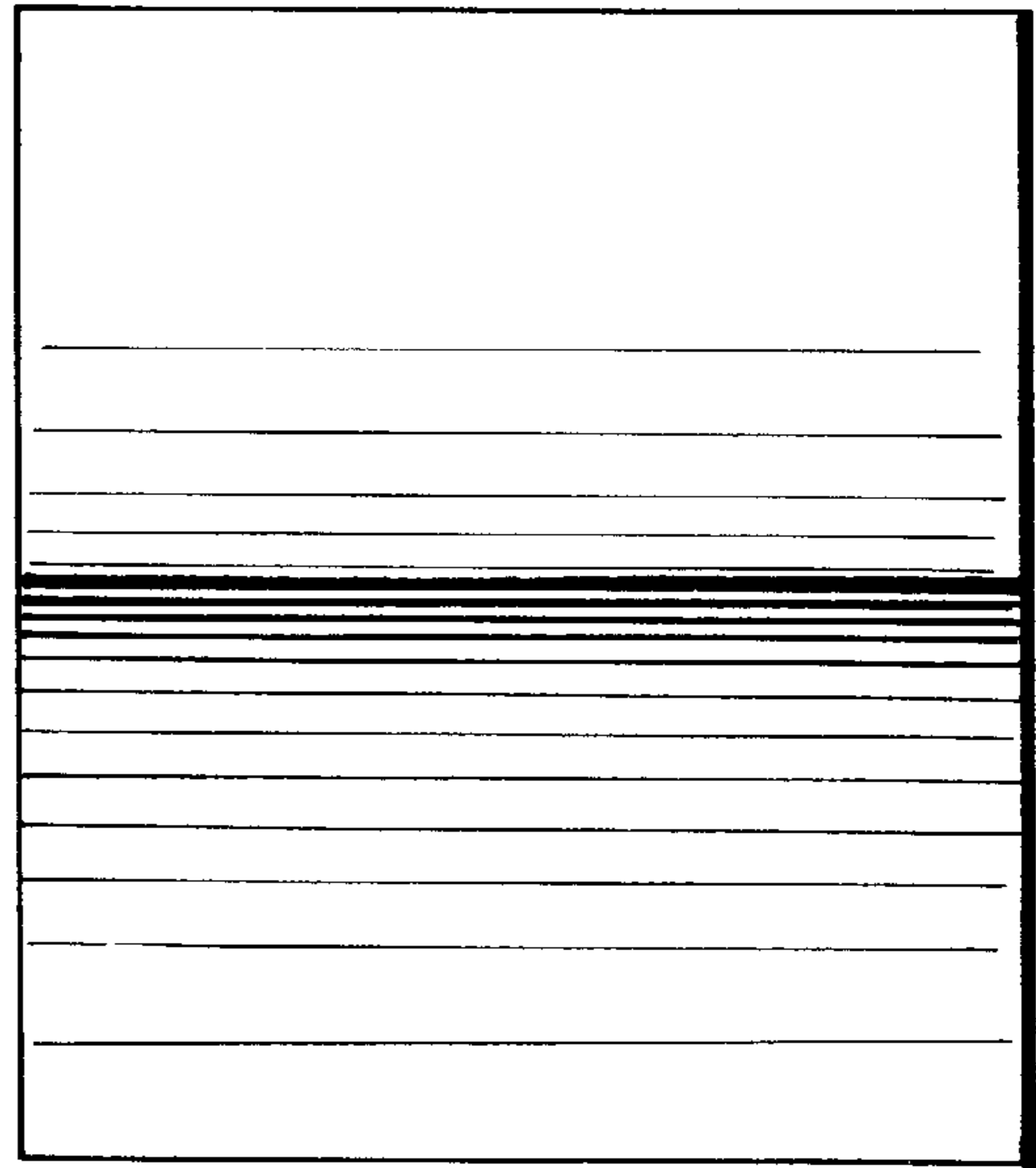

FIG. 5.

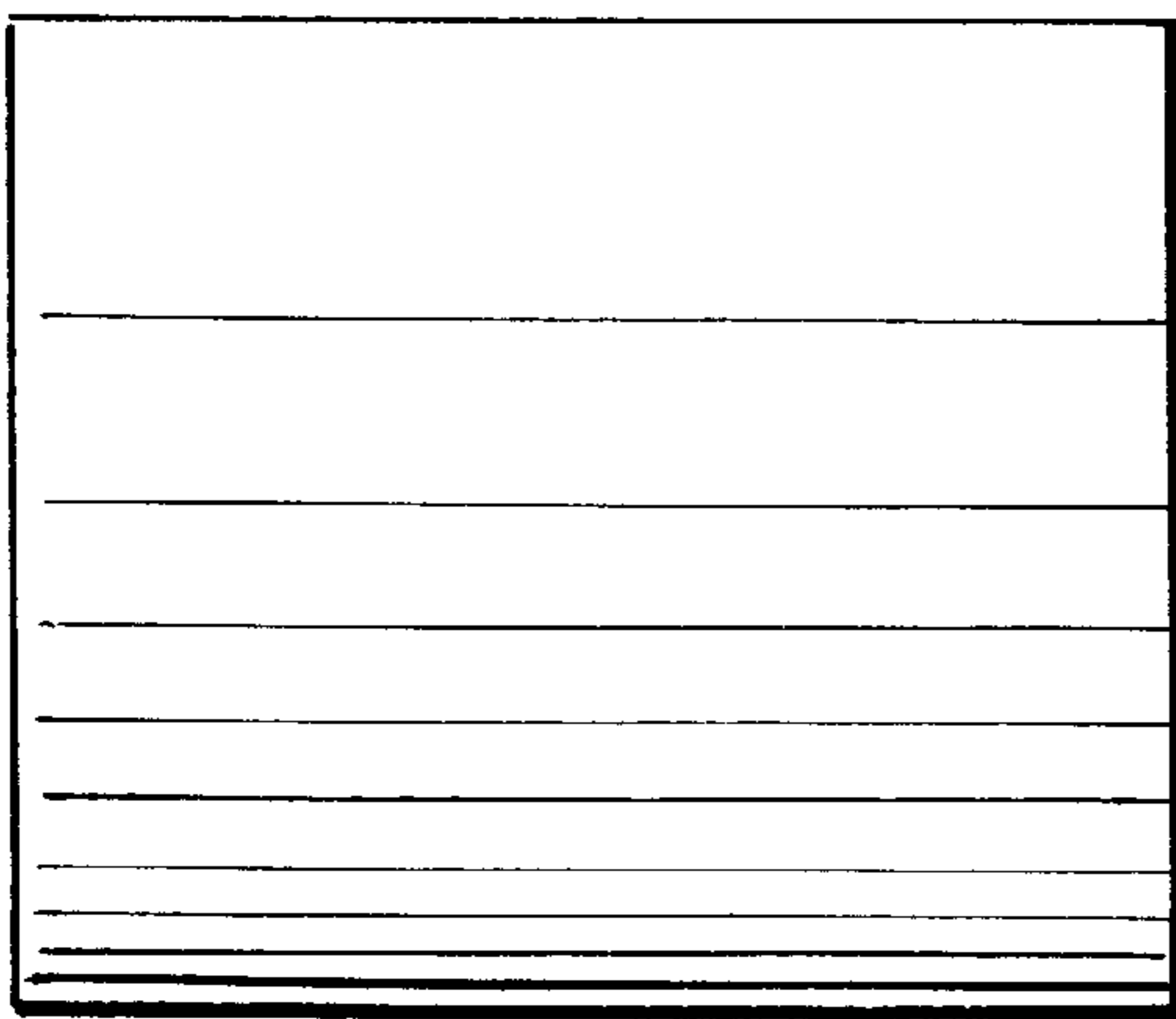

FIG. 4.

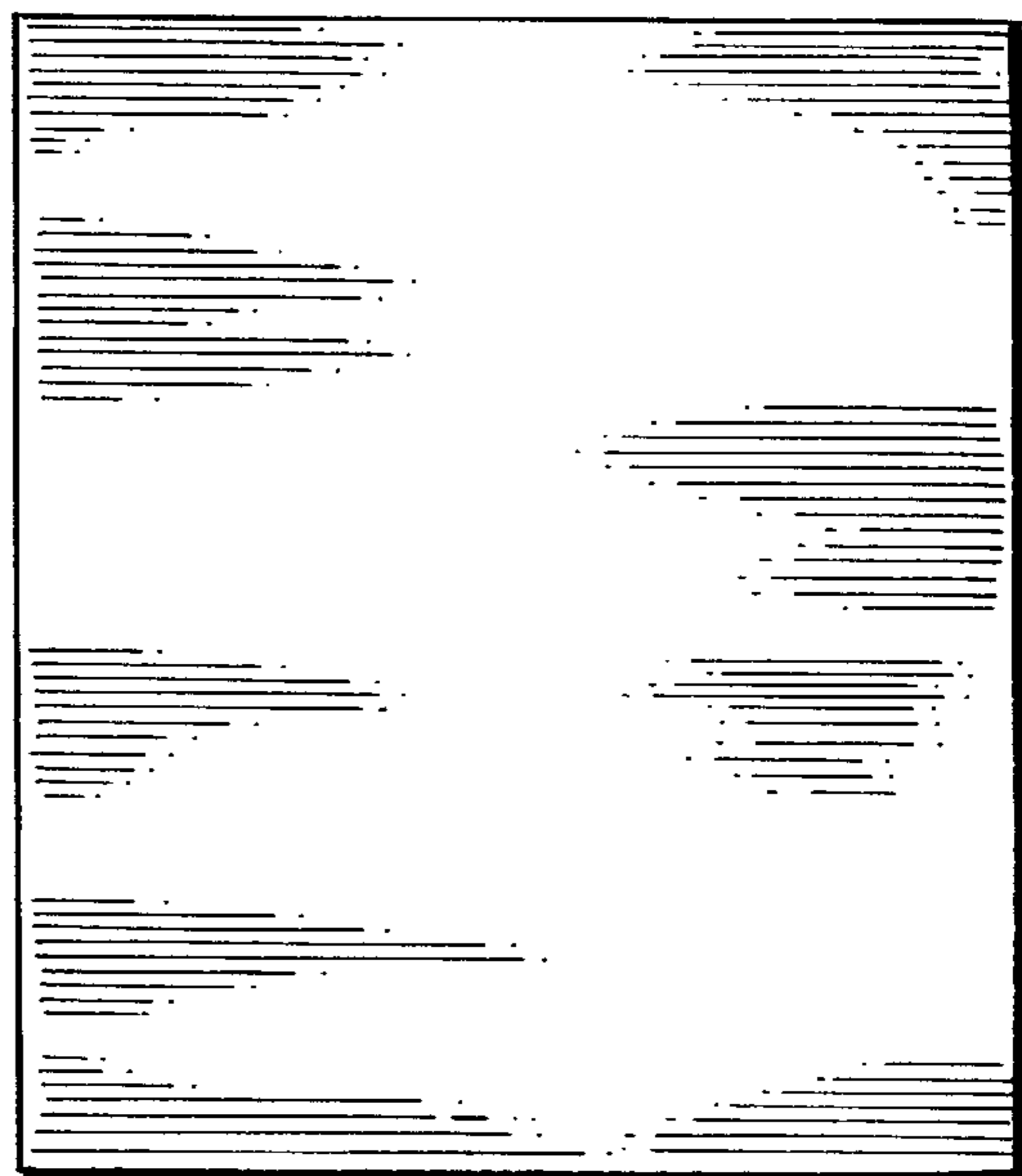

FIG. 6.

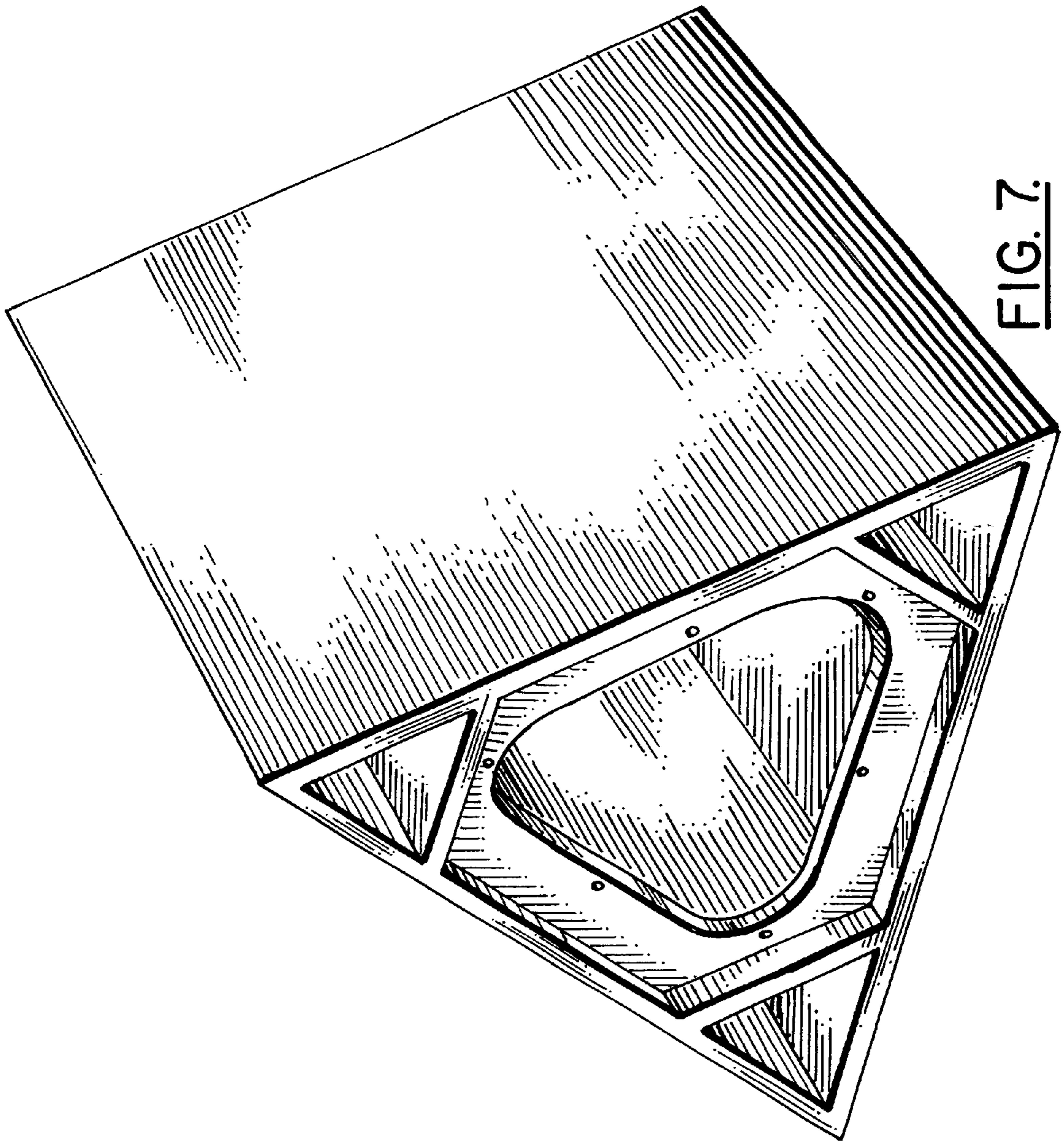

FIG. 7.