



US00D478033S

(12) **United States Design Patent**
Tsai

(10) **Patent No.:** **US D478,033 S**

(45) **Date of Patent:** **** Aug. 5, 2003**

(54) **WINDSHIELD WASHER**

(76) **Inventor:** **Hsi-Lung Tsai**, No. 248, Sec. 1,
Chung-Shan Rd., Chiao-Tou Village,
Hua-Tan Hsiang, Changhua Hsien (TW)

(**) **Term:** **14 Years**

(21) **Appl. No.:** **29/174,380**

(22) **Filed:** **Jan. 15, 2003**

(51) **LOC (7) Cl.** **12-06**

(52) **U.S. Cl.** **D12/220**

(58) **Field of Search** D12/219, 220,
D12/400, 162; 239/284.1, 284.2, 600-601,
565, 587.4, 589, 597, 548-553.5; 285/214-216,
194; 15/250.01, 322; D11/55, 83, 136;
D14/232; D9/441, 451; D23/213

(56) **References Cited**

U.S. PATENT DOCUMENTS

D48,894 S * 4/1916 Higgins D9/451
D53,428 S * 6/1919 Rustant D9/451
D53,467 S * 6/1919 Rustant D9/451

D53,468 S * 6/1919 Rustant D9/451
D167,527 S * 8/1952 Neufeld D12/220
D417,181 S * 11/1999 Raghu D12/220
D424,506 S * 5/2000 Kondo D12/220
D458,890 S * 6/2002 Hsieh D12/220
D470,095 S * 2/2003 Wang et al. D12/220

* cited by examiner

Primary Examiner—Stacia Cadmus

(74) *Attorney, Agent, or Firm*—Dellett and Walters

(57) **CLAIM**

The ornamental design for a windshield washer, as shown.

DESCRIPTION

FIG. 1 is a perspective view of a windshield washer, showing my new design;
FIG. 2 is a front elevational view thereof;
FIG. 3 is a rear elevational view thereof;
FIG. 4 is a left side elevational view thereof;
FIG. 5 is a right side elevational view thereof;
FIG. 6 is a top plan view thereof; and,
FIG. 7 is a bottom plan view thereof.

1 Claim, 6 Drawing Sheets

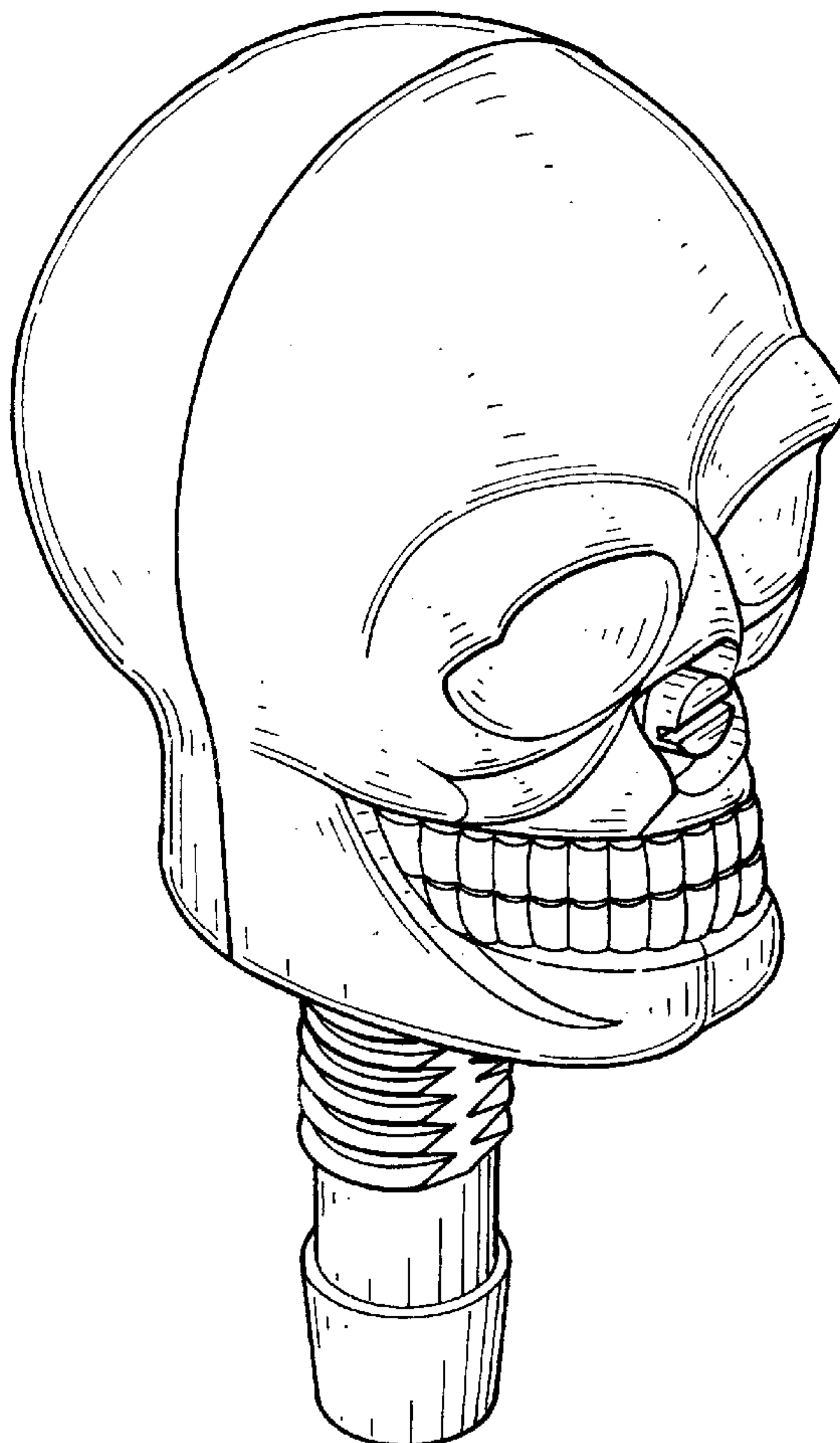

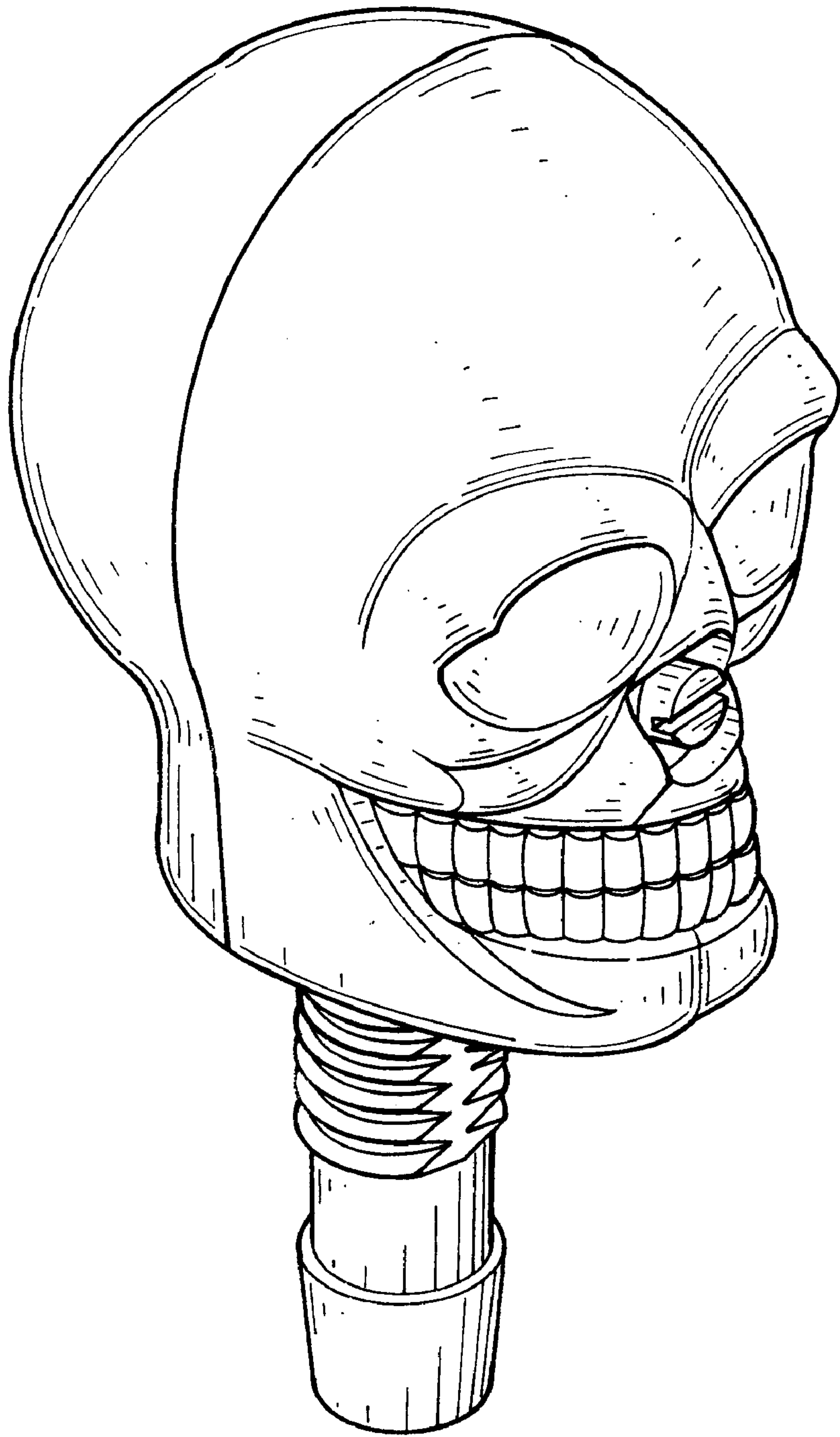

FIG. 1

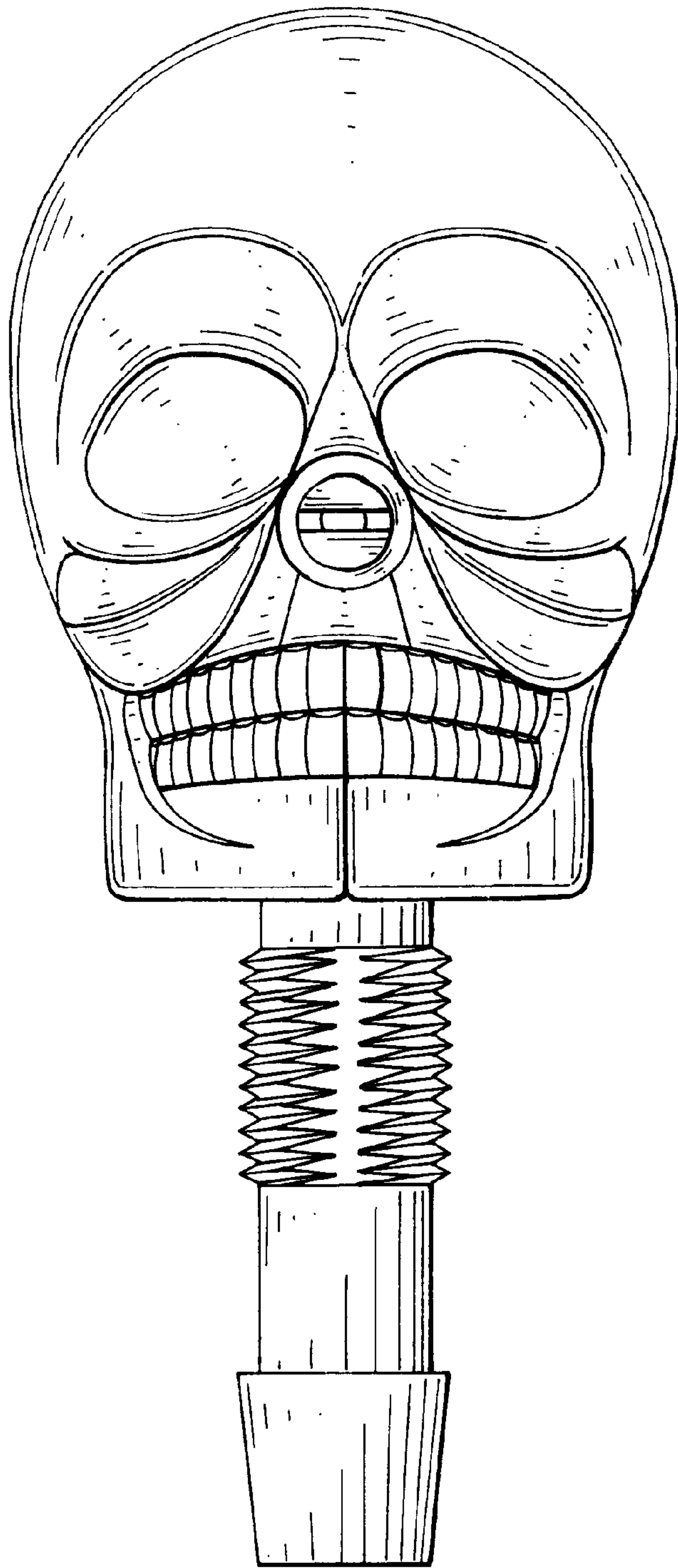

FIG. 2

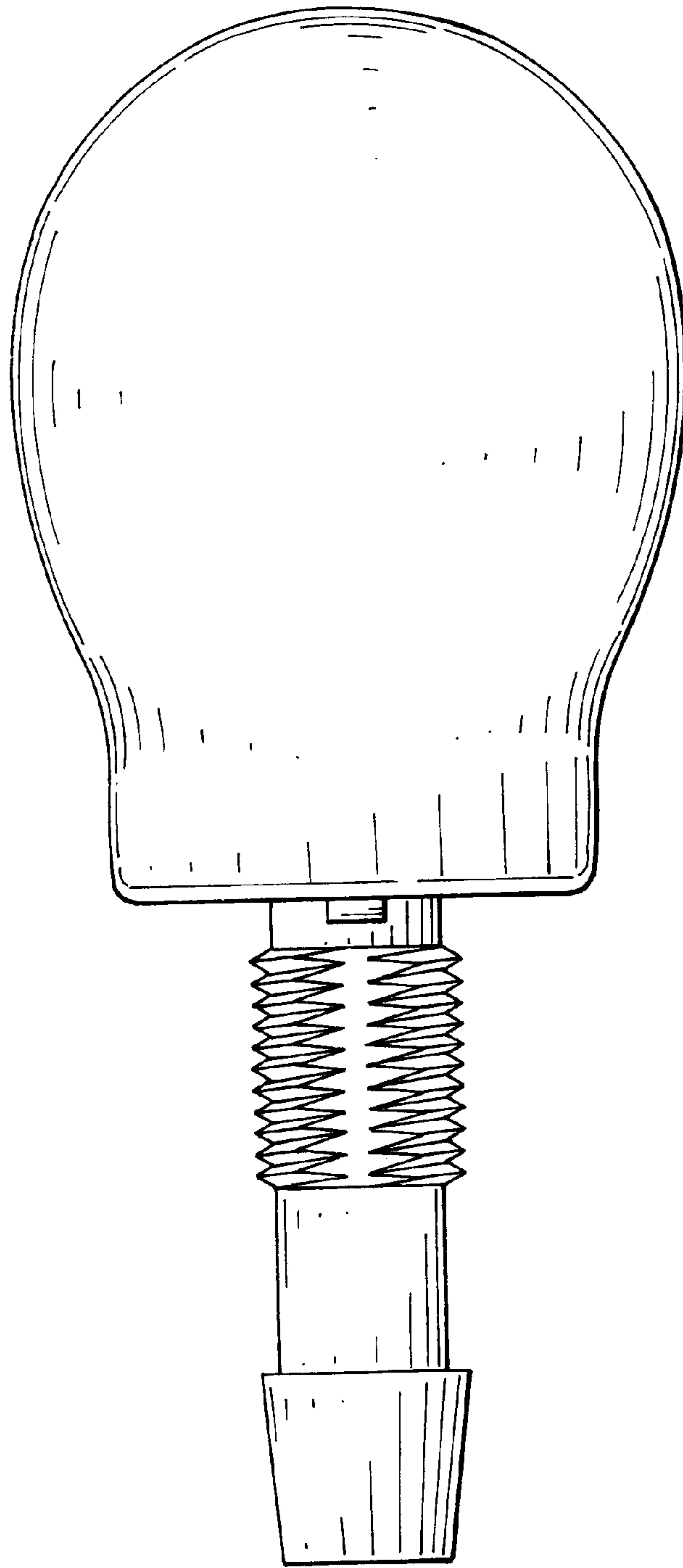

FIG. 3

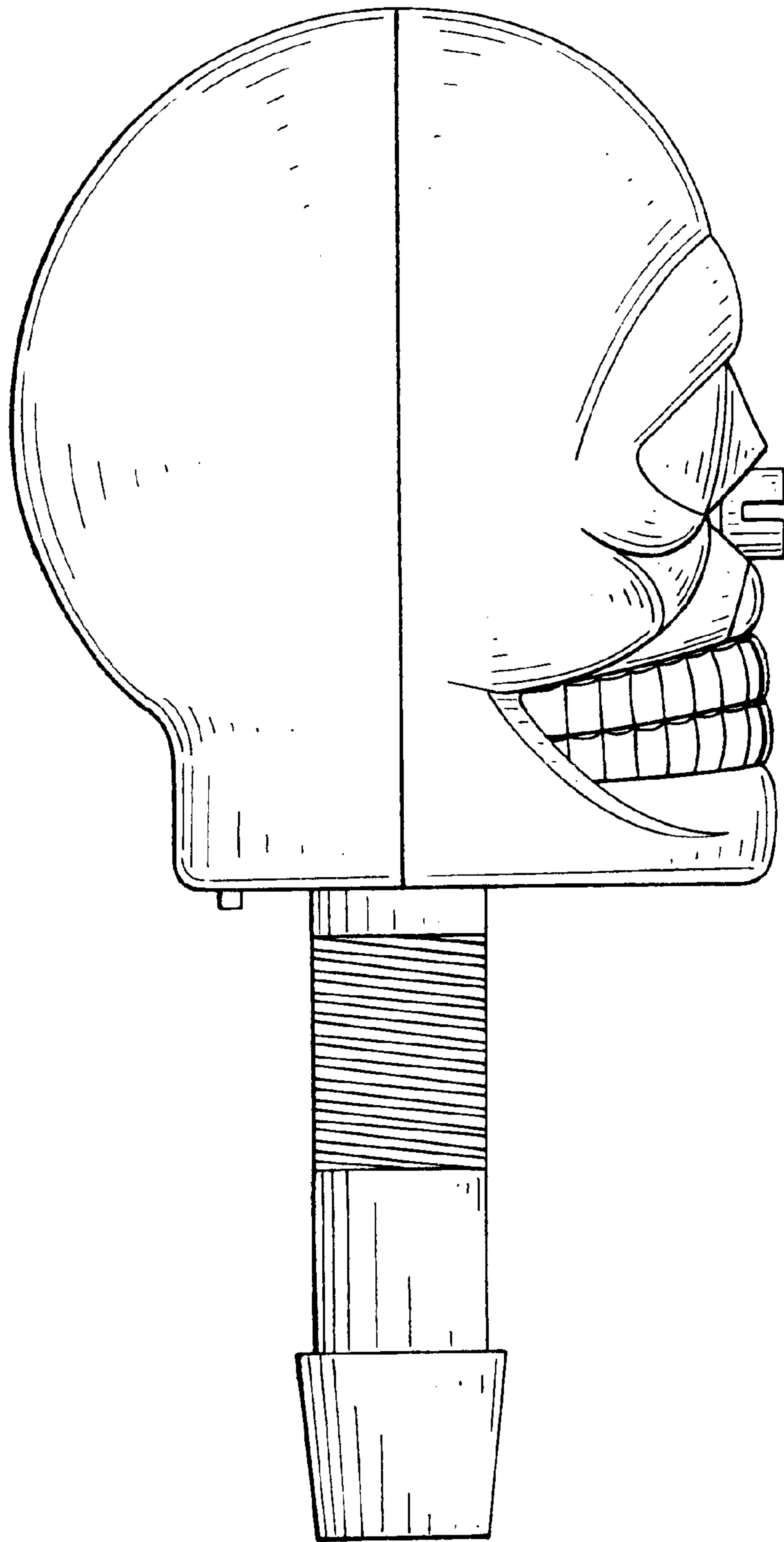

FIG. 4

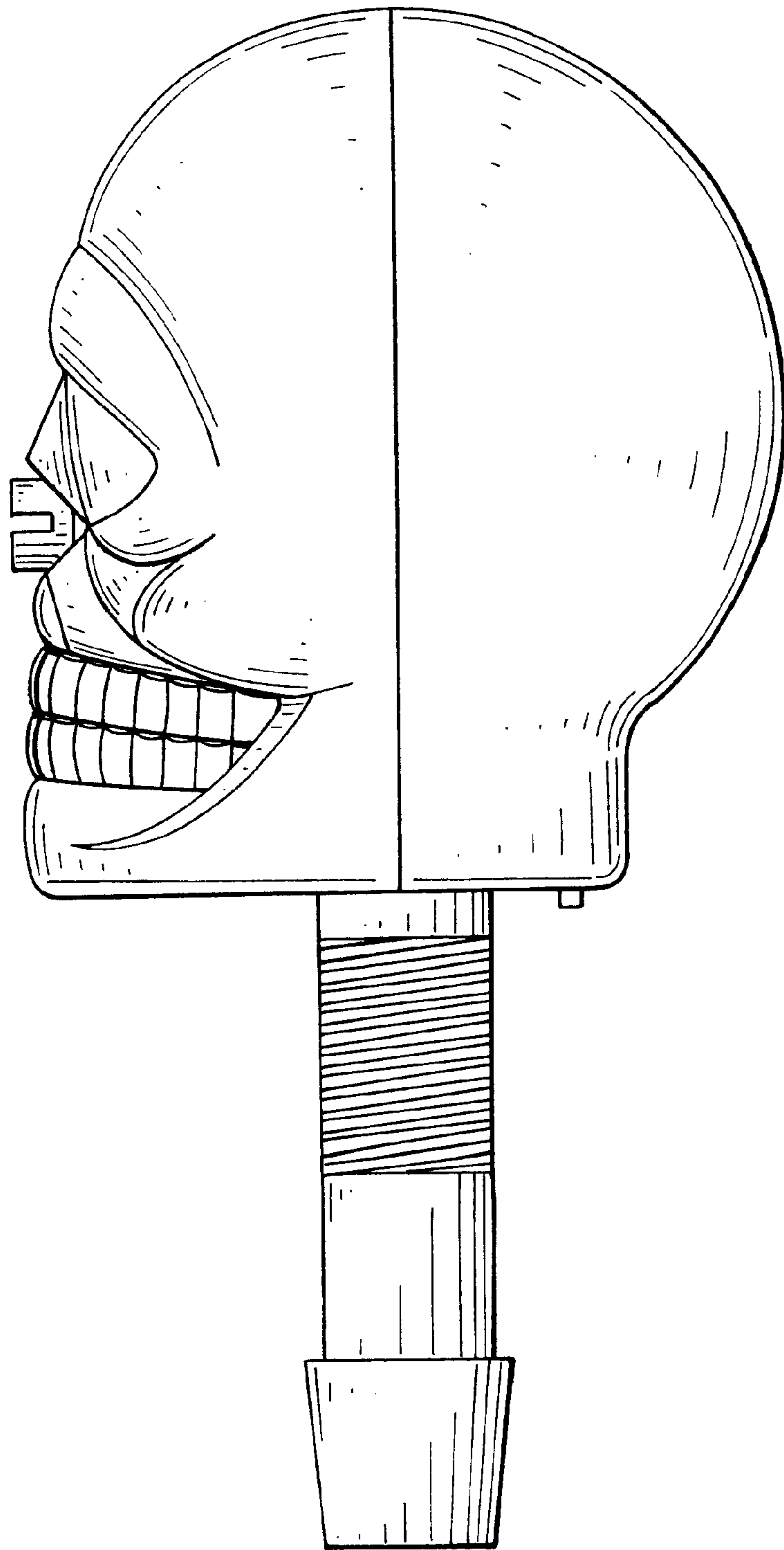

FIG. 5

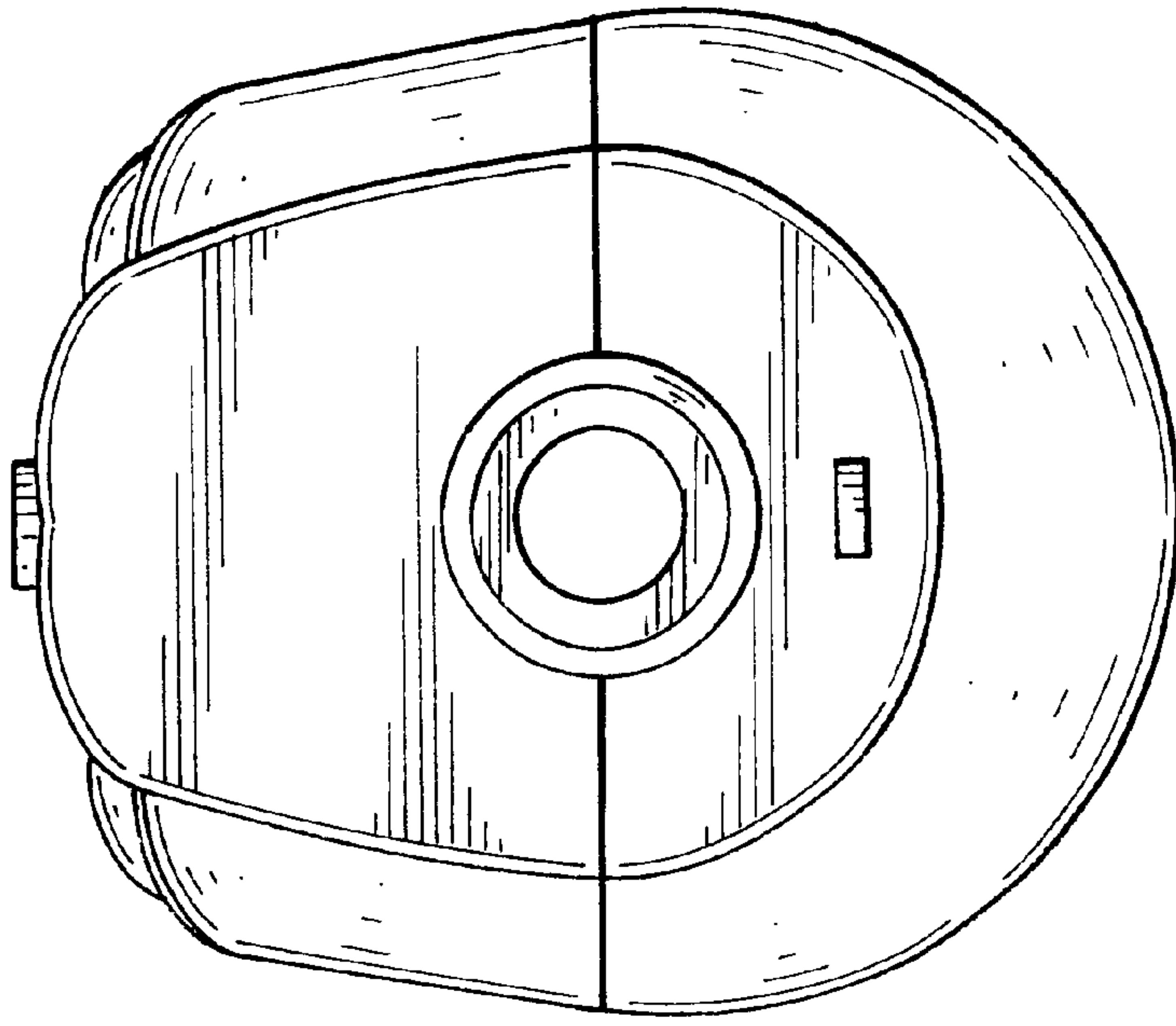

FIG. 7

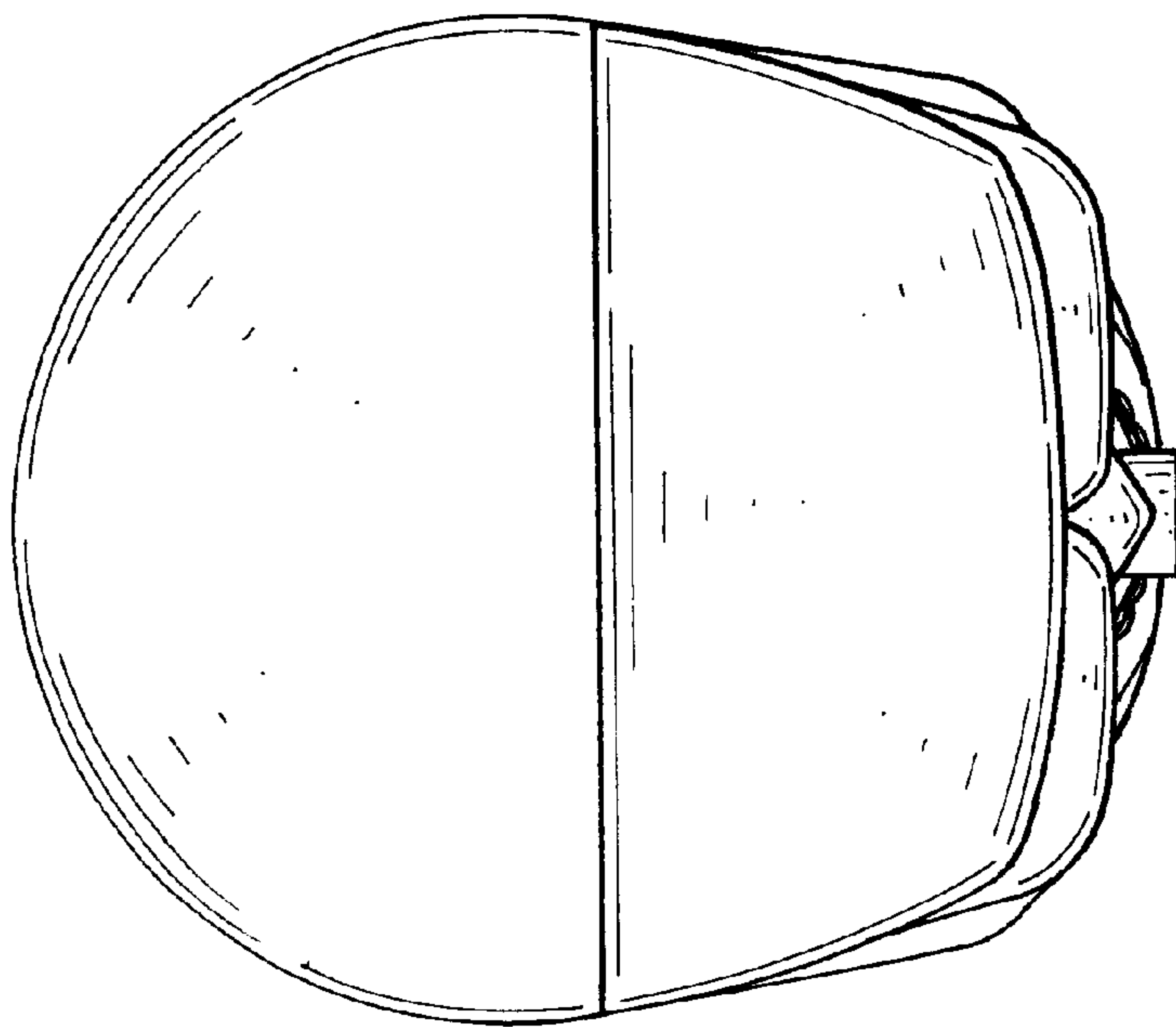

FIG. 6