



US00D478029S

(12) **United States Design Patent**
Chiang

(10) **Patent No.:** **US D478,029 S**

(45) **Date of Patent:** **** Aug. 5, 2003**

(54) **ENGINE HOOD FOR AUTOMOBILES**

(75) **Inventor:** **Tommy Chiang, Taipei (TW)**

(73) **Assignee:** **Grand HC Auto Tooling Corp., Taipei (TW)**

(**) **Term:** **14 Years**

(21) **Appl. No.:** **29/171,409**

(22) **Filed:** **Nov. 22, 2002**

(51) **LOC (7) Cl.** **12-16**

(52) **U.S. Cl.** **D12/173**

(58) **Field of Search** D12/173, 90-92,
D12/196; 180/69.2, 69.21, 69.22

(56) **References Cited**

U.S. PATENT DOCUMENTS

- D416,524 S * 11/1999 Gabath D12/173
- D427,122 S * 6/2000 Hoyle, Jr. D12/173
- D430,084 S * 8/2000 Hoyle, Jr. D12/173

- D433,359 S * 11/2000 Hoyle, Jr. D12/173
- D446,175 S * 8/2001 Hoyle, Jr. D12/173
- D446,176 S * 8/2001 Akashi et al. D12/173

* cited by examiner

Primary Examiner—Melody N. Brown

(74) *Attorney, Agent, or Firm*—Leong C. Lei

(57) **CLAIM**

The ornamental design for an engine hood for automobiles, as shown and described.

DESCRIPTION

FIG. 1 is perspective view of an engine hood for automobiles showing my new design;
 FIG. 2 is a front elevation view thereof;
 FIG. 3 is a rear elevation view thereof;
 FIG. 4 is a left side elevation view thereof;
 FIG. 5 is a right side elevation view thereof;
 FIG. 6 is a top plan view thereof; and,
 FIG. 7 is a bottom plan view thereof.

1 Claim, 5 Drawing Sheets

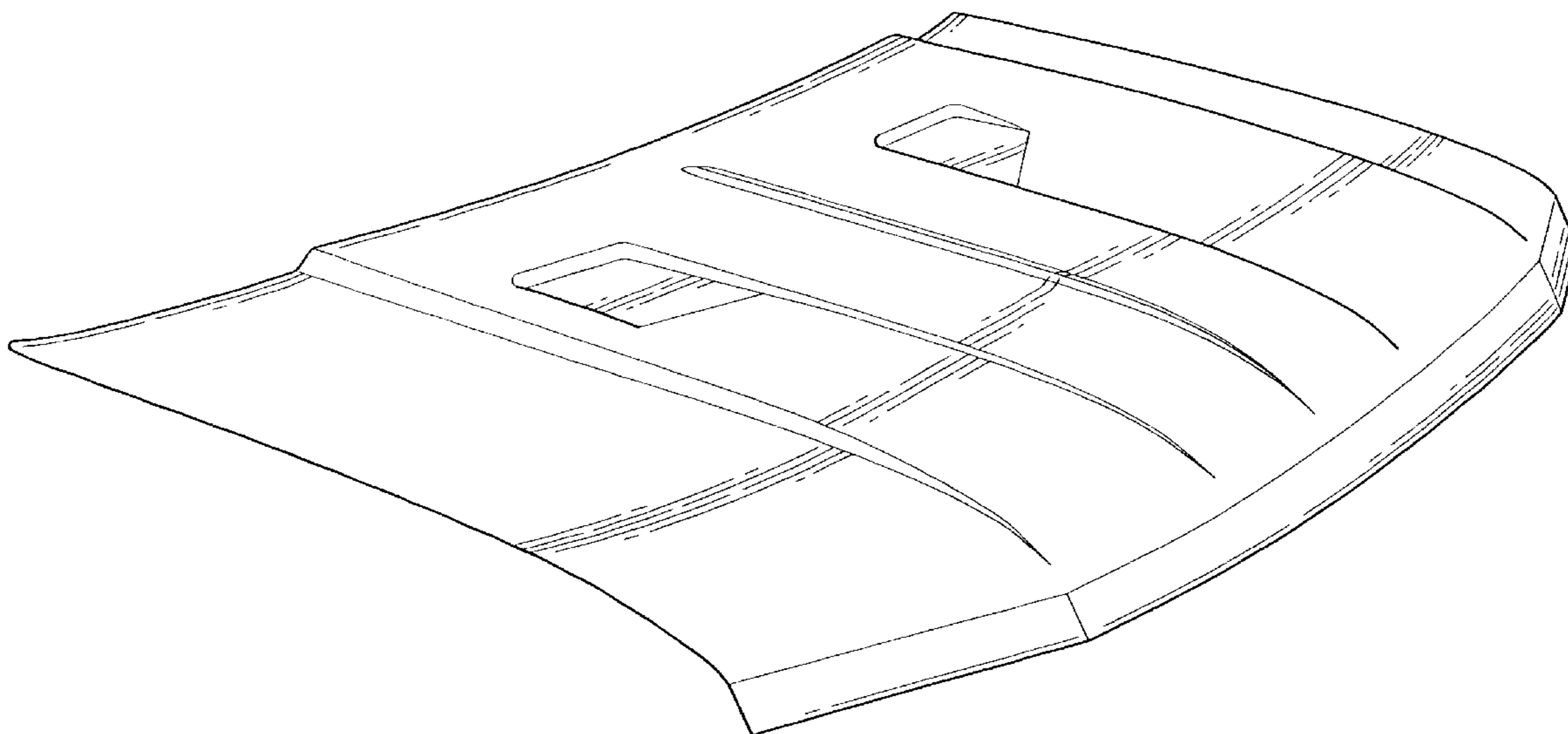

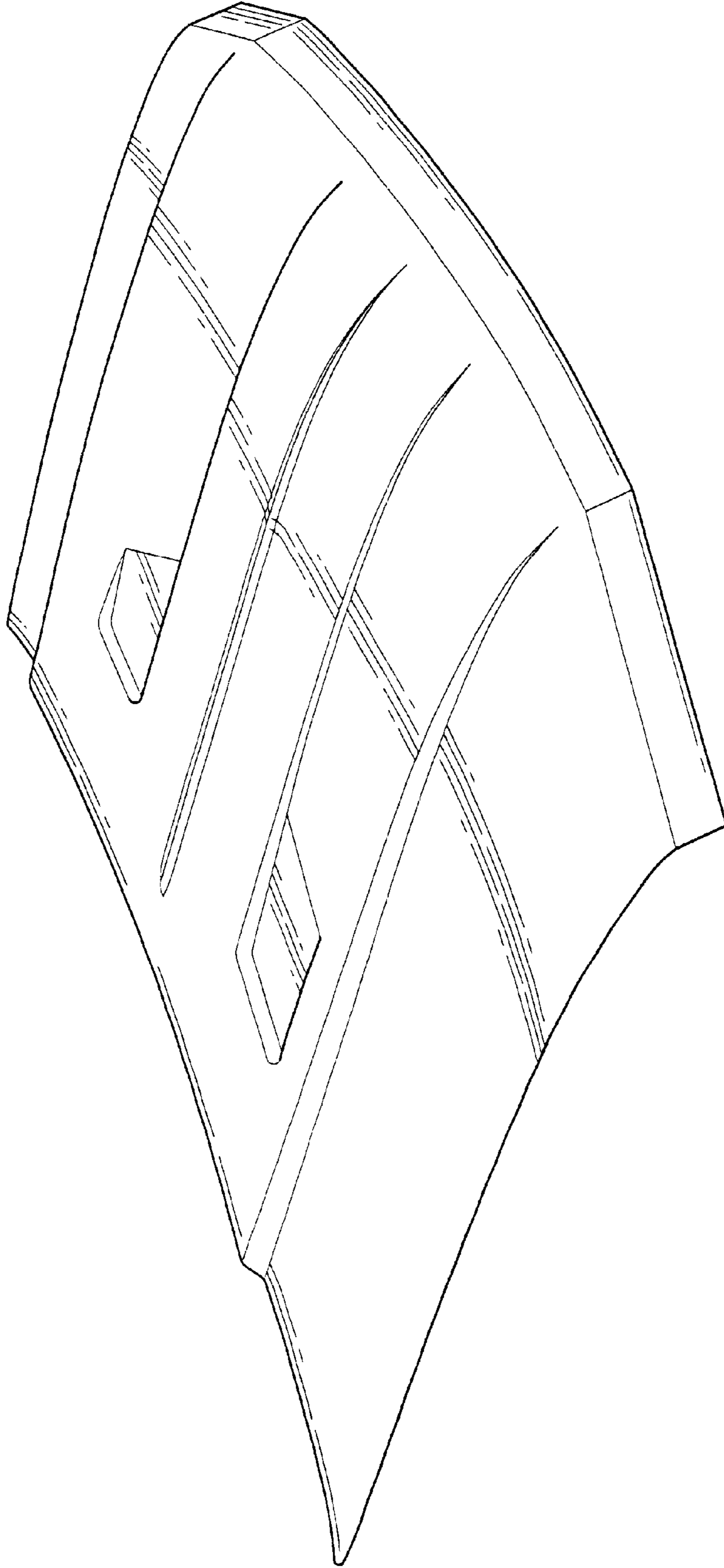

FIG. 1

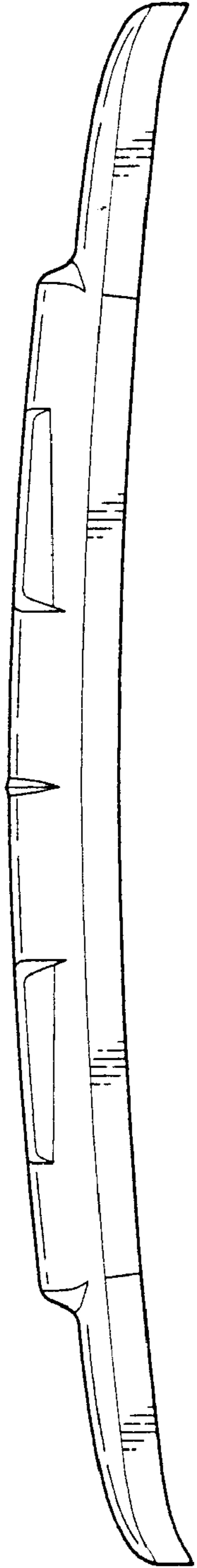

FIG. 2

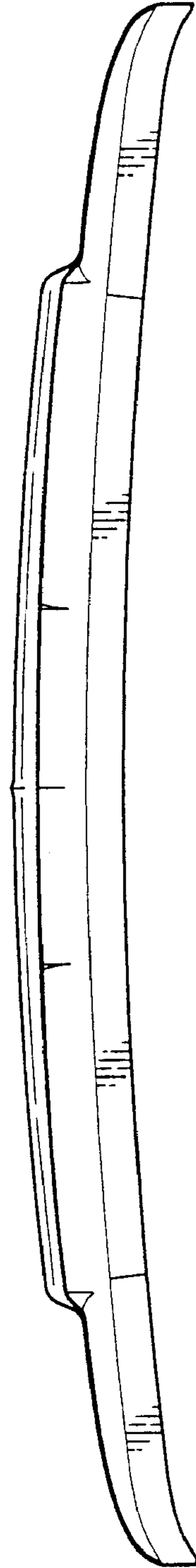

FIG. 3

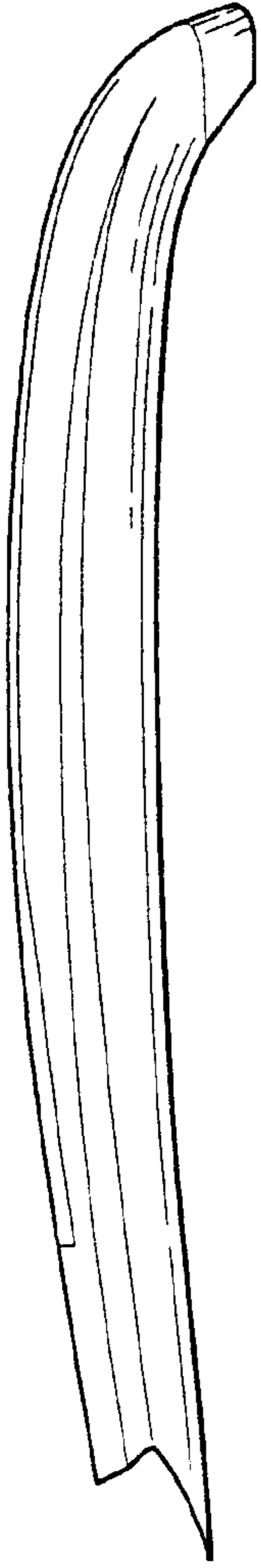

FIG. 4

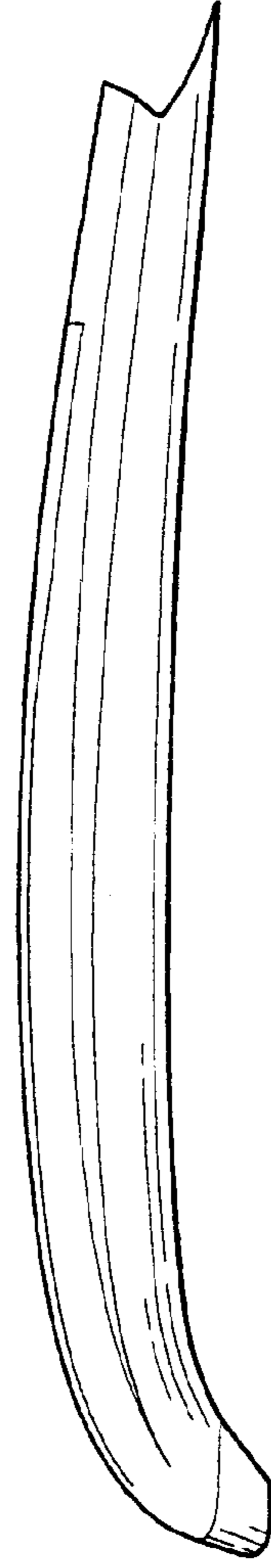

FIG. 5

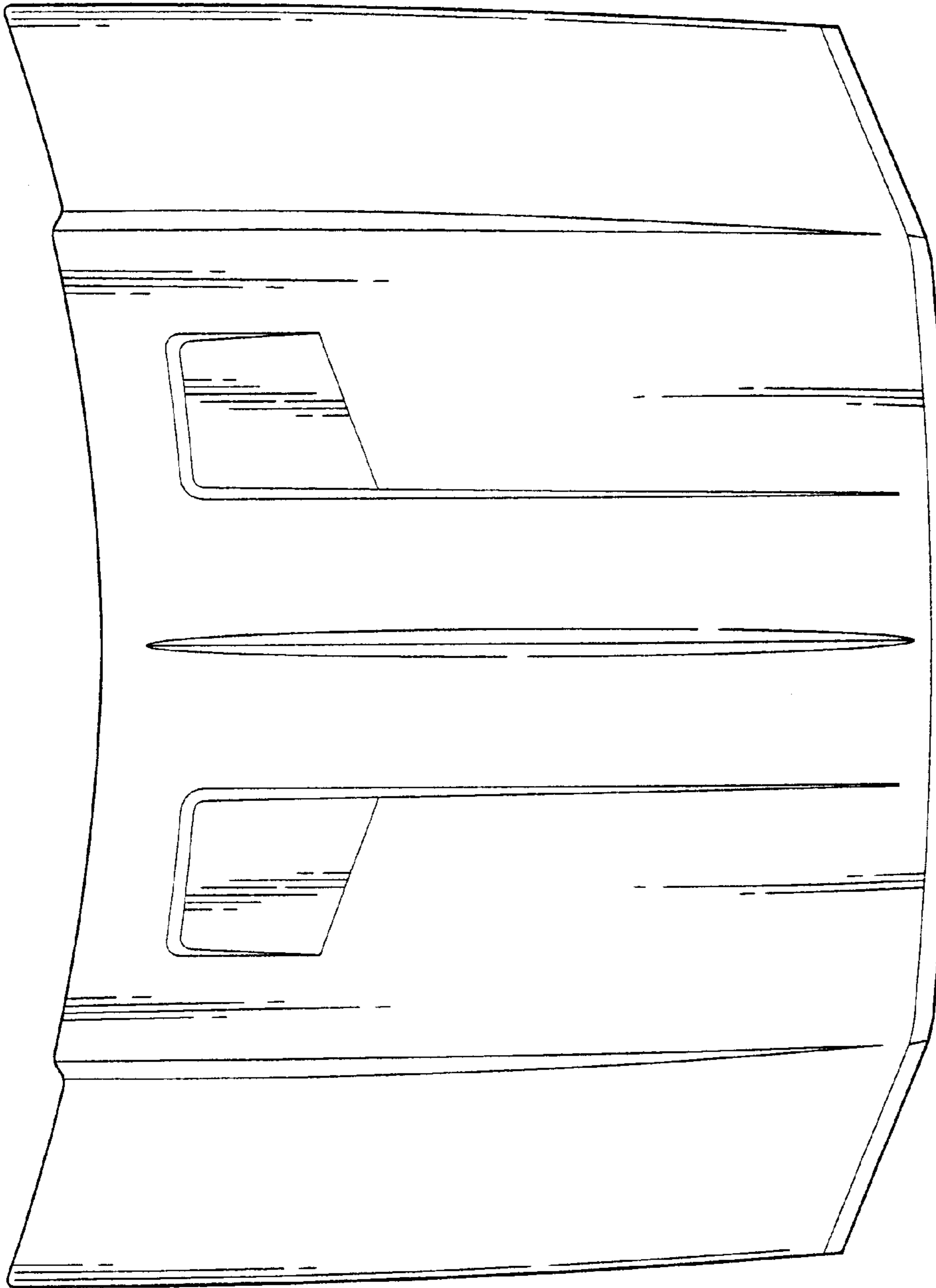

FIG. 6

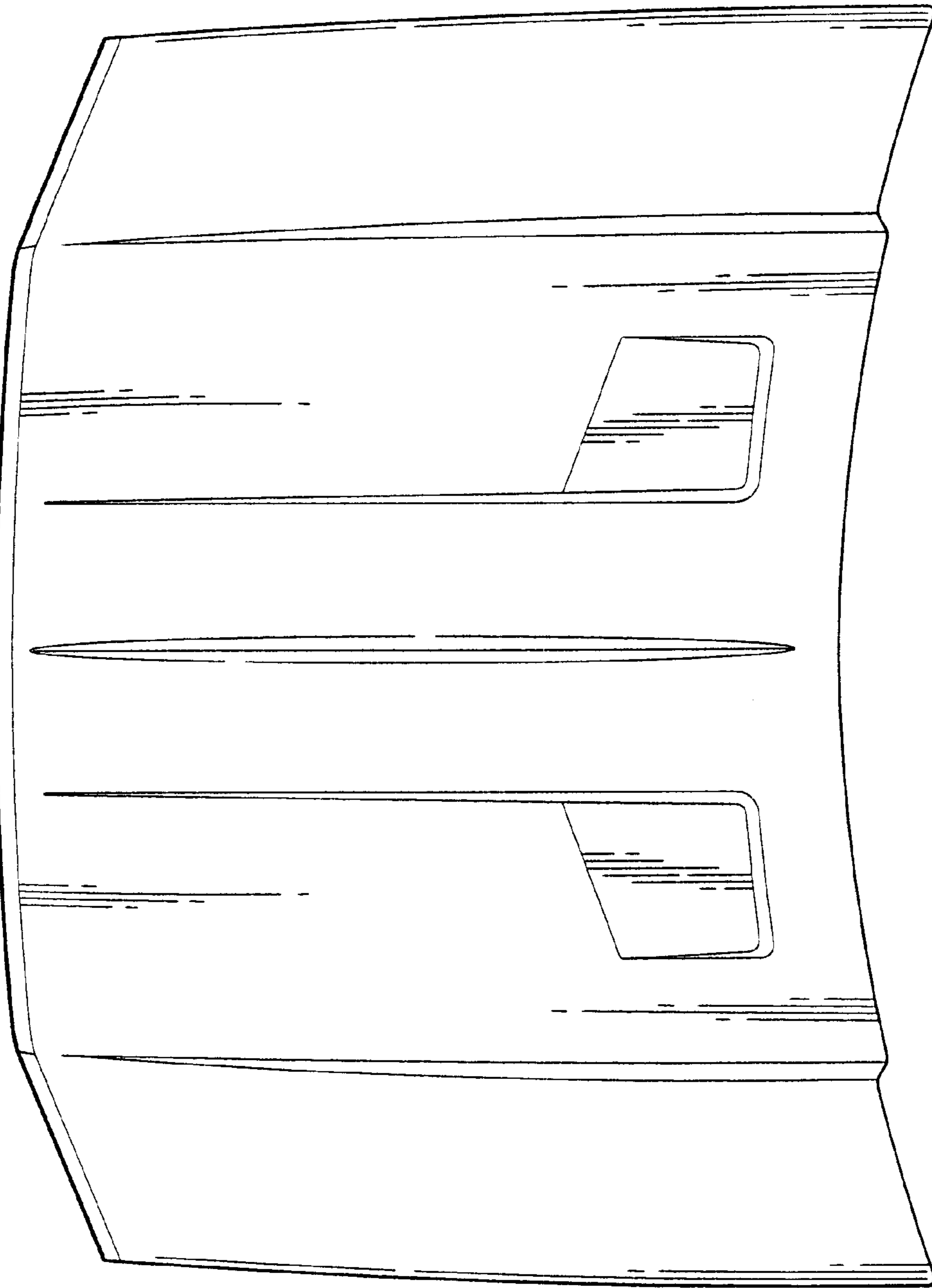

FIG. 7