



US00D477987S

(12) **United States Design Patent**
Adams et al.

(10) **Patent No.:** **US D477,987 S**

(45) **Date of Patent:** **** Aug. 5, 2003**

- (54) **TWO PIECE JAW TYPE CLIP**
- (75) Inventors: **William E. Adams**, Portersville, PA (US); **Matthew H. French**, Slippery Rock, PA (US)
- (73) Assignee: **Adams Mfg. Corp.**, Portersville, PA (US)
- (**) Term: **14 Years**

4,840,341 A	6/1989	Hasegawa	
4,987,659 A	1/1991	Grandis	
5,153,969 A	10/1992	Arrendiell et al.	
5,179,768 A	1/1993	Jio	
5,301,393 A	4/1994	Brown	
D349,312 S	* 8/1994	Whalen	D21/576
5,452,500 A	9/1995	Revis	
6,073,318 A	6/2000	Phillips	
D428,202 S	* 7/2000	Tsai	D28/40
6,393,668 B1	* 5/2002	Olson et al.	24/67.9
D464,685 S	* 10/2002	Weiser et al.	D21/650

(21) Appl. No.: **29/159,716**

(22) Filed: **Apr. 26, 2002**

(51) **LOC (7) Cl.** **08-08**

(52) **U.S. Cl.** **D8/395; D19/65**

(58) **Field of Search** D8/394, 395, 39, D8/40; D19/65, 88; D21/576, 584, 597, 599, 600, 626, 650; 24/67 R, 67.1-67.11, 455, 489, 513, 495, 496, 499, 500-502, 508, 530, 510, 511

(56) **References Cited**

U.S. PATENT DOCUMENTS

353,482 A	* 11/1886	Cottle	24/510
746,844 A	* 12/1903	Jordan	24/510
D137,693 S	* 4/1944	Reinecke	D21/599
D142,161 S	* 8/1945	Braund	D21/597
2,464,739 A	3/1949	Solomon et al.	
3,030,681 A	4/1962	Phillips	
3,597,813 A	8/1971	Takahashi	
3,756,550 A	9/1973	Kollitz	
4,277,864 A	7/1981	Orson, Sr.	
D269,985 S	* 8/1983	Gibbons	D21/600
D271,406 S	* 11/1983	Osborne	D21/650
D286,013 S	10/1986	Adams	

FOREIGN PATENT DOCUMENTS

DE 25 28 005 1/1977

* cited by examiner

Primary Examiner—Louis S. Zarfes

Assistant Examiner—Deanne Levy

(74) *Attorney, Agent, or Firm*—Buchanan Ingersoll, P.C.

(57) **CLAIM**

An ornamental design for a two piece jaw type clip, as shown and described.

DESCRIPTION

FIG. 1 is a perspective view of our two piece jaw type clip; FIG. 2 is a top plan view thereof; FIG. 3 is a rear view thereof; FIG. 4 is a right side view, the left side being a mirror image thereof; FIG. 5 is a bottom view thereof; and, FIG. 6 is a front view thereof. A magnet is shown in dotted line for illustrative purposes and forms no part of the present design.

1 Claim, 3 Drawing Sheets

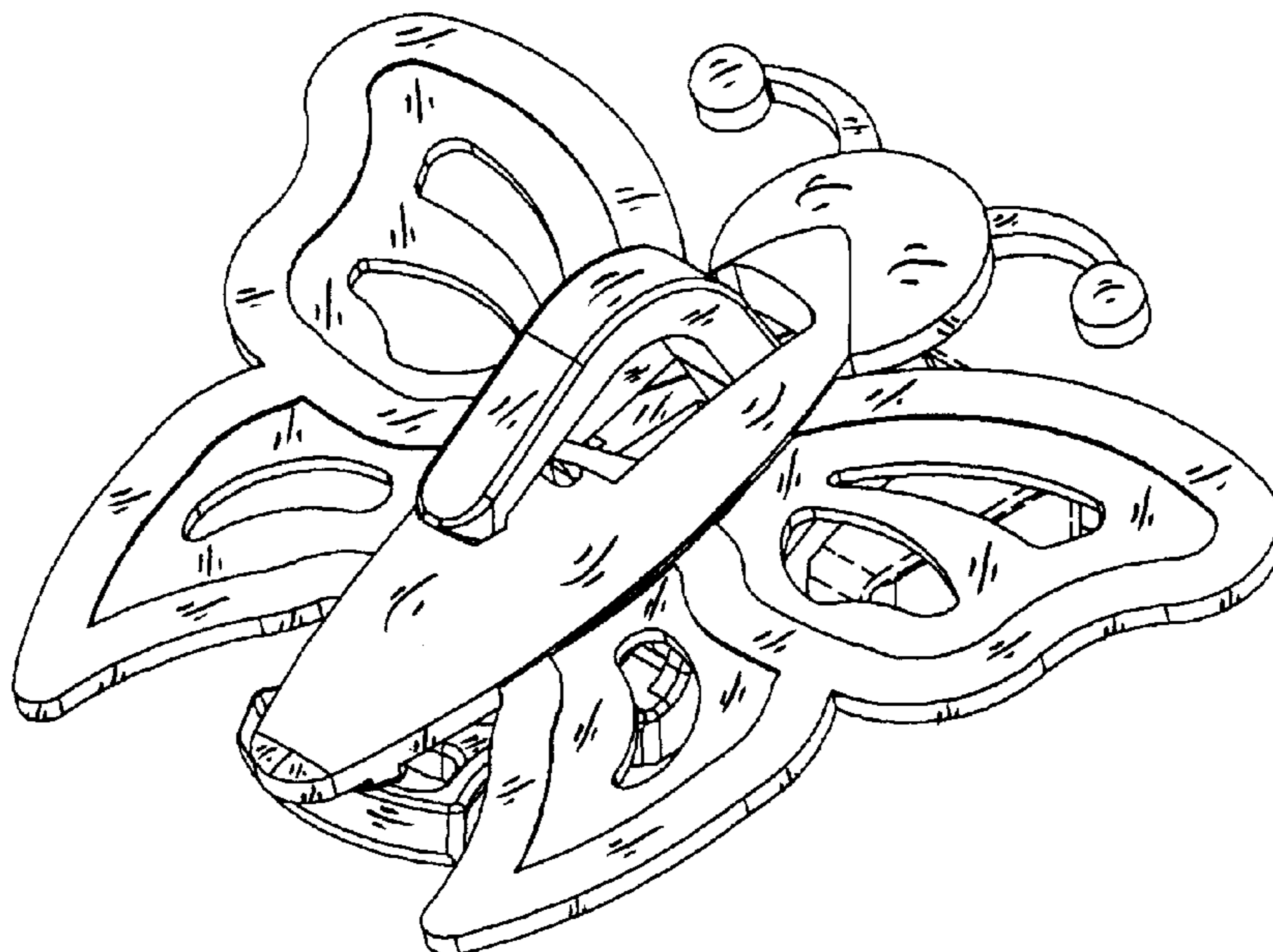

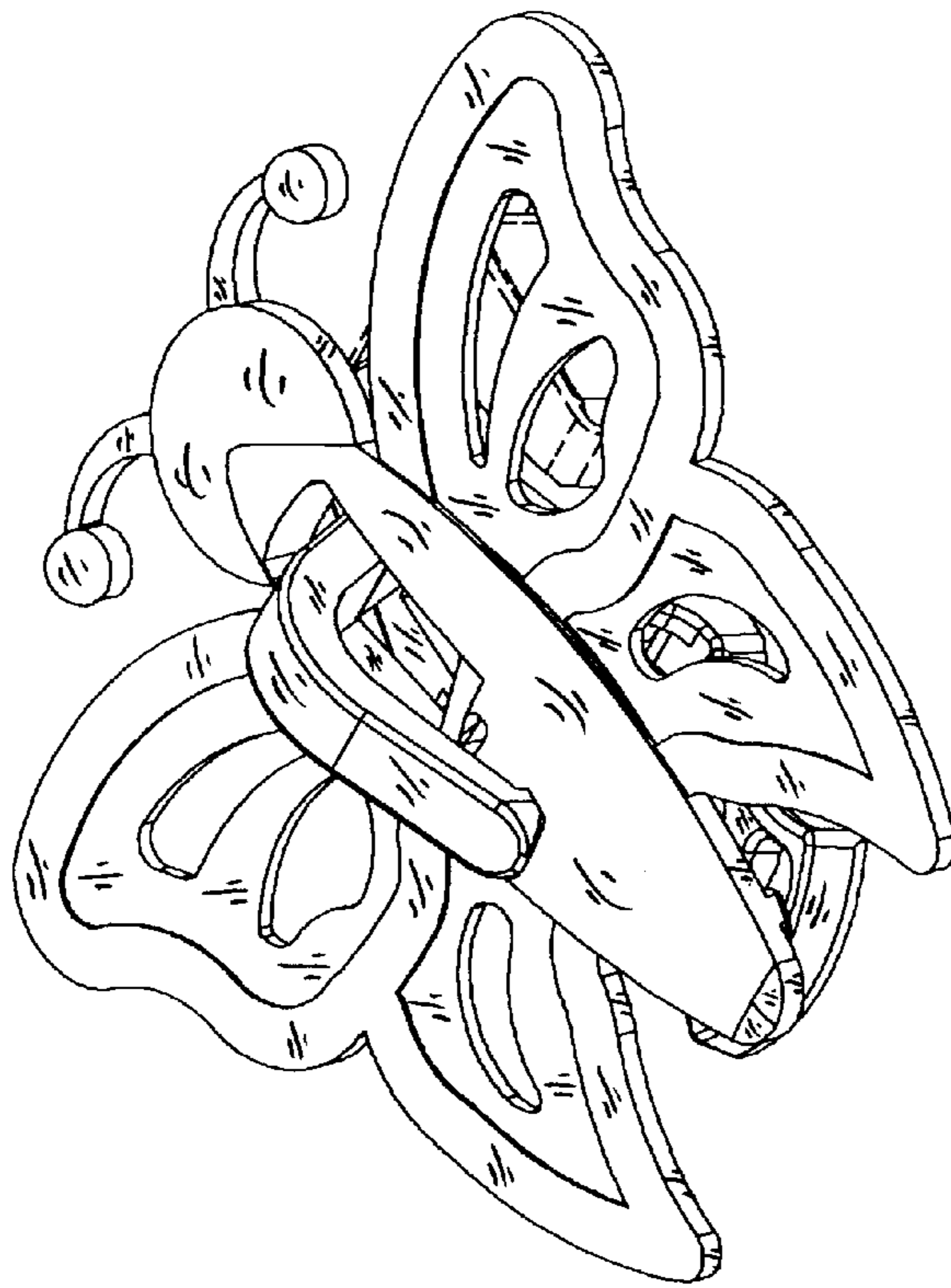

FIG. 1

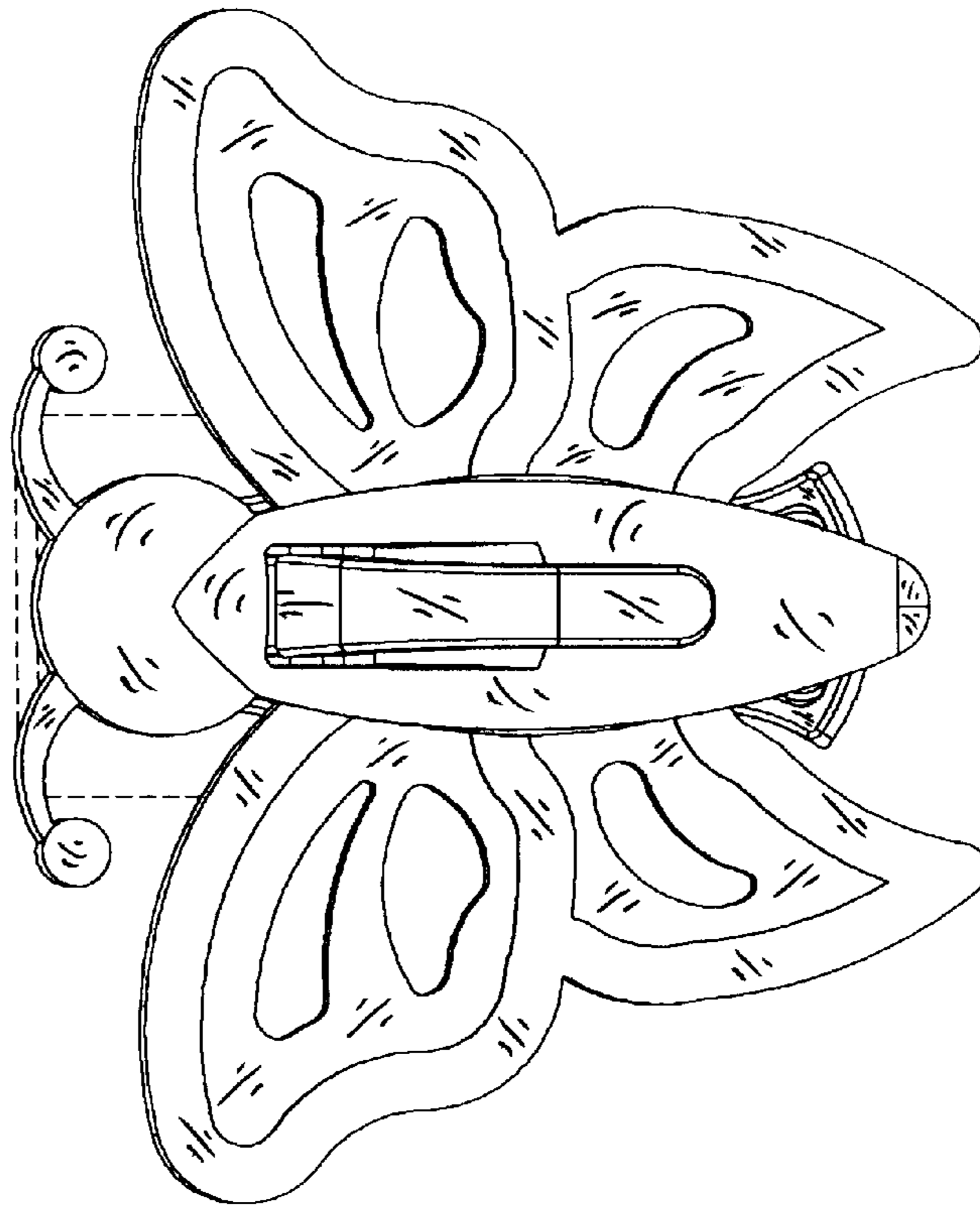

FIG. 2

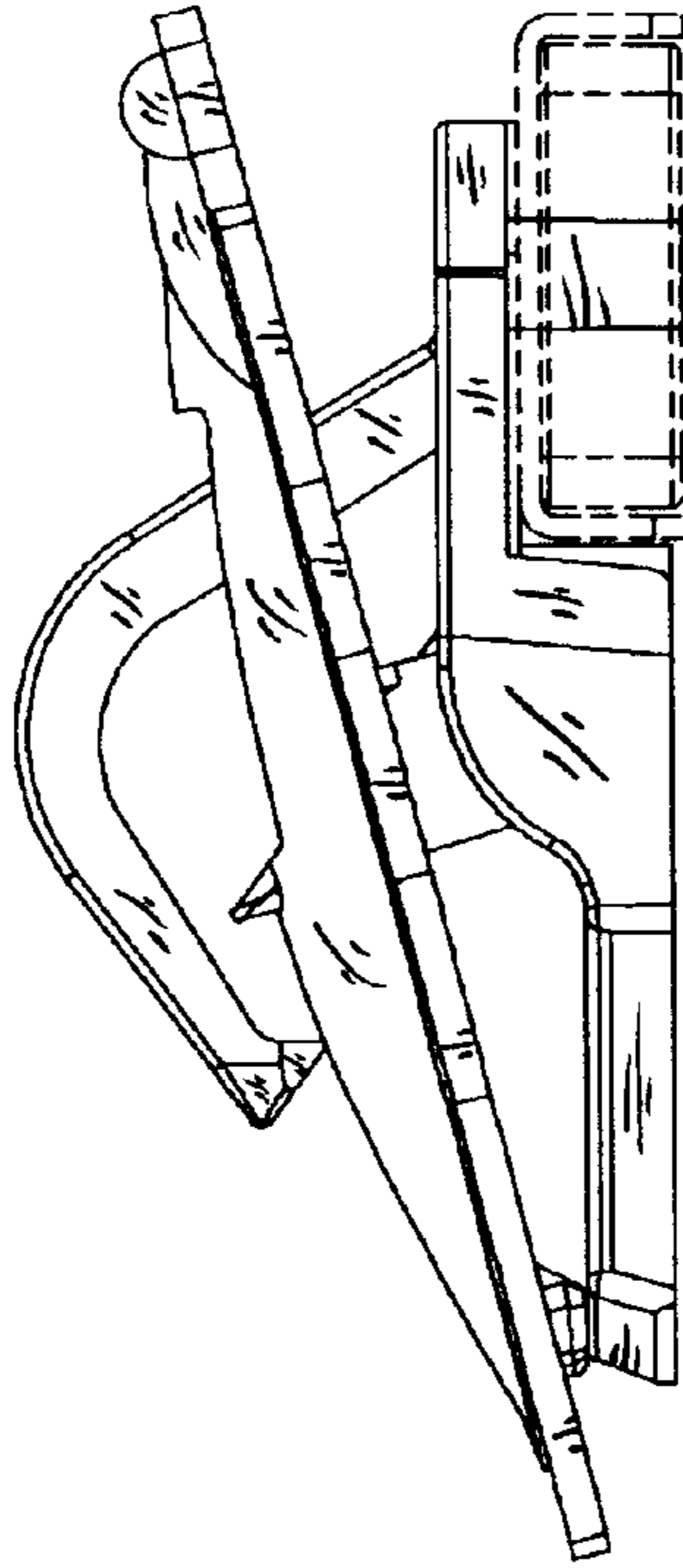

FIG. 4

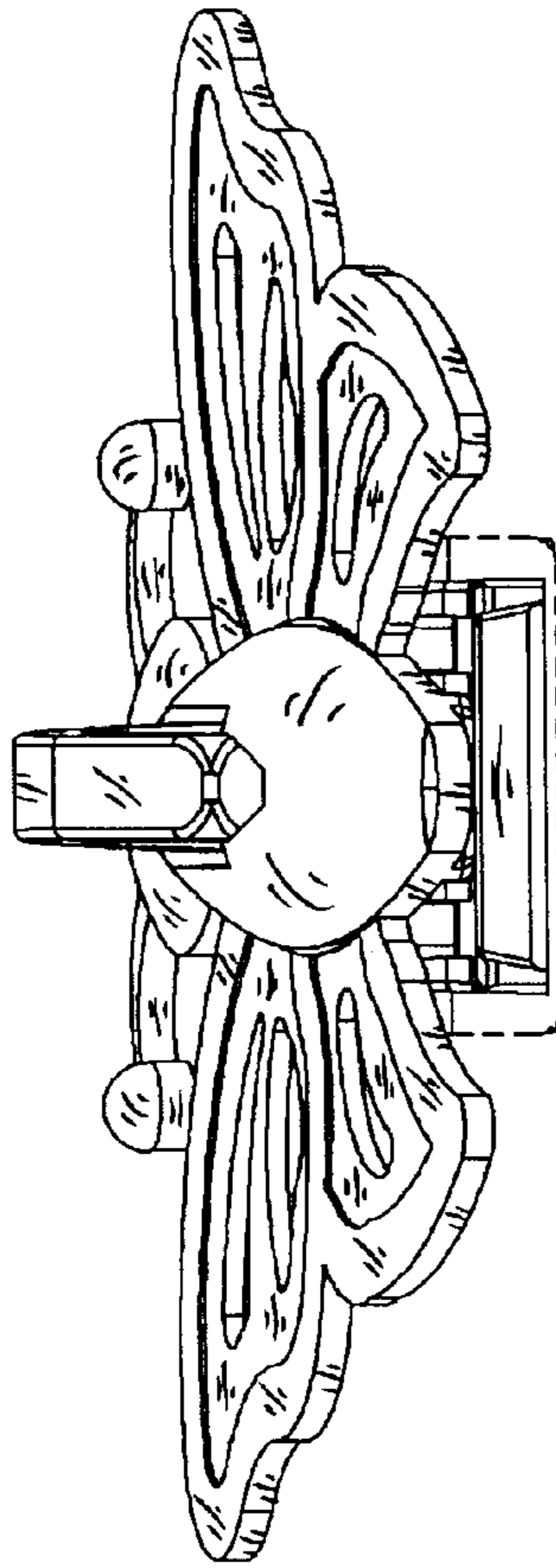

FIG. 3

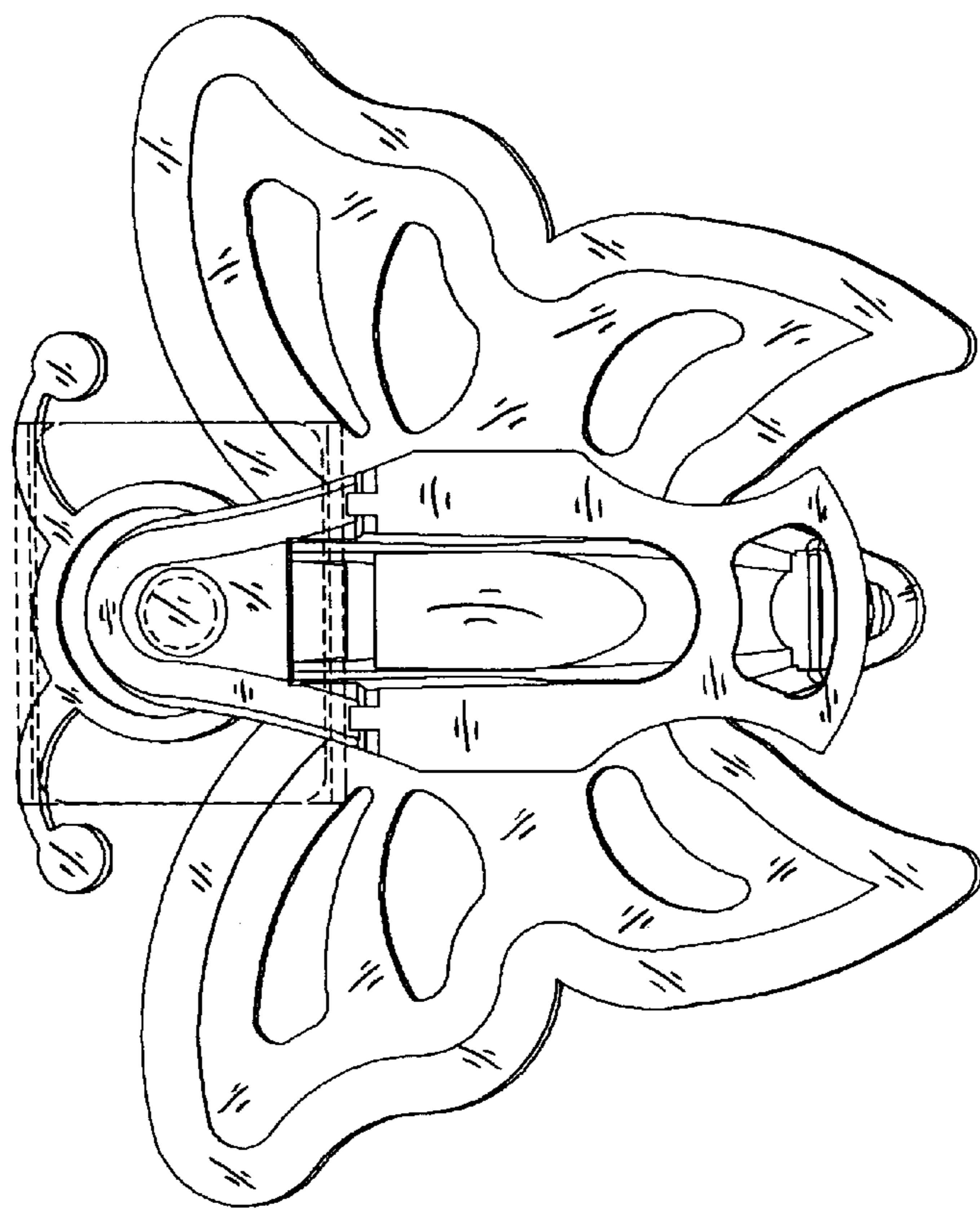

FIG. 5

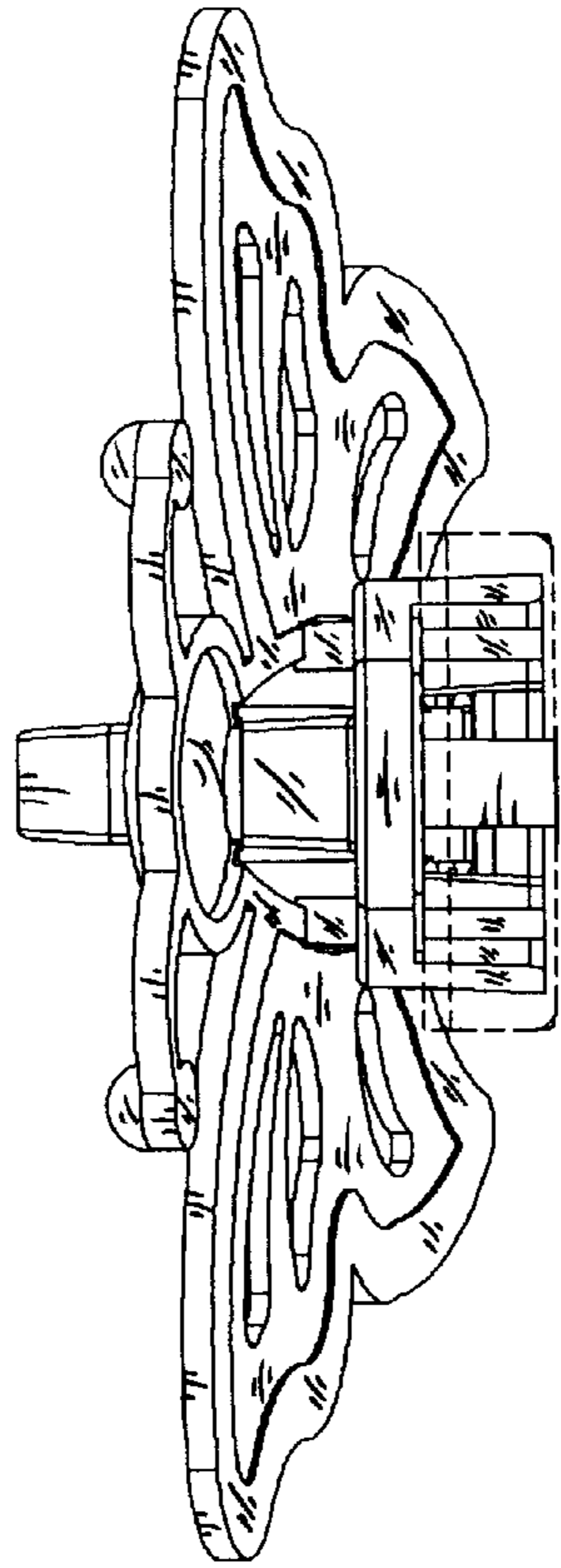

FIG. 6