



US00D477981S

(12) **United States Design Patent**
Snider

(10) **Patent No.:** **US D477,981 S**

(45) **Date of Patent:** **** Aug. 5, 2003**

- (54) **HACKSAW**
- (75) Inventor: **Gregory Scott Snider**, Bel Air, MD (US)
- (73) Assignee: **Black & Decker Inc.**, Newark, DE (US)
- (**) Term: **14 Years**
- (21) Appl. No.: **29/159,321**
- (22) Filed: **Apr. 18, 2002**
- (51) **LOC (7) Cl.** **08-03**
- (52) **U.S. Cl.** **D8/96; D8/97**
- (58) **Field of Search** D8/95, 96, 97, D8/98, 99, 107; 30/506, 507, 511, 513, 514, 515, 516, 517

D409,892 S	5/1999	Juhlin	D8/96
6,070,330 A	6/2000	Phelon et al.	30/513
6,079,109 A	6/2000	Ranieri	30/513
D428,321 S	* 7/2000	Ranieri et al.	D8/96
6,134,791 A	10/2000	Huang	30/513
6,266,887 B1	7/2001	Owens et al.	30/513

FOREIGN PATENT DOCUMENTS

FR 2 293 277 12/1974

* cited by examiner

Primary Examiner—Philips S. Hyder

(74) *Attorney, Agent, or Firm*—Harness, Dickey & Pierce, P.L.C.

(57) **CLAIM**

The ornamental design for a hacksaw, as shown and described.

DESCRIPTION

FIG. 1 is a left side elevational view showing my new design;
 FIG. 2 is a rear elevational view of the hacksaw of FIG. 1;
 FIG. 3 is a right side elevational view of the hacksaw of FIG. 1;
 FIG. 4 is a front elevational view of the hacksaw of FIG. 1;
 FIG. 5 is a top plan view of the hacksaw of FIG. 1;
 FIG. 6 is a bottom plan view of the hacksaw of FIG. 1;
 FIG. 7 is a left side elevational view of a portion of the hacksaw of FIG. 1 illustrating the front pillar in greater detail; and,
 FIG. 8 is another left side elevational view of the hacksaw of FIG. 1.

The broken lines showing a hacksaw blade in FIGS. 1, 3, 7 and 8, the hole for receiving a screw to retain the front pillar of the hacksaw to the hacksaw frame in FIGS. 1, 4, 7 and 8 and the end cap plugs in FIG. 8 are environmental only and form no part of the claimed design.

1 Claim, 3 Drawing Sheets

- (56) **References Cited**
- U.S. PATENT DOCUMENTS**
- 1,713,972 A 5/1929 Lufkin
- 1,840,925 A 1/1932 Welch
- 2,399,869 A 5/1946 Hough
- 3,327,748 A 6/1967 Reuterfors 30/513
- 3,602,278 A 8/1971 Brucken
- 3,727,655 A 4/1973 Garcher
- 3,822,731 A 7/1974 Keymer 30/513
- 3,848,649 A 11/1974 Wanless
- D245,754 S 9/1977 Breger D8/96
- 4,367,779 A 1/1983 Ewig 30/506
- 4,466,471 A 8/1984 Thomson 30/517
- 4,592,145 A 6/1986 Egan et al. 30/507
- D318,006 S 7/1991 Wanner et al. D8/96
- 5,074,002 A 12/1991 Huang 7/149
- 5,388,333 A * 2/1995 Chen 30/508
- D370,610 S 6/1996 Neyton D8/96
- 5,673,488 A 10/1997 Grayo 30/513
- 5,722,173 A * 3/1998 Huang 30/510
- 5,768,788 A 6/1998 Arnold 30/513
- 5,826,344 A 10/1998 Phelon et al. 30/513

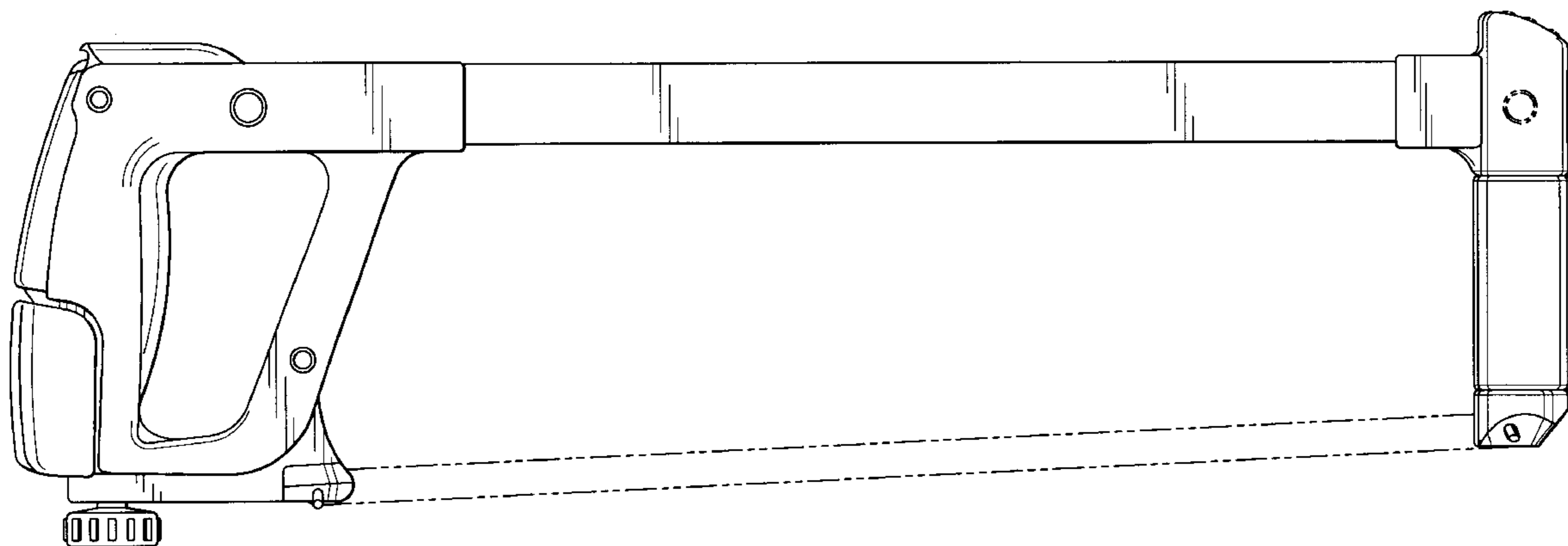

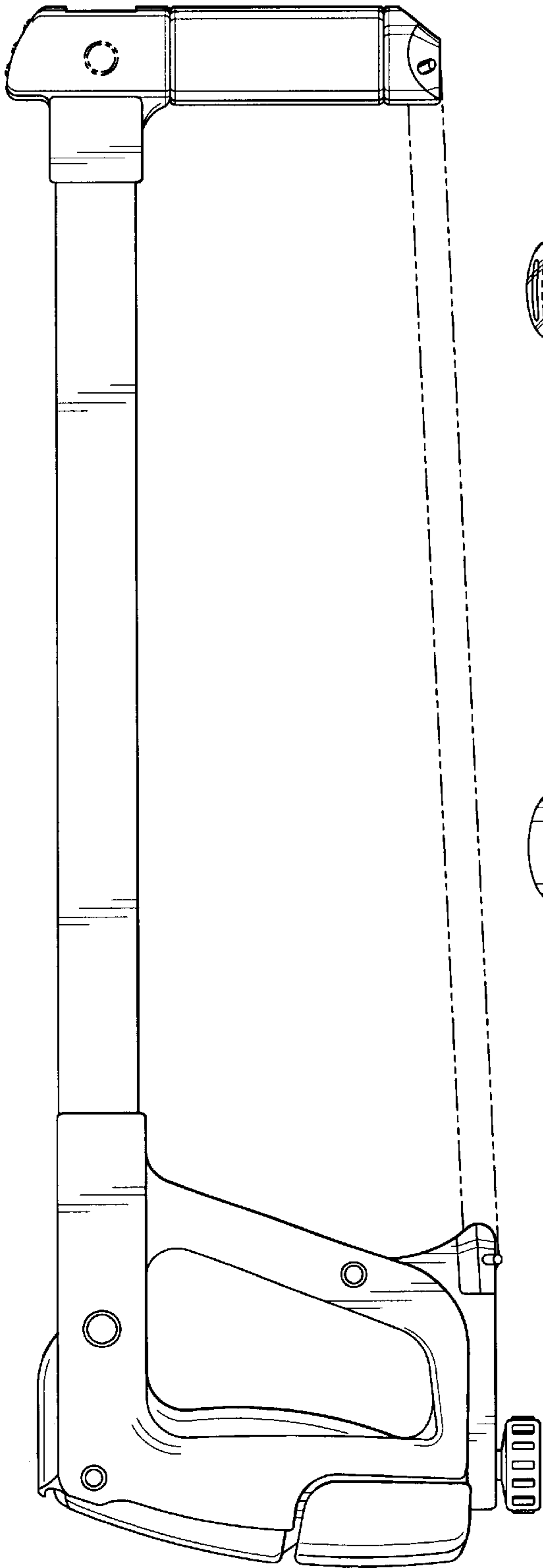

Fig-1

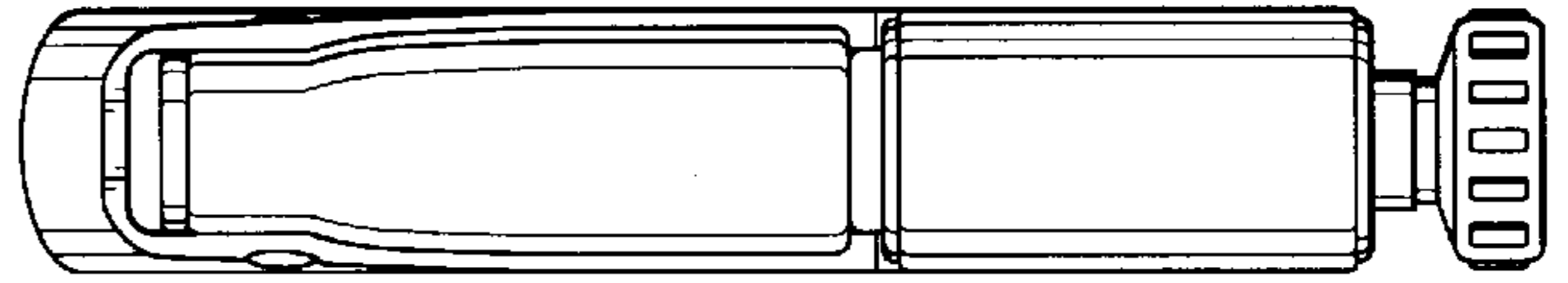

Fig-2

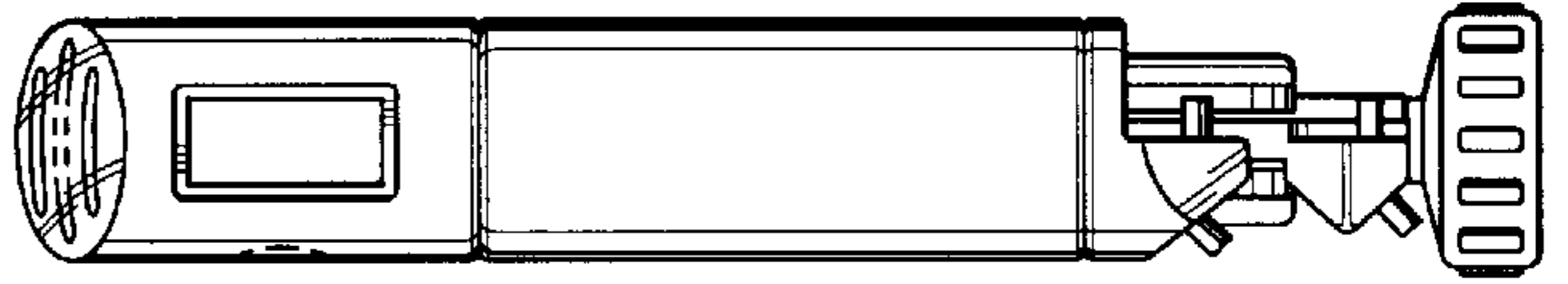

Fig-4

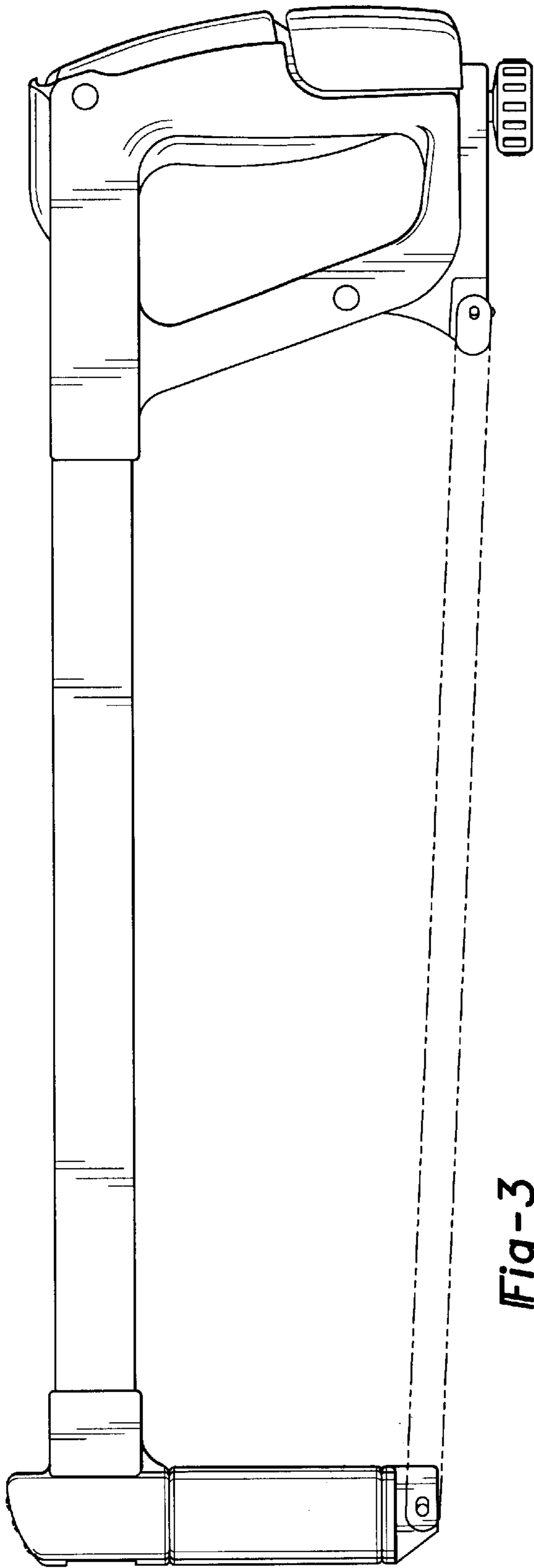

Fig-3

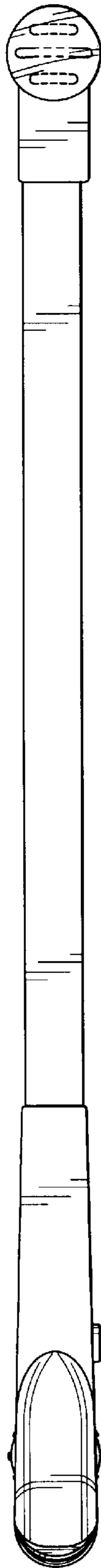

Fig-5

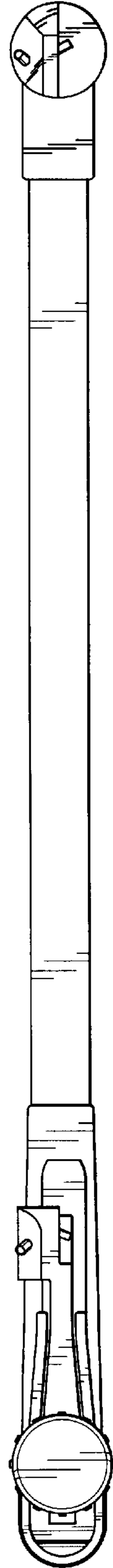

Fig-6

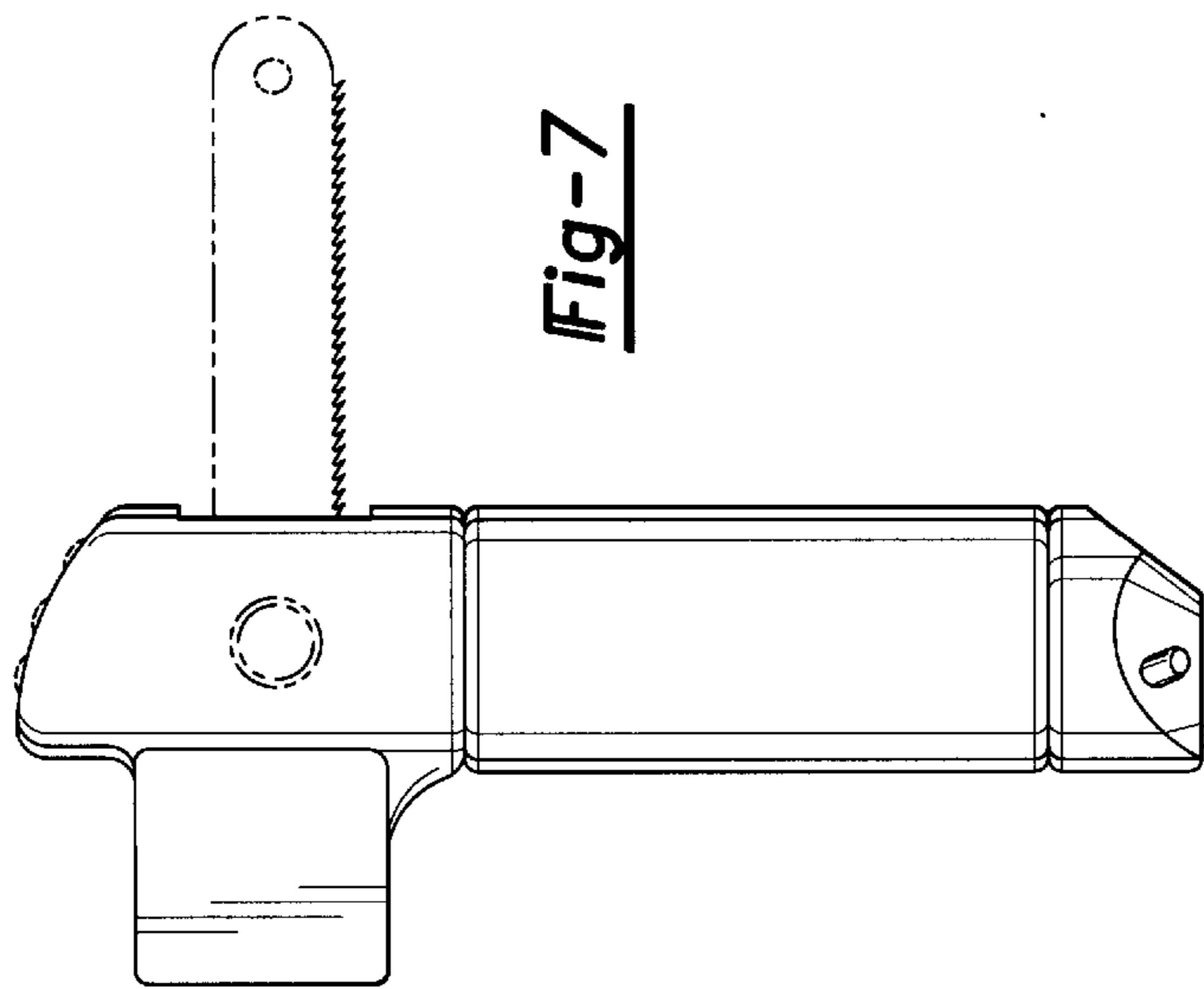

Fig-7

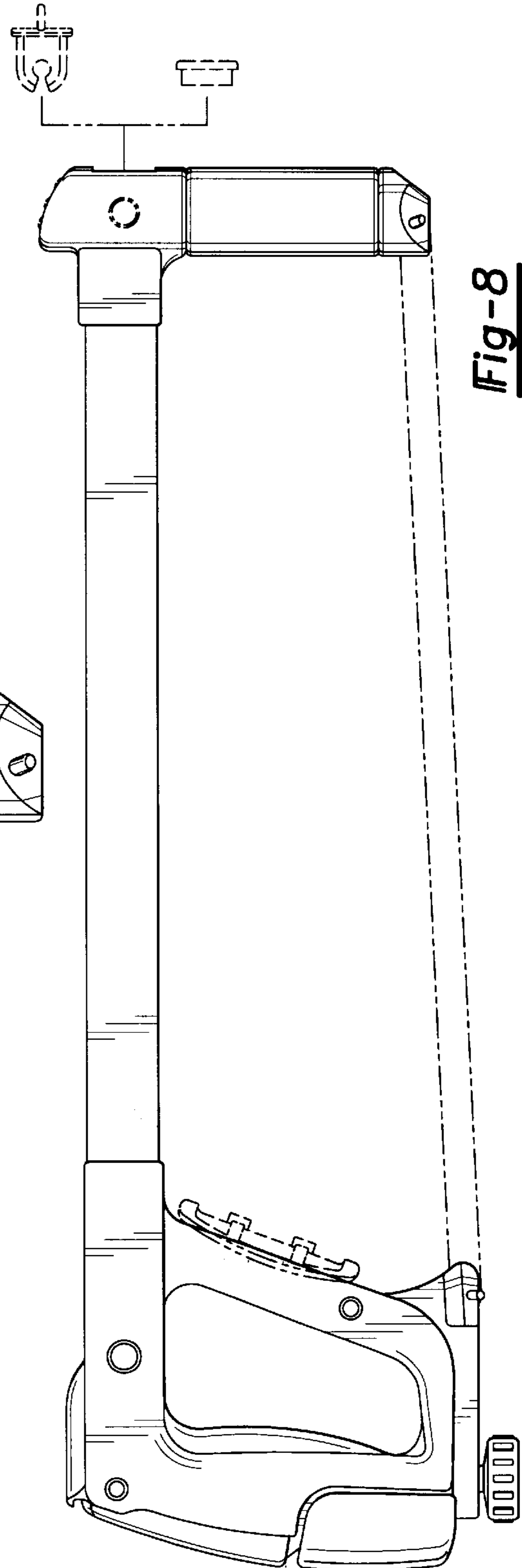

Fig-8