



US00D477968S

(12) **United States Design Patent**
Bin

(10) **Patent No.:** **US D477,968 S**

(45) **Date of Patent:** **** Aug. 5, 2003**

(54) **BOTTOM FLARING RIBBED-BASE MUG**

(76) **Inventor:** **Jin Xue Bin**, House 337, Bi Lai Yuan,
Morning Star Villa, Gangkou Town,
Zhongshan (CN)

(**) **Term:** **14 Years**

(21) **Appl. No.:** **29/164,567**

(22) **Filed:** **Jul. 26, 2002**

(51) **LOC (7) Cl.** **07-01**

(52) **U.S. Cl.** **D7/510; D7/511**

(58) **Field of Search** D7/510, 511, 509;
220/705, 714, 603, 254.5, 715, 719, 592.16,
592.17; 222/129; 206/217, 541

(56) **References Cited**

U.S. PATENT DOCUMENTS

4,130,215	A	*	12/1978	Corey et al.	220/719
D354,200	S	*	1/1995	Grappolini	D7/538
D363,414	S	*	10/1995	Goto et al.	D7/533
5,454,482	A	*	10/1995	Simon	220/713
D366,186	S	*	1/1996	Kato	D7/536
5,542,670	A	*	8/1996	Morano	220/713
D375,655	S	*	11/1996	King	D7/511
D382,174	S	*	8/1997	Grimm	D7/510
D406,725	S	*	3/1999	Joergensen	D7/400

D411,713	S	*	6/1999	Bridges	D7/536
D417,365	S	*	12/1999	Huang	D7/511
D418,013	S	*	12/1999	Fujii	D7/510
D436,294	S	*	1/2001	Marck	D7/511
D442,736	S	*	5/2001	McGilvray	D27/118
D456,212	S	*	4/2002	Bridges	D7/510
D457,395	S	*	5/2002	Gluck	D7/510
D462,876	S	*	9/2002	Janky et al.	D7/536
D465,132	S	*	11/2002	Janky et al.	D7/510

* cited by examiner

Primary Examiner—M. N. Pandozzi

(57) **CLAIM**

The ornamental design for “bottom flaring ribbed-base mug”, is substantially as shown and described.

DESCRIPTION

FIG. 1 is a view from the upper and left perspective of “bottom flaring ribbed-base mug” showing my new design; FIG. 2 is a top view thereof. FIG. 3 is a bottom view thereof. FIG. 4 is a left side view in elevation thereof. FIG. 5 is a right side view in elevation thereof. FIG. 6 is a front side view in elevation thereof; and, FIG. 7 is a rear view in elevation thereof.

1 Claim, 2 Drawing Sheets

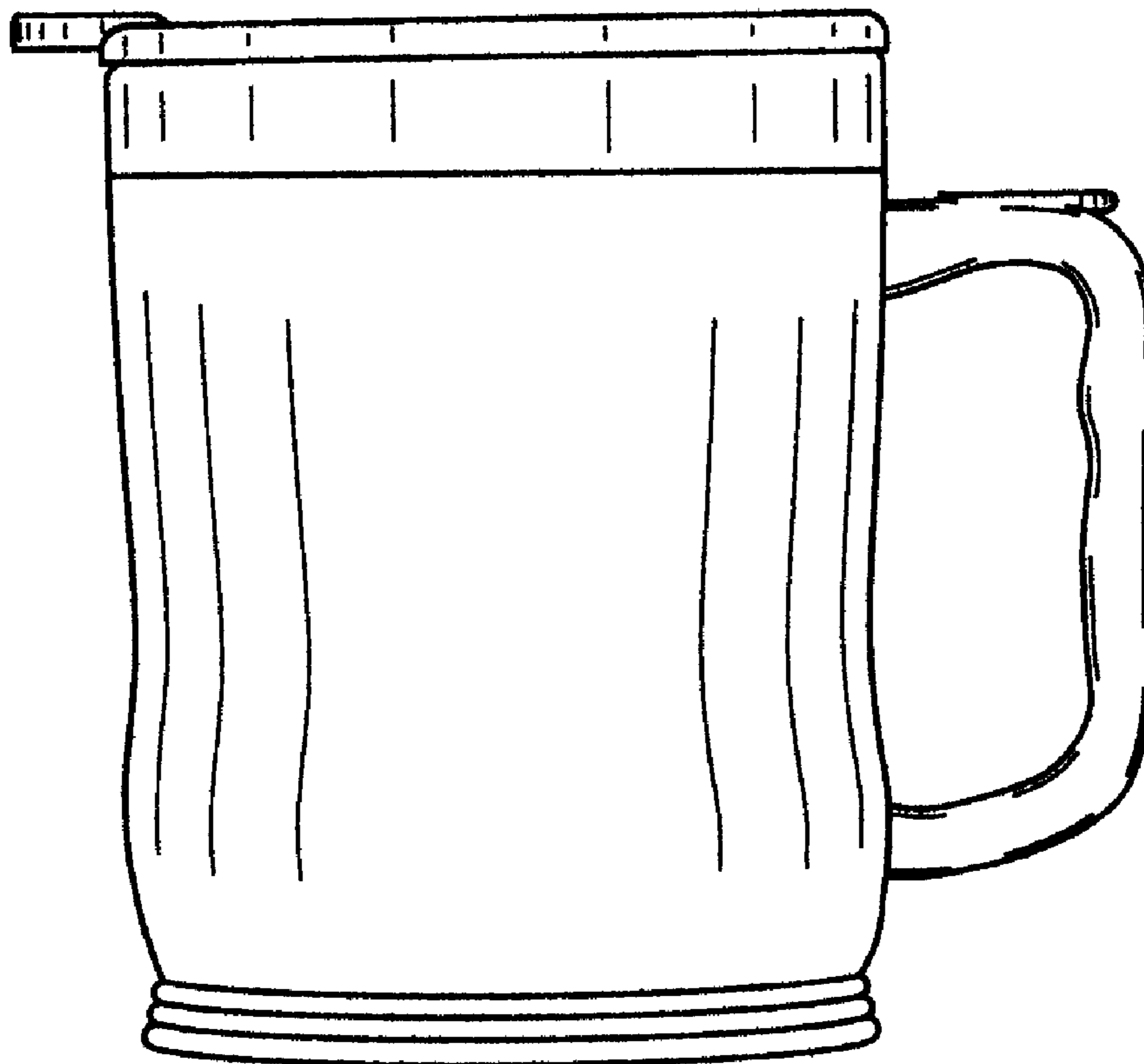



Fig.1

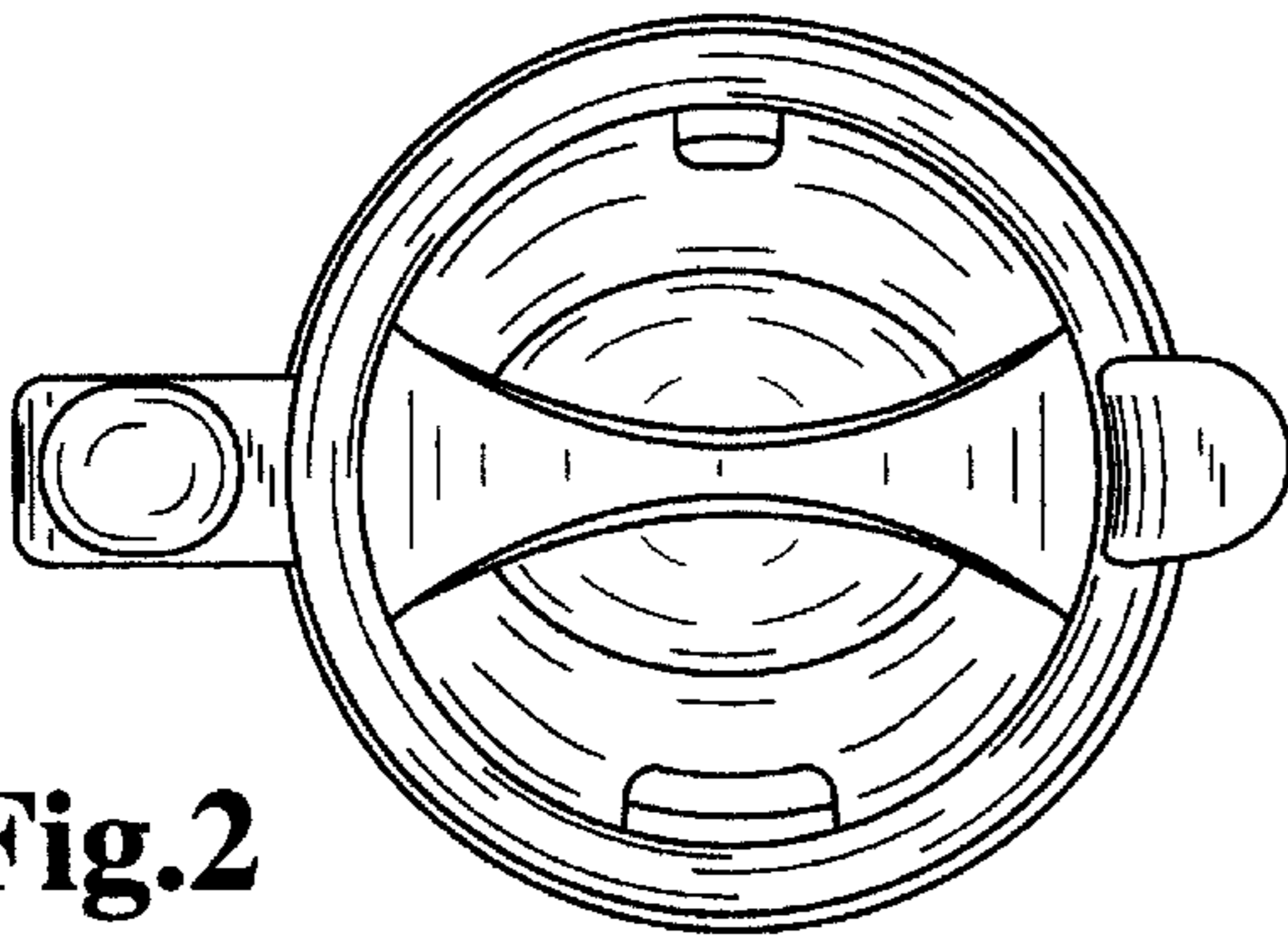

Fig.2

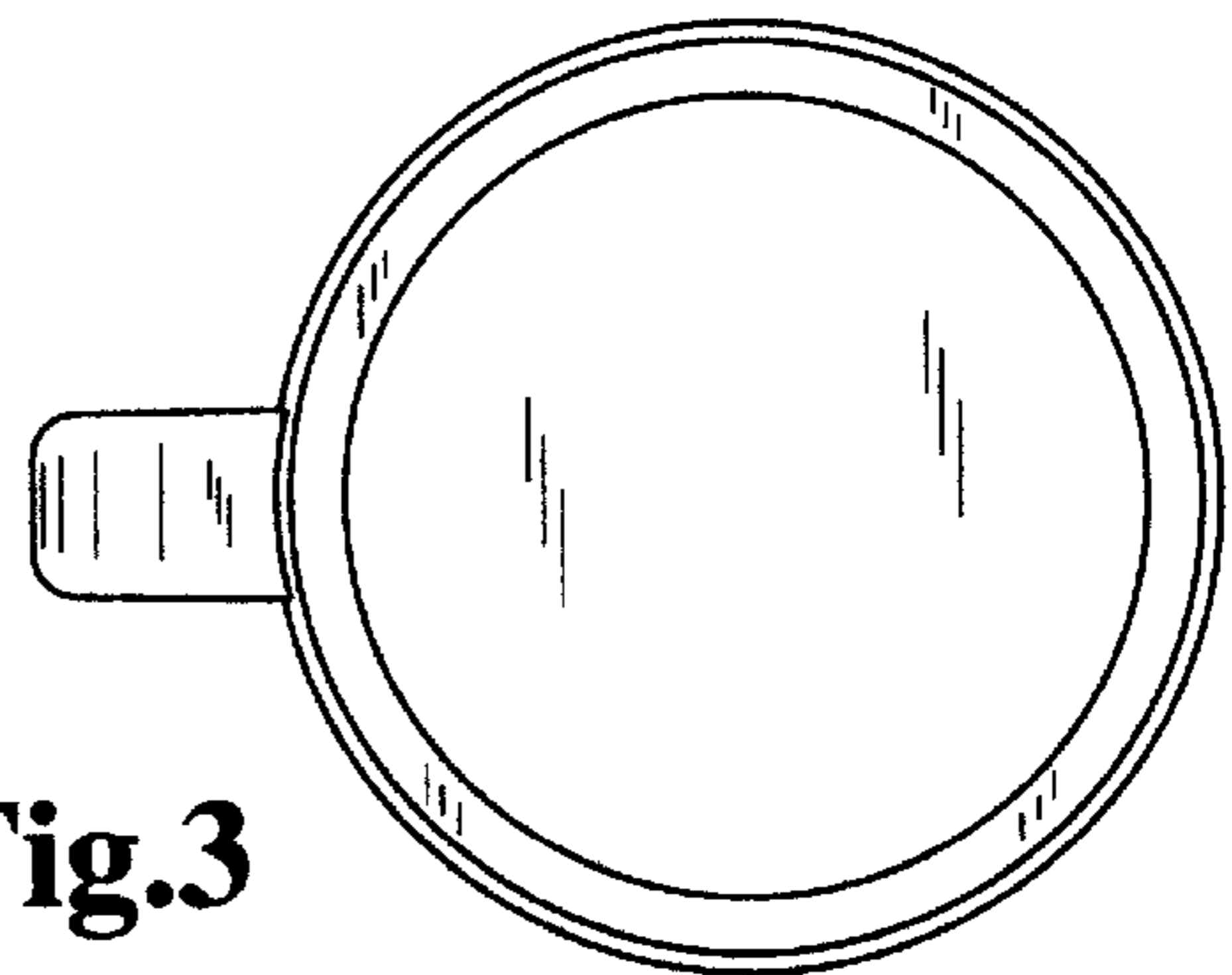

Fig.3

Fig.4

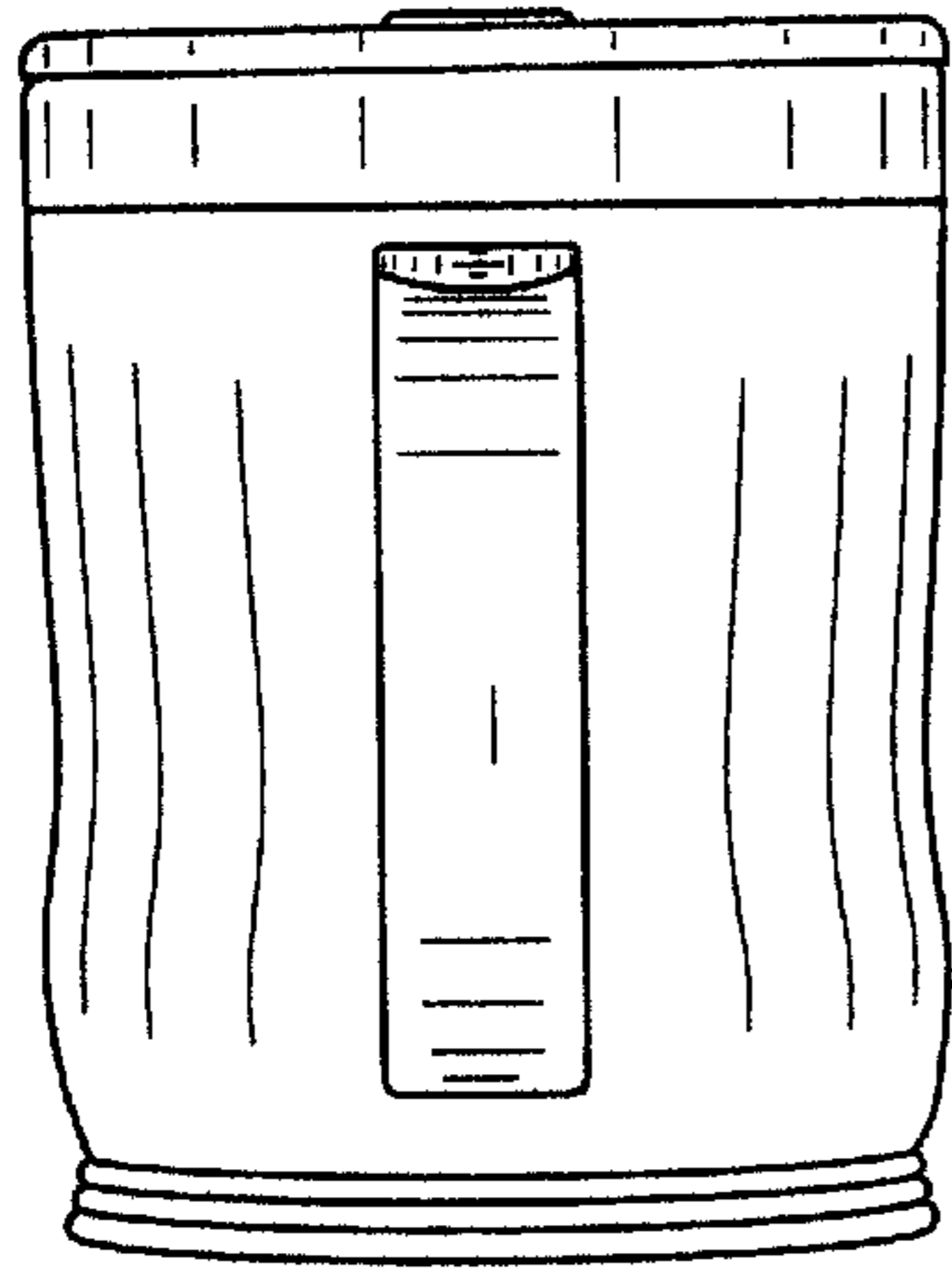

Fig.5

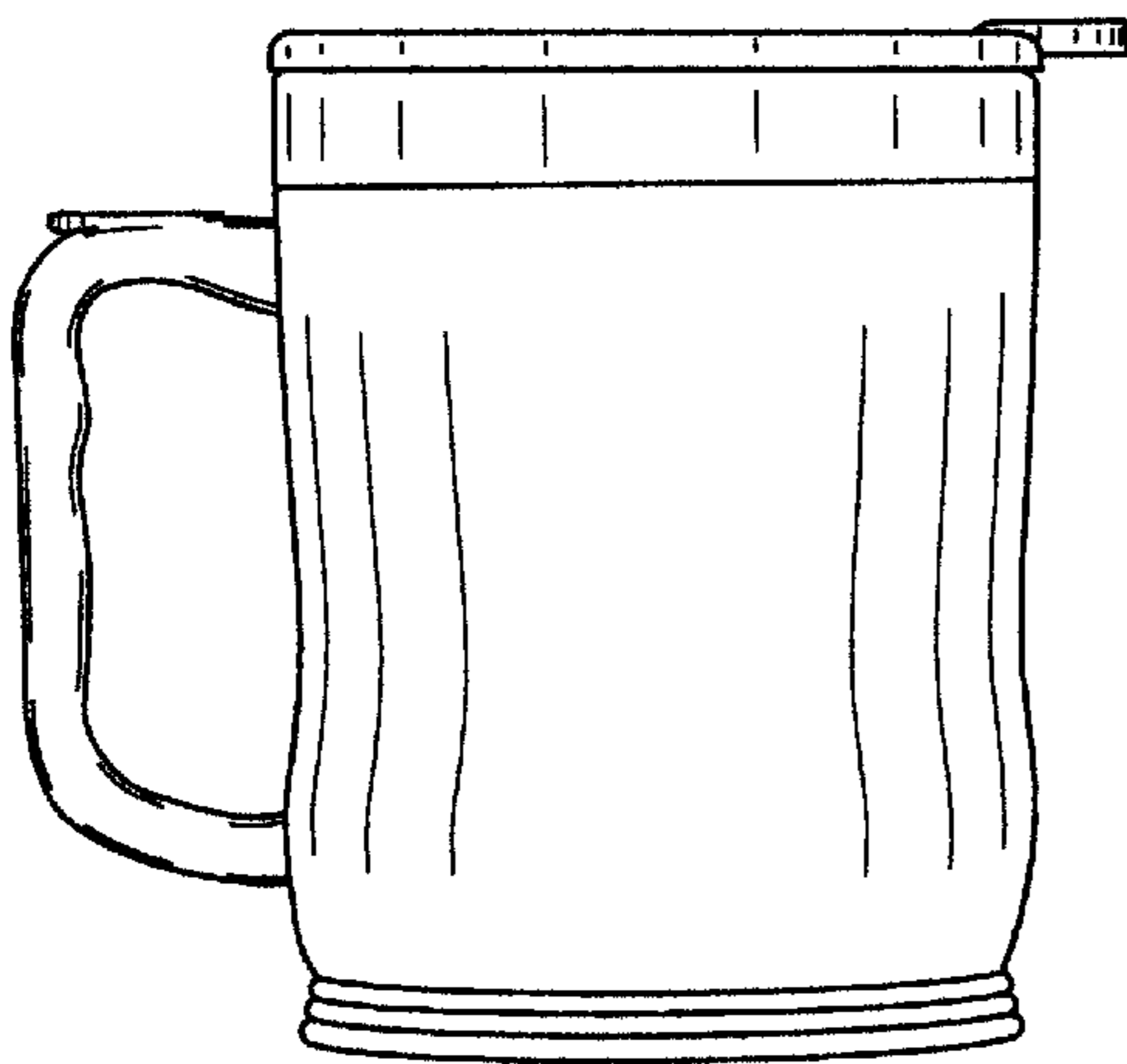
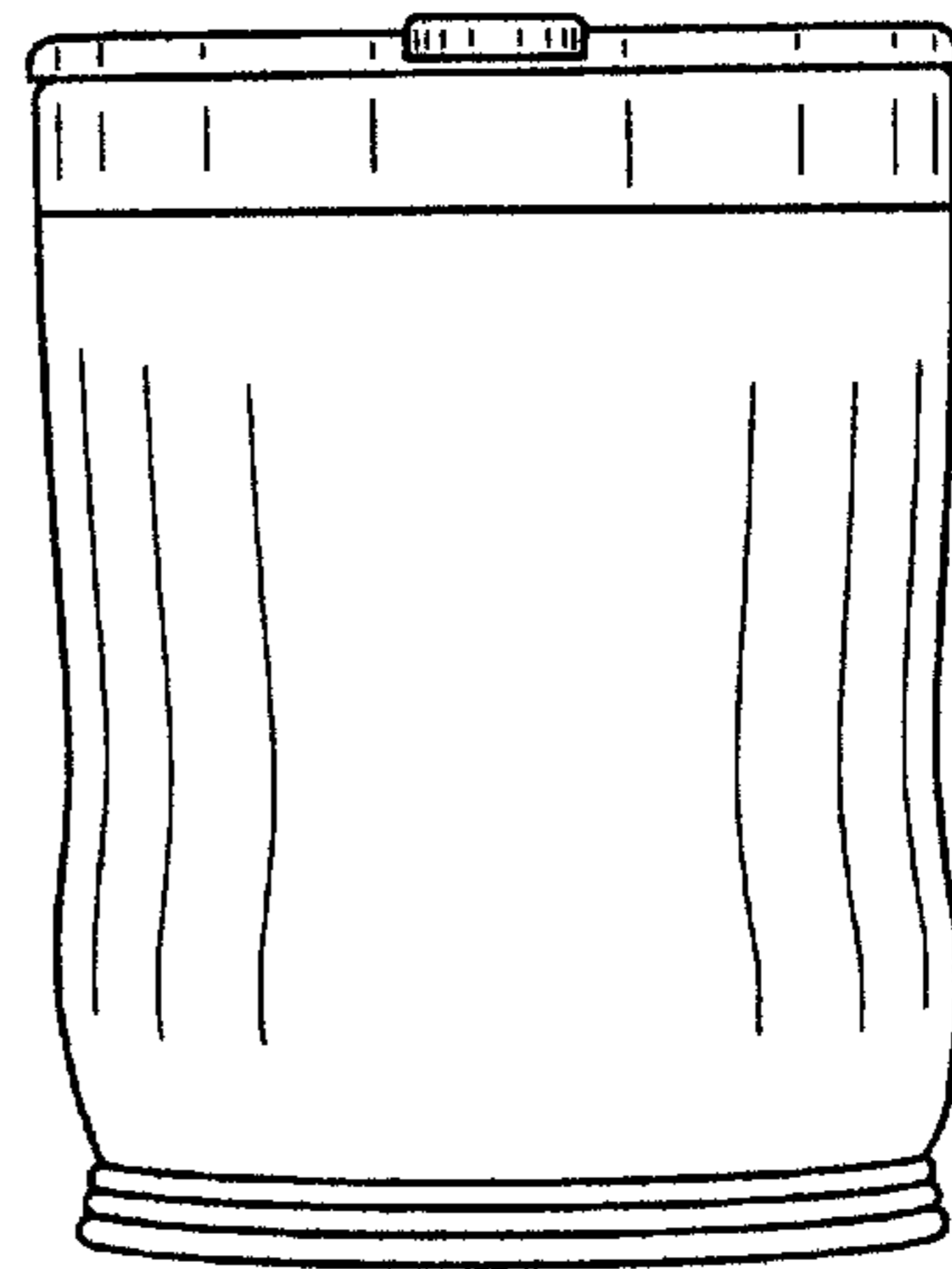

Fig.6

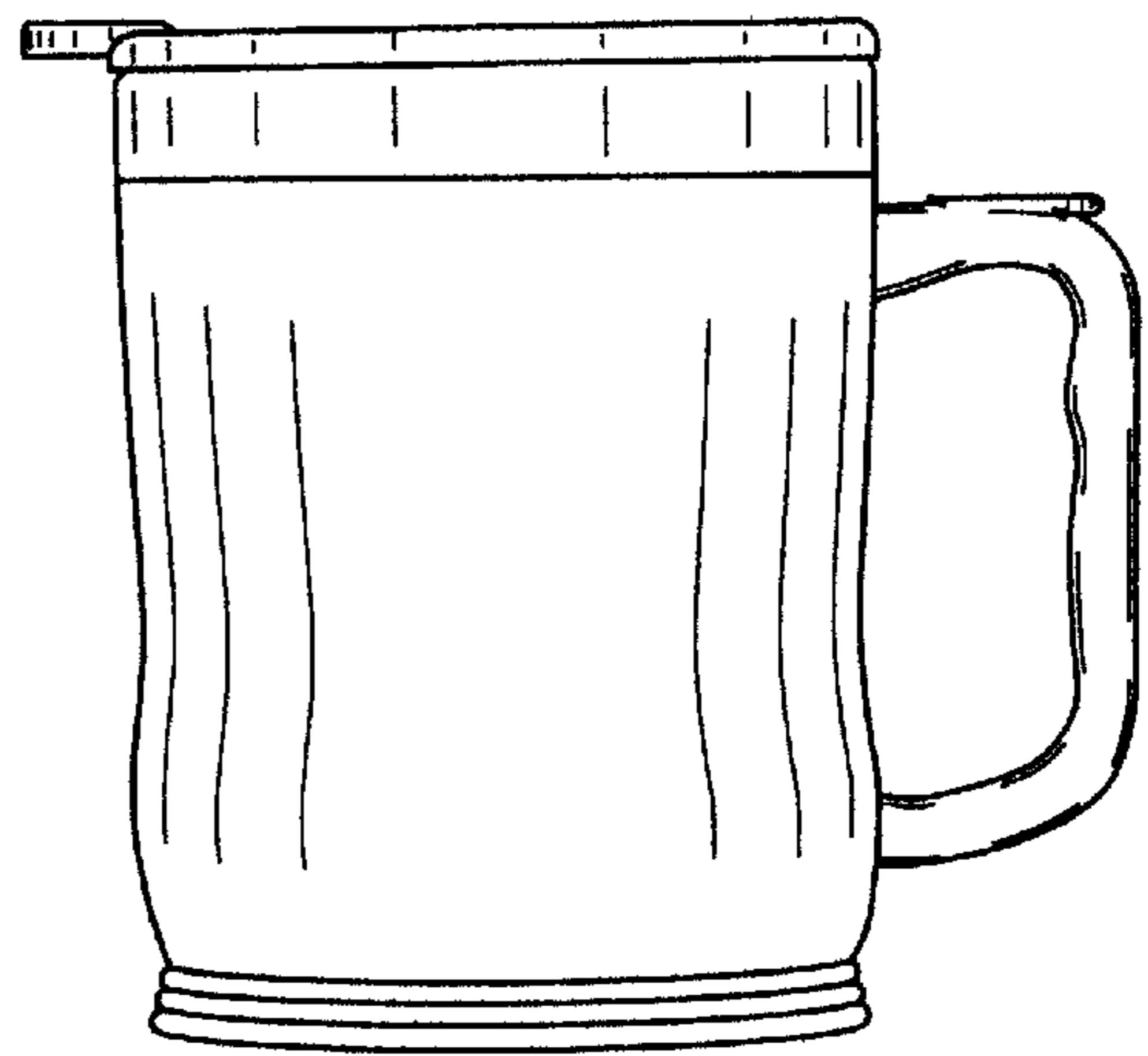

Fig.7