



US00D477923S

(12) **United States Design Patent**
Lindaman

(10) **Patent No.:** **US D477,923 S**

(45) **Date of Patent:** **** Aug. 5, 2003**

(54) **WEBBED HUNTER'S SEAT WITH FOLDING LEGS**

(76) Inventor: **Glenn Lindaman**, 10 Madison La.,
Whitehall, PA (US) 18052

(**) Term: **14 Years**

(21) Appl. No.: **29/172,920**

(22) Filed: **Dec. 18, 2002**

(51) **LOC (7) Cl.** **06-01**

(52) **U.S. Cl.** **D6/353**

(58) **Field of Search** D6/334, 335, 336,
D6/349-353, 355, 367, 368, 369, 500-502;
297/4, 17, 461, 462, 423.1, 423.4, 423.14,
423.15, 423.16, 423.39, 423.41, 452.63

(56) **References Cited**

U.S. PATENT DOCUMENTS

D87,229 S	*	6/1932	McGowen	D6/349
2,727,564 A	*	12/1955	Gruber	D6/368
3,994,529 A	*	11/1976	Lippert	D6/368
D284,047 S	*	6/1986	Striebel	D6/353
D299,388 S	*	1/1989	Frinier	D6/349
D317,532 S	*	6/1991	Meadows	D6/355
D454,437 S	*	3/2002	Minneman et al.	D6/349
D467,440 S	*	12/2002	Lindman et al.	D6/349

* cited by examiner

Primary Examiner—Stacia Cadmus

Assistant Examiner—Mimosa De

(74) *Attorney, Agent, or Firm*—Duane Morris LLP

(57) **CLAIM**

The ornamental design of a webbed hunter's seat with folding legs, as shown and described.

DESCRIPTION

FIG. 1 is a perspective view of a webbed hunter's seat with folding legs, according to the new design, shown with the legs unfolded, and shaded to show flat, smooth surfaces; FIG. 2 is a top plan view thereof; FIG. 3 is a bottom plan view thereof, a carrying strap being shortened and wrapped on the frame of the seat for storage; FIG. 4 is a side elevation, from the left side in FIG. 1; FIG. 5 is a side elevation as in FIG. 4, but from the right side in FIG. 1; FIG. 6 is a front elevation view; FIG. 7 is a rear elevation view; FIG. 8 is perspective view showing the carrying strap in position for carrying and the legs folded; and, FIG. 9 is a bottom plan view showing the legs folded and the carrying strap in its storage arrangement.

1 Claim, 7 Drawing Sheets

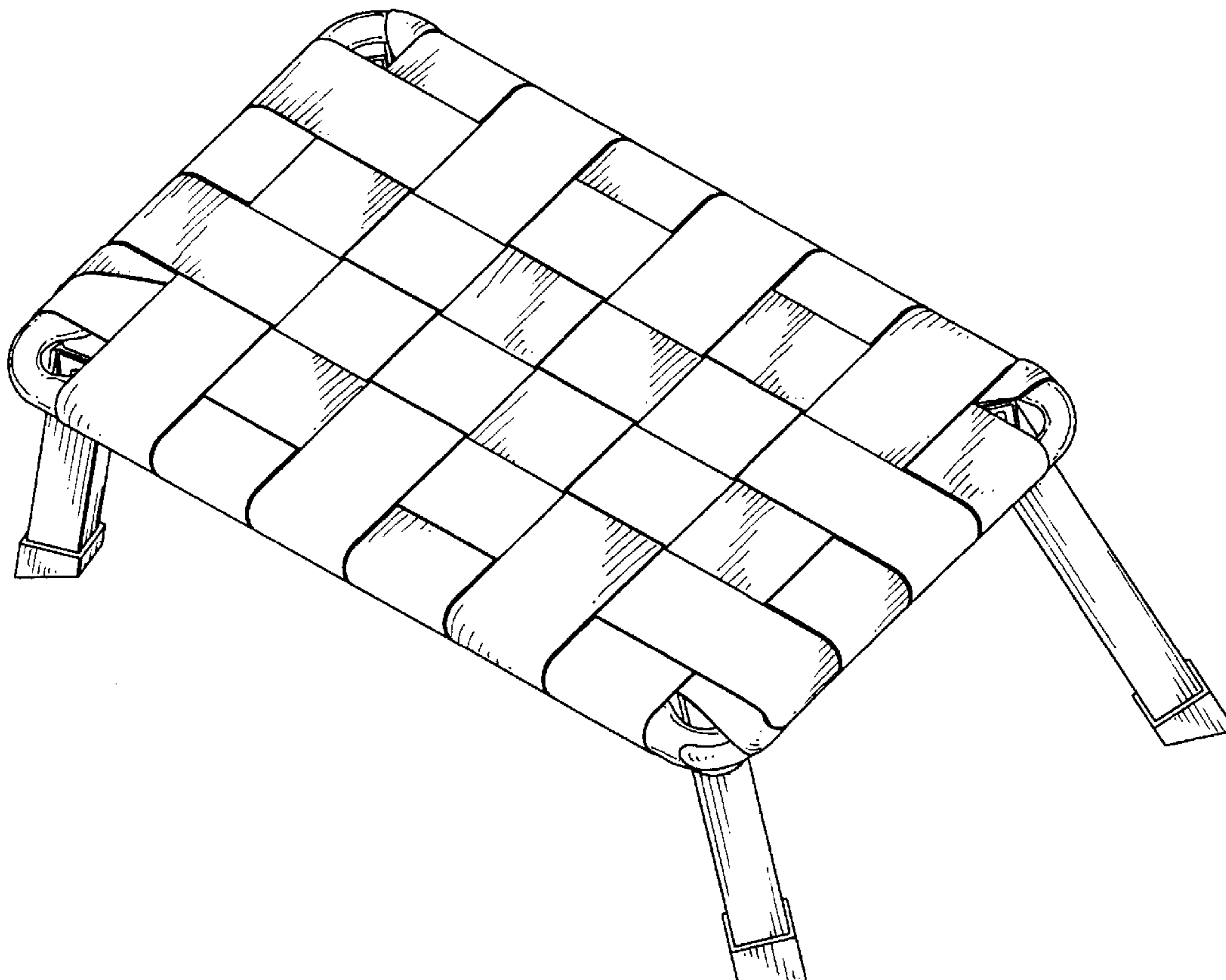

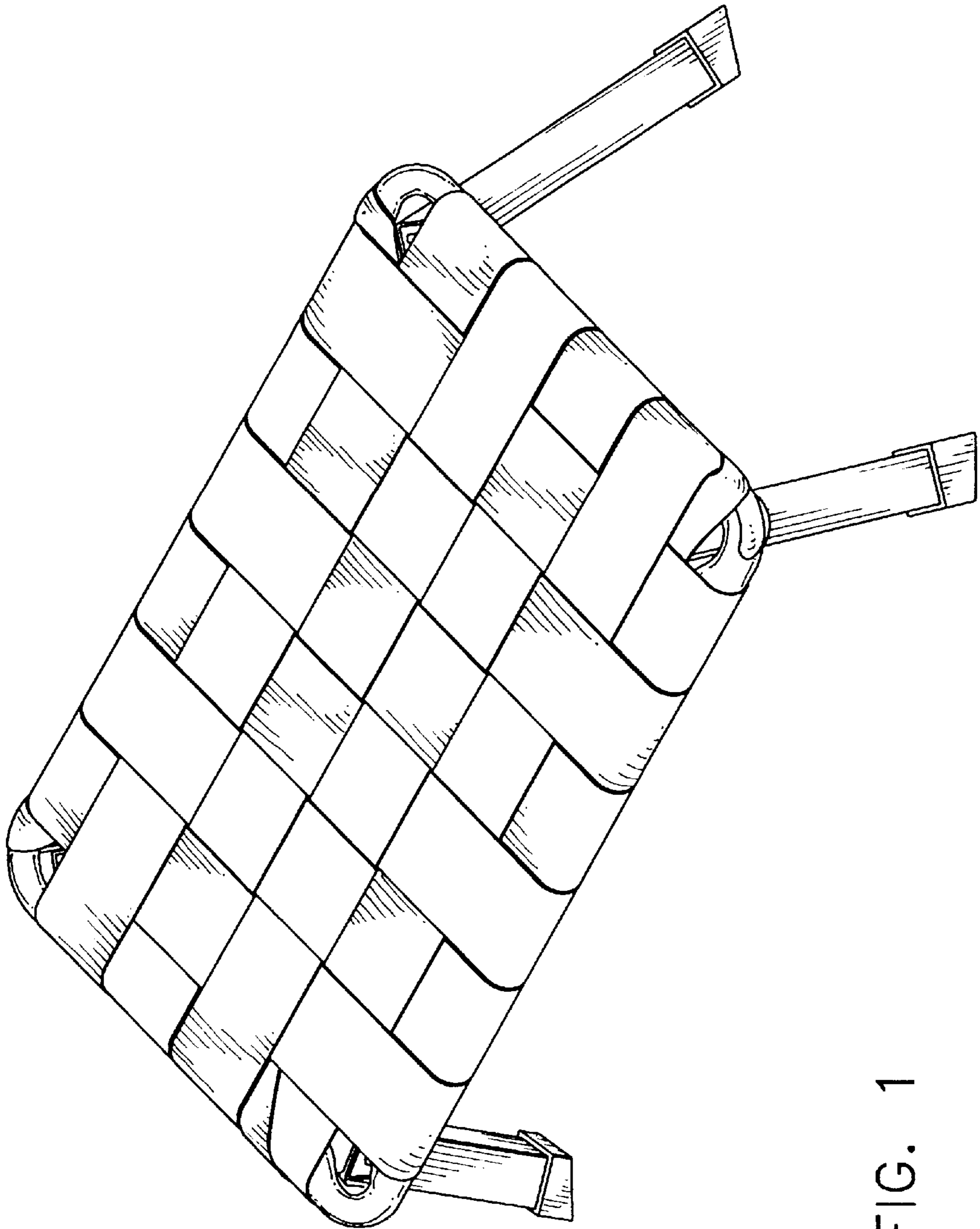

FIG. 1

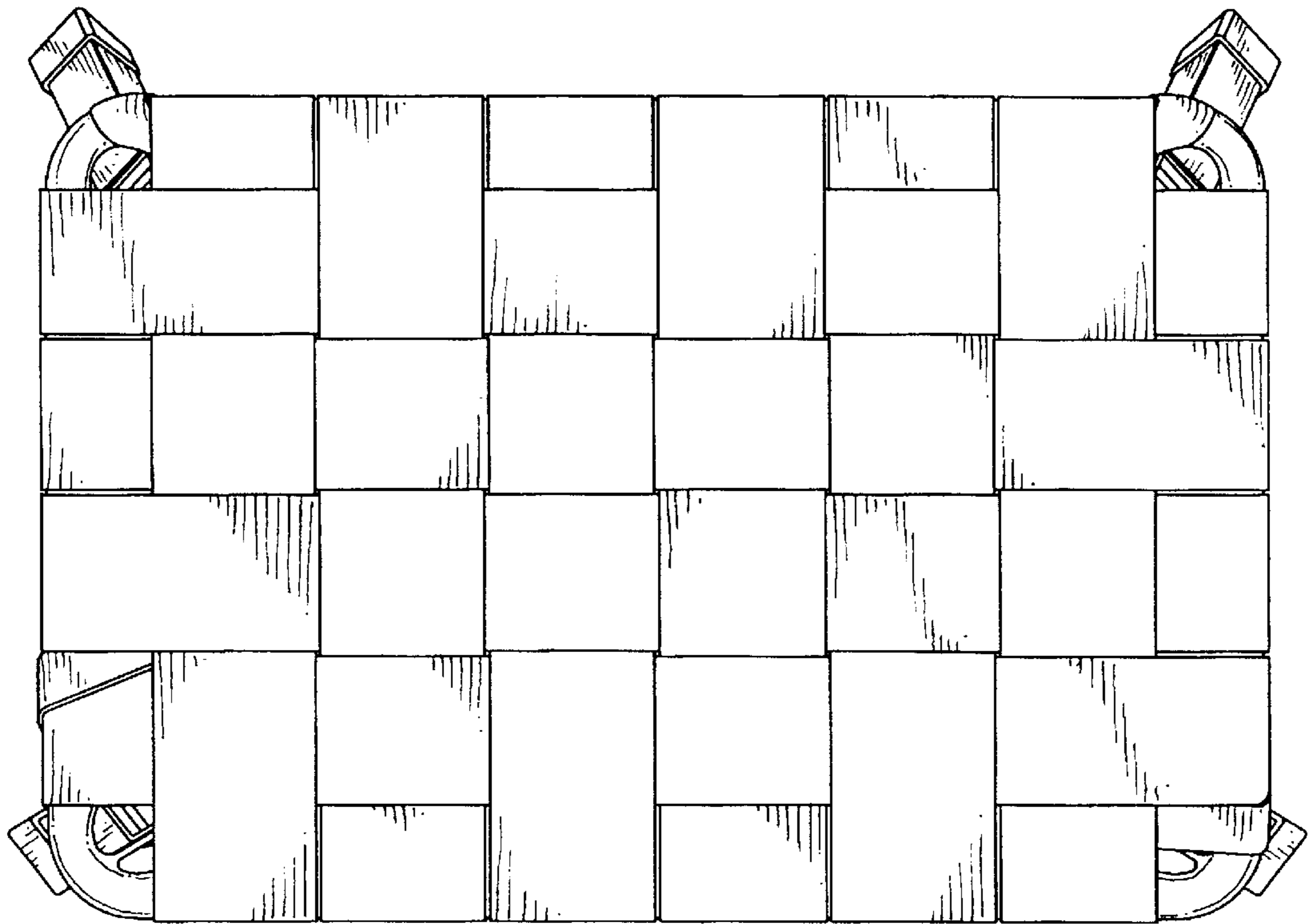

FIG. 2

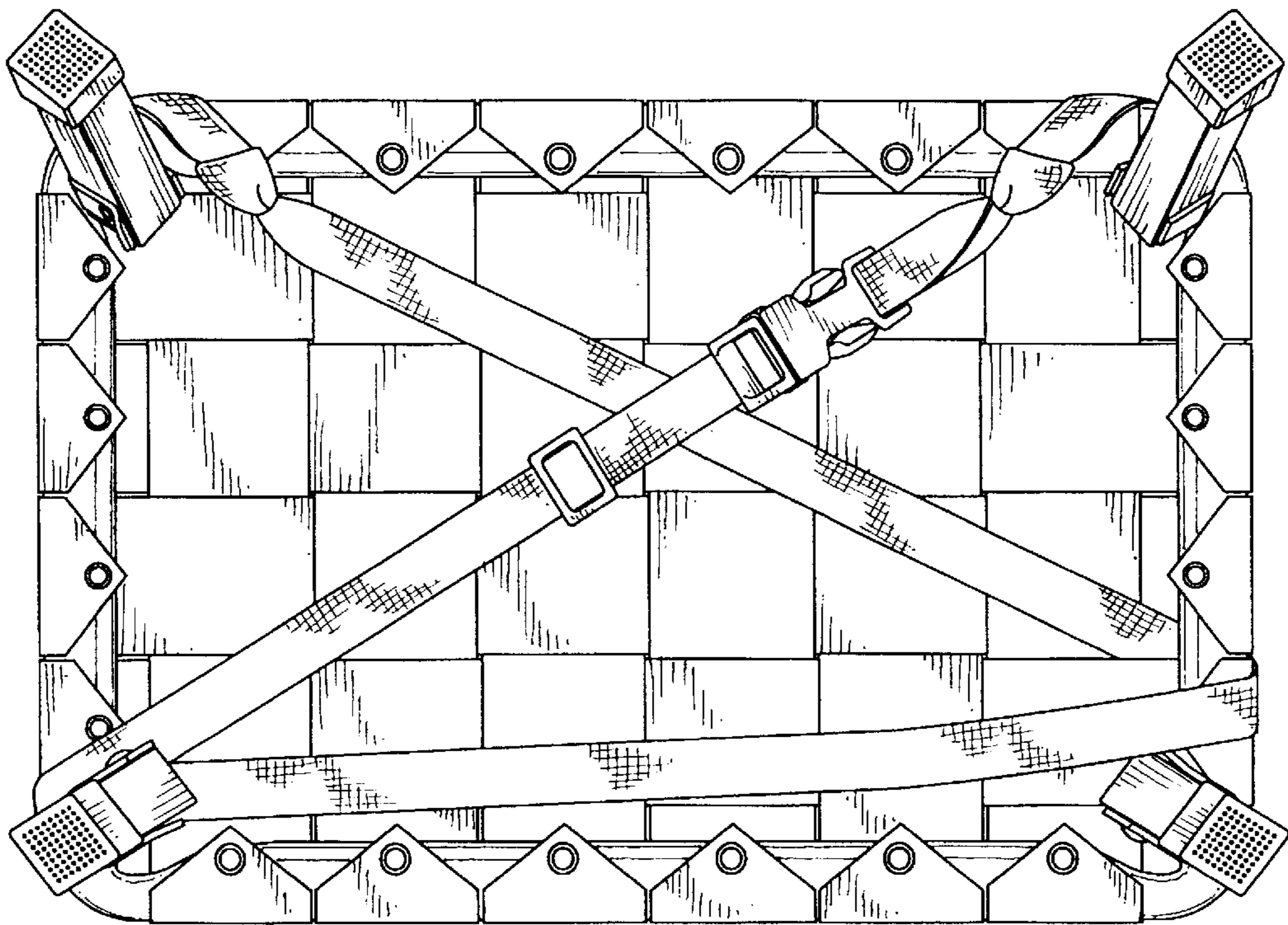

FIG. 3

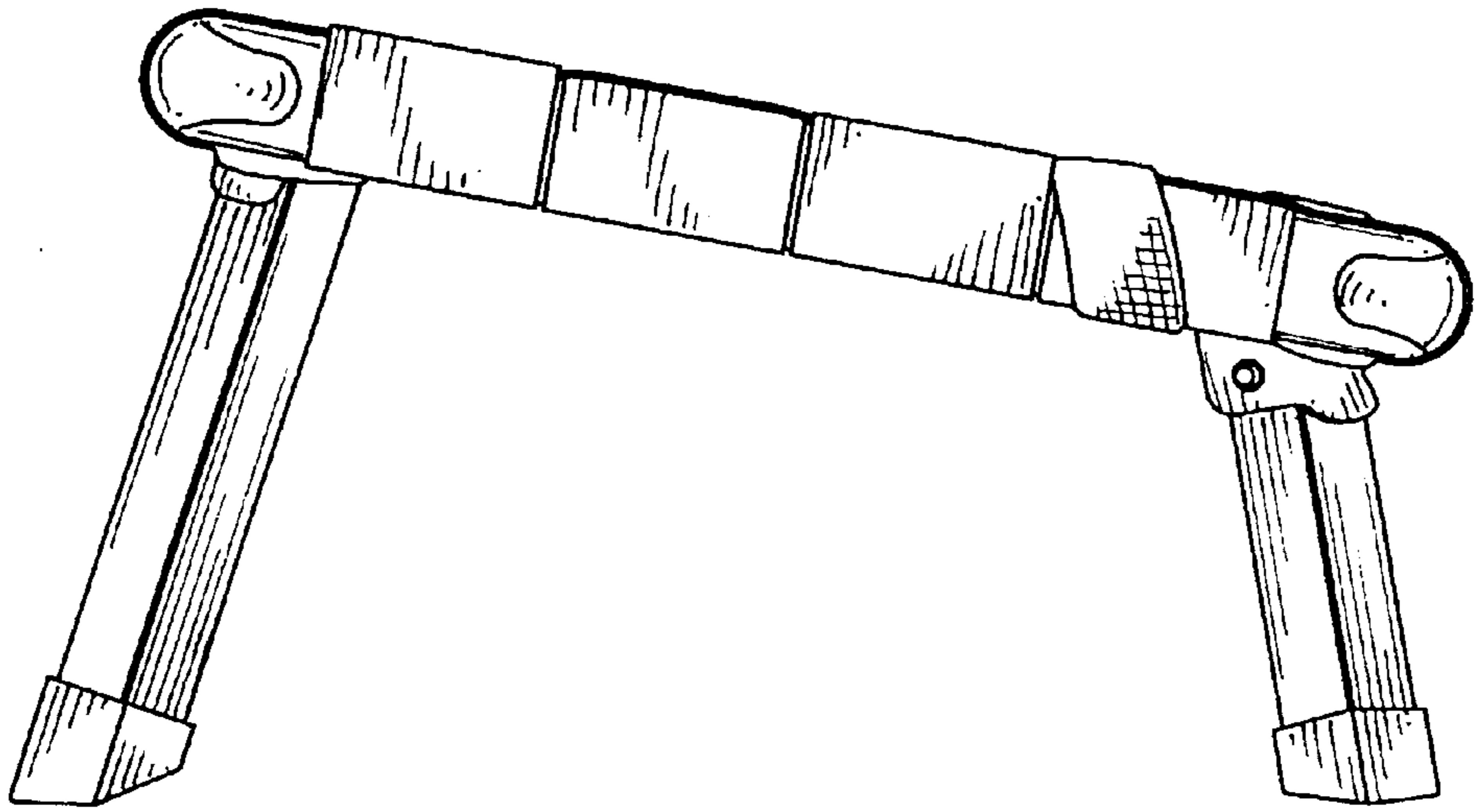

FIG. 4

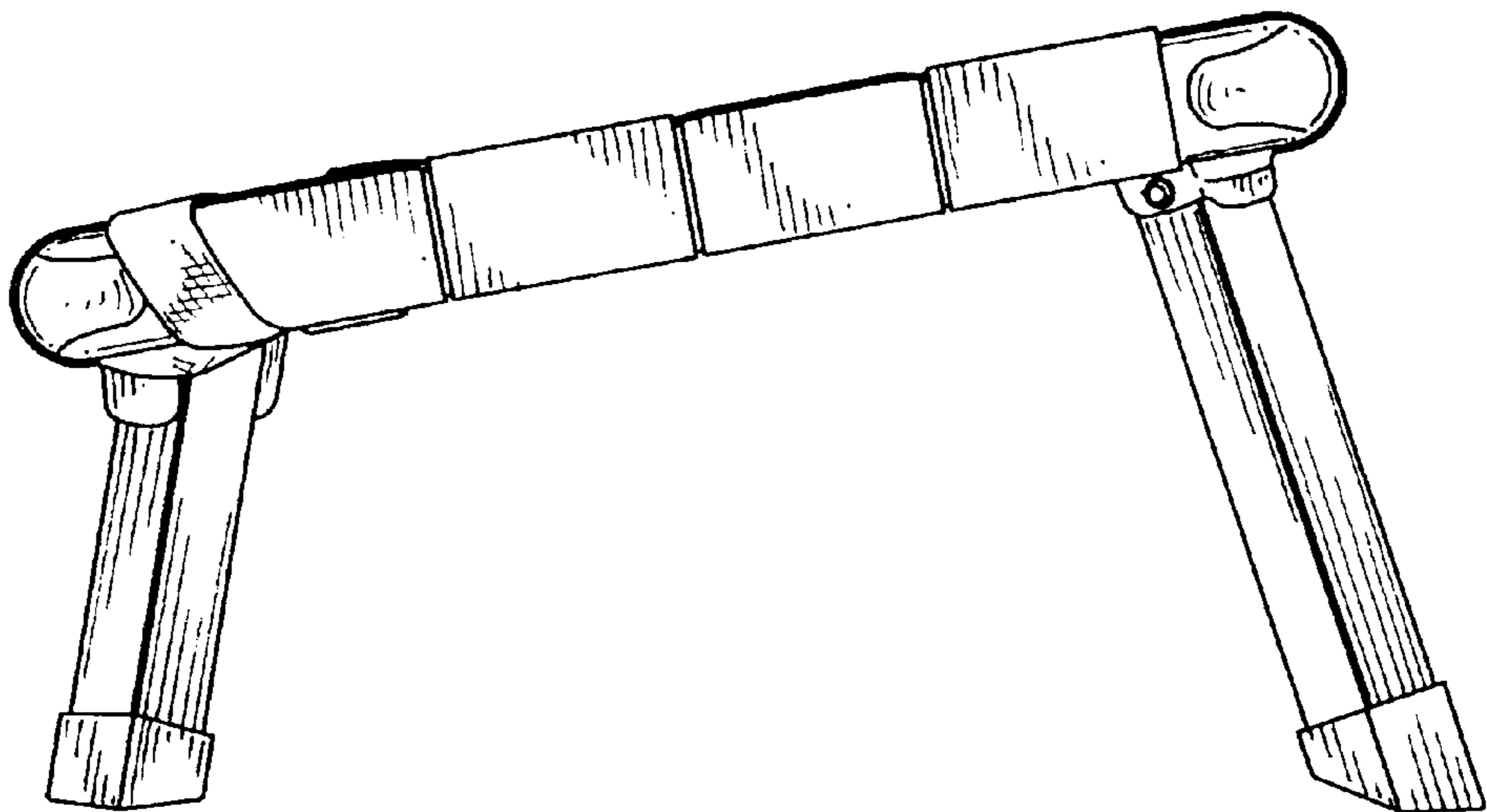

FIG. 5

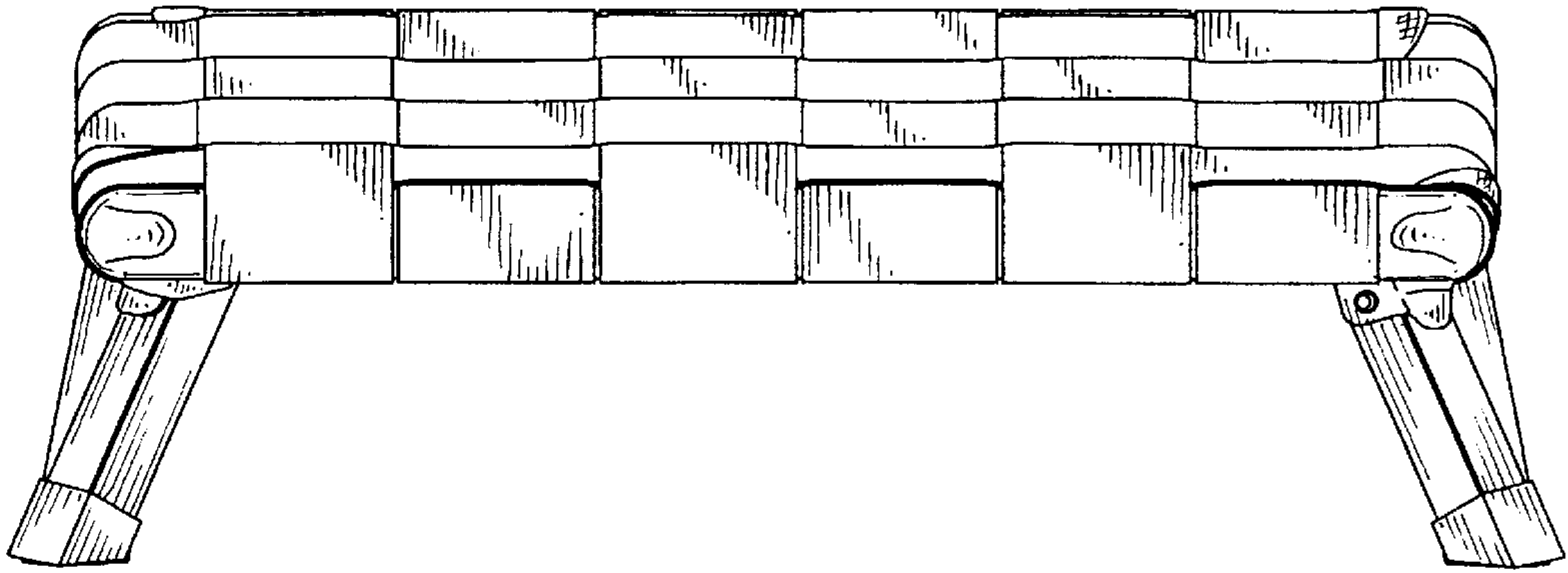

FIG. 6

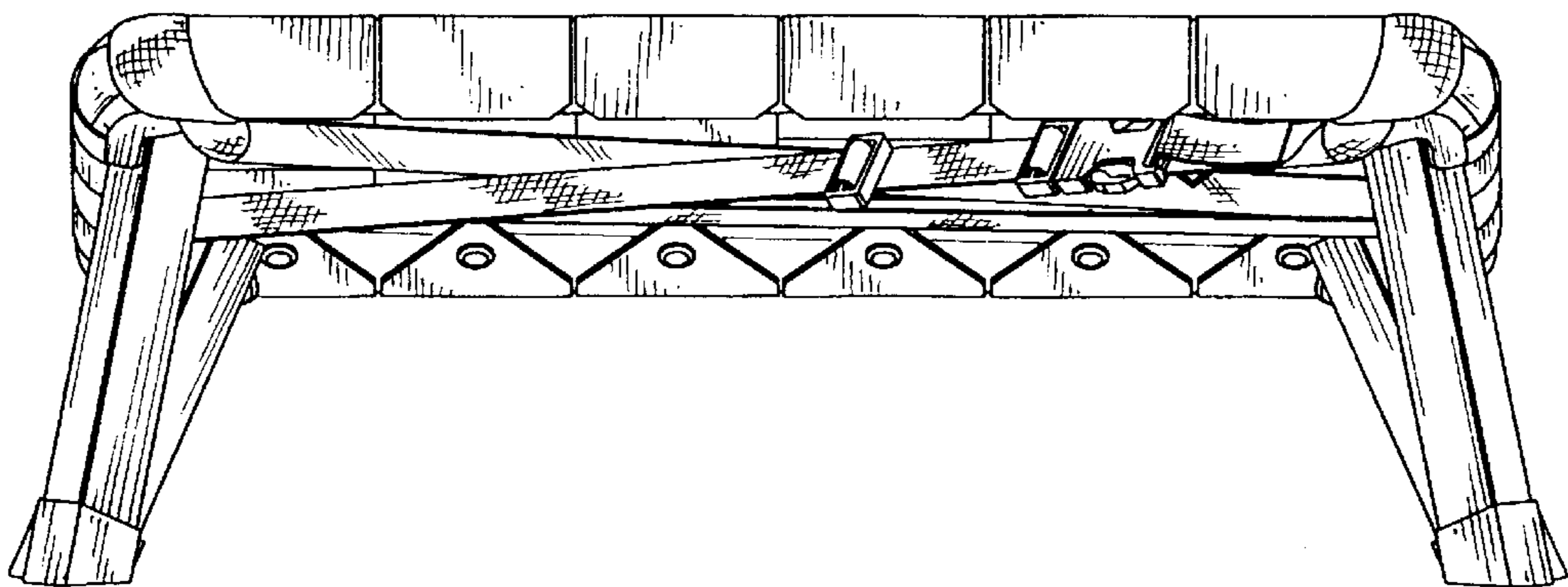

FIG. 7

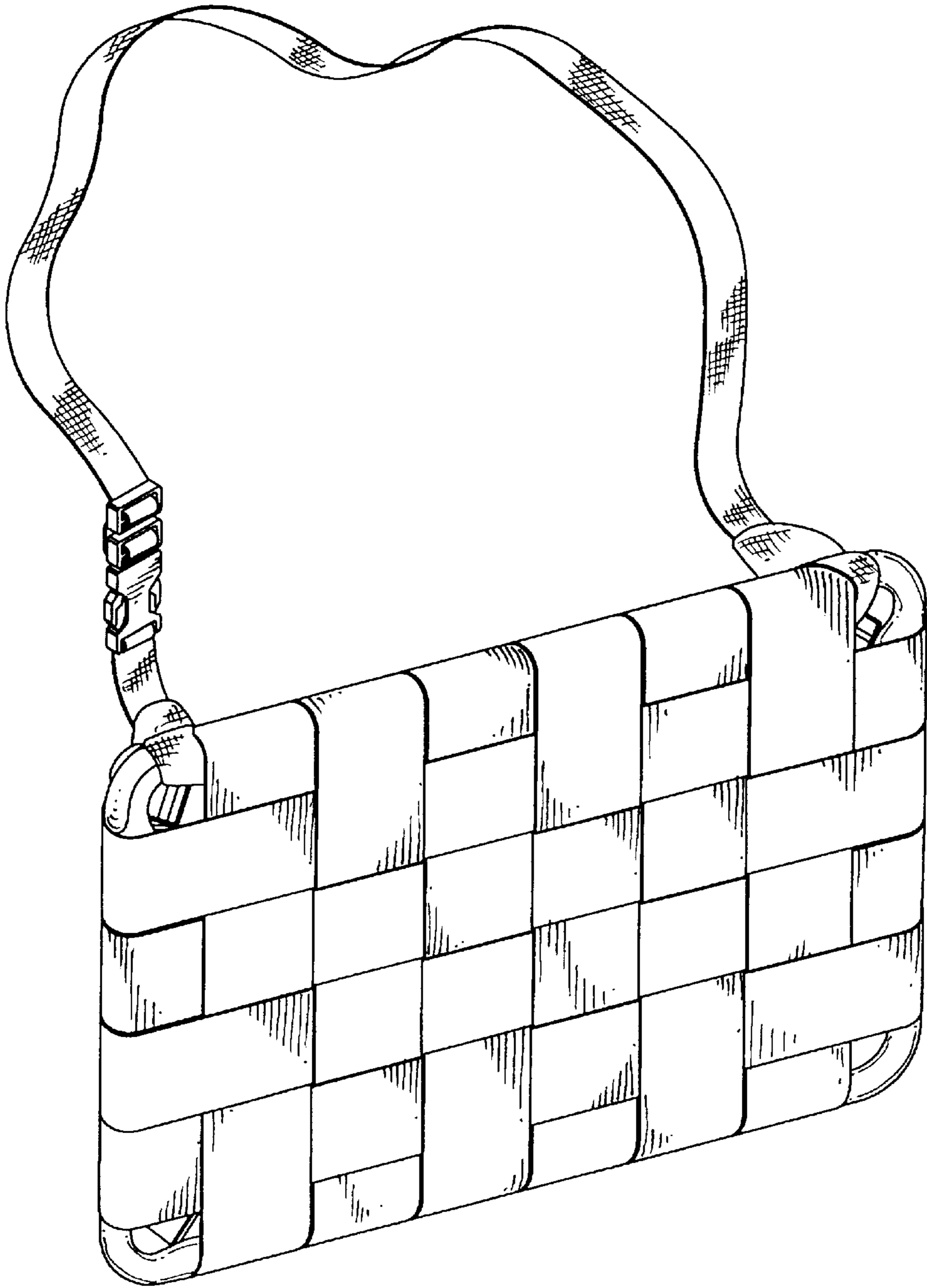

FIG. 8

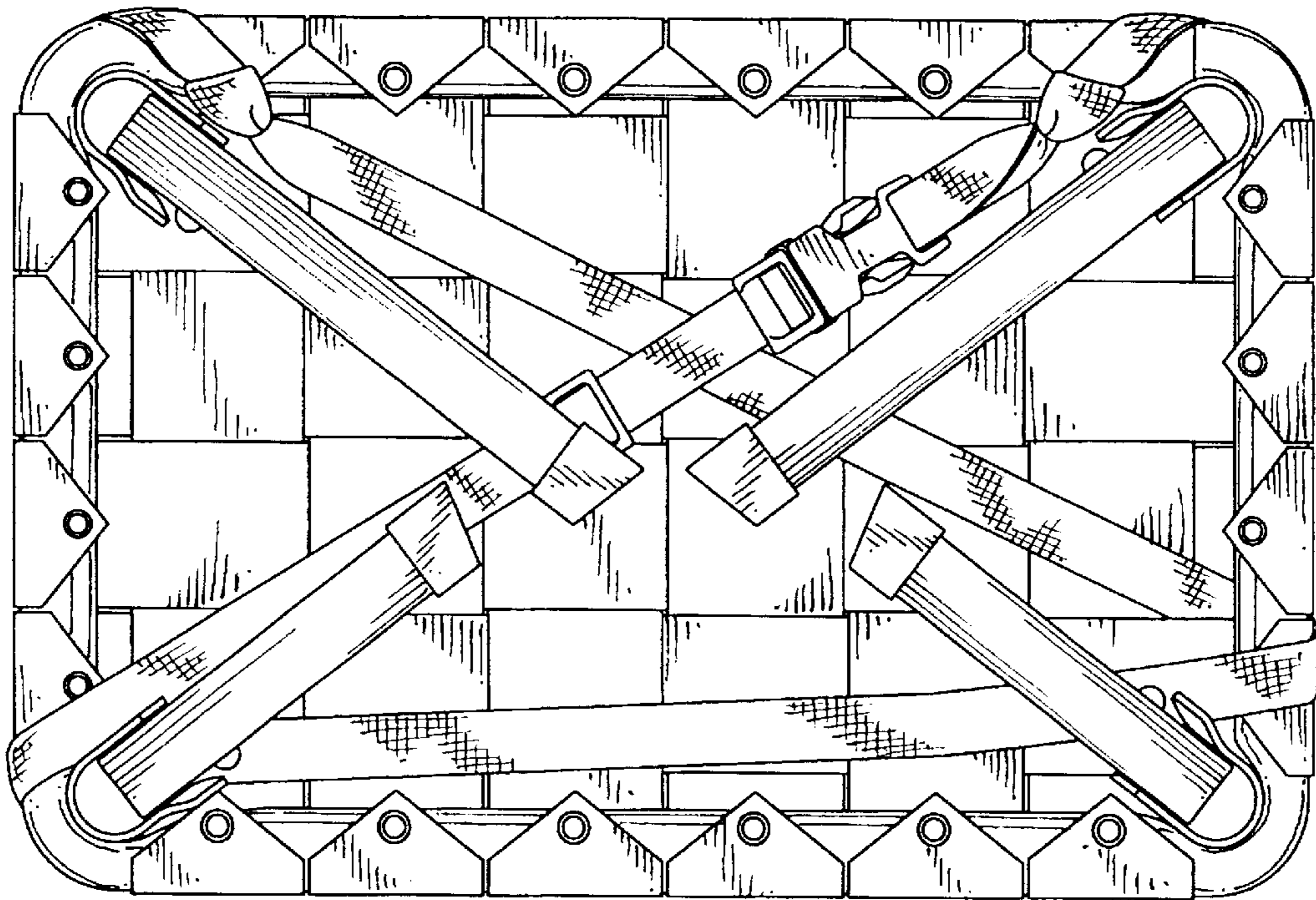

FIG. 9