



US00D477841S

(12) **United States Design Patent**
Shimizu et al.

(10) **Patent No.: US D477,841 S**

(45) **Date of Patent: ** Jul. 29, 2003**

(54) **INK TANK FOR INK JET RECORDING APPARATUS**

(75) Inventors: **Eiichiro Shimizu, Yokohama (JP); Hiroshi Koshikawa, Kawasaki (JP); Masanori Takenouchi, Yokohama (JP)**

(73) Assignee: **Canon Kabushiki Kaisha, Tokyo (JP)**

(**) Term: **14 Years**

(21) Appl. No.: **29/157,626**

(22) Filed: **Mar. 25, 2002**

(30) **Foreign Application Priority Data**

Sep. 27, 2001 (JP) 2001-028182

(51) **LOC (7) Cl. 18-02**

(52) **U.S. Cl. D18/56; 347/86**

(58) **Field of Search D18/56, 43; 347/86, 347/87, 50, 33, 99**

(56) **References Cited**

U.S. PATENT DOCUMENTS

D314,973 S	2/1991	Yamamoto	D18/56
D351,190 S	* 10/1994	Oshima et al.	D18/56
D371,160 S	6/1996	Kotaki et al.	D18/56
D371,803 S	7/1996	Kawashima et al.	D18/56
D371,804 S	7/1996	Kotaki et al.	D18/56
D372,045 S	7/1996	Tokuda et al.	D18/56
D372,265 S	7/1996	Tokuda et al.	D18/56
D372,266 S	7/1996	Tokuda et al.	D18/56
D372,267 S	7/1996	Tokuda et al.	D18/56
D372,494 S	8/1996	Tokuda et al.	D18/56
D373,138 S	8/1996	Tokuda et al.	D18/56
D374,890 S	10/1996	Tokuda et al.	D18/56
D375,120 S	10/1996	Kotaki et al.	D18/56
D375,521 S	11/1996	Tokuda et al.	D18/56
D375,522 S	11/1996	Tokuda et al.	D18/56
D375,755 S	11/1996	Tokuda et al.	D18/56
D376,172 S	12/1996	Takenouchi et al.	D18/56
D376,173 S	12/1996	Tokuda et al.	D18/56

D376,174 S	12/1996	Tokuda et al.	D18/56
D377,371 S	1/1997	Tokuda et al.	D18/56
D378,758 S	4/1997	Tokuda et al.	D18/56
D381,039 S	* 7/1997	Shinada et al.	D18/56
D381,681 S	7/1997	Takenouchi et al.	D18/56
D395,445 S	6/1998	Tokuda et al.	D18/56
D440,600 S	* 4/2001	Seino et al.	D18/56
D442,219 S	* 5/2001	Chou et al.	D18/56
D442,221 S	* 5/2001	Seino et al.	D18/56
D443,639 S	* 6/2001	Chou et al.	D18/56
D446,545 S	* 8/2001	Tanaka	D18/56
6,273,560 B1	* 8/2001	Keefe et al.	347/86
6,325,491 B1	* 12/2001	Feinn	347/50
D453,184 S	* 1/2002	Ito et al.	D18/56
D454,363 S	* 3/2002	Seino et al.	D18/56
D455,780 S	* 4/2002	Seino et al.	D18/56
D456,836 S	* 5/2002	Ito et al.	D18/56
6,422,691 B2	* 7/2002	Kobayashi et al.	347/86

FOREIGN PATENT DOCUMENTS

JP 826701 1/1992

* cited by examiner

Primary Examiner—Cathy Anne MacCormac

(74) *Attorney, Agent, or Firm*—Fitzpatrick, Cella, Harper & Scinto

(57) **CLAIM**

The ornamental design for an ink tank for ink jet recording apparatus, as shown and described.

DESCRIPTION

FIG. 1 is a front view of an ink tank for ink jet recording apparatus showing our new design; FIG. 2 is a rear view thereof; FIG. 3 is a top plan view thereof; FIG. 4 is a bottom plan view thereof; FIG. 5 is a left side view thereof; FIG. 6 is a right side view thereof; and, FIG. 7 is a perspective view thereof.

1 Claim, 5 Drawing Sheets

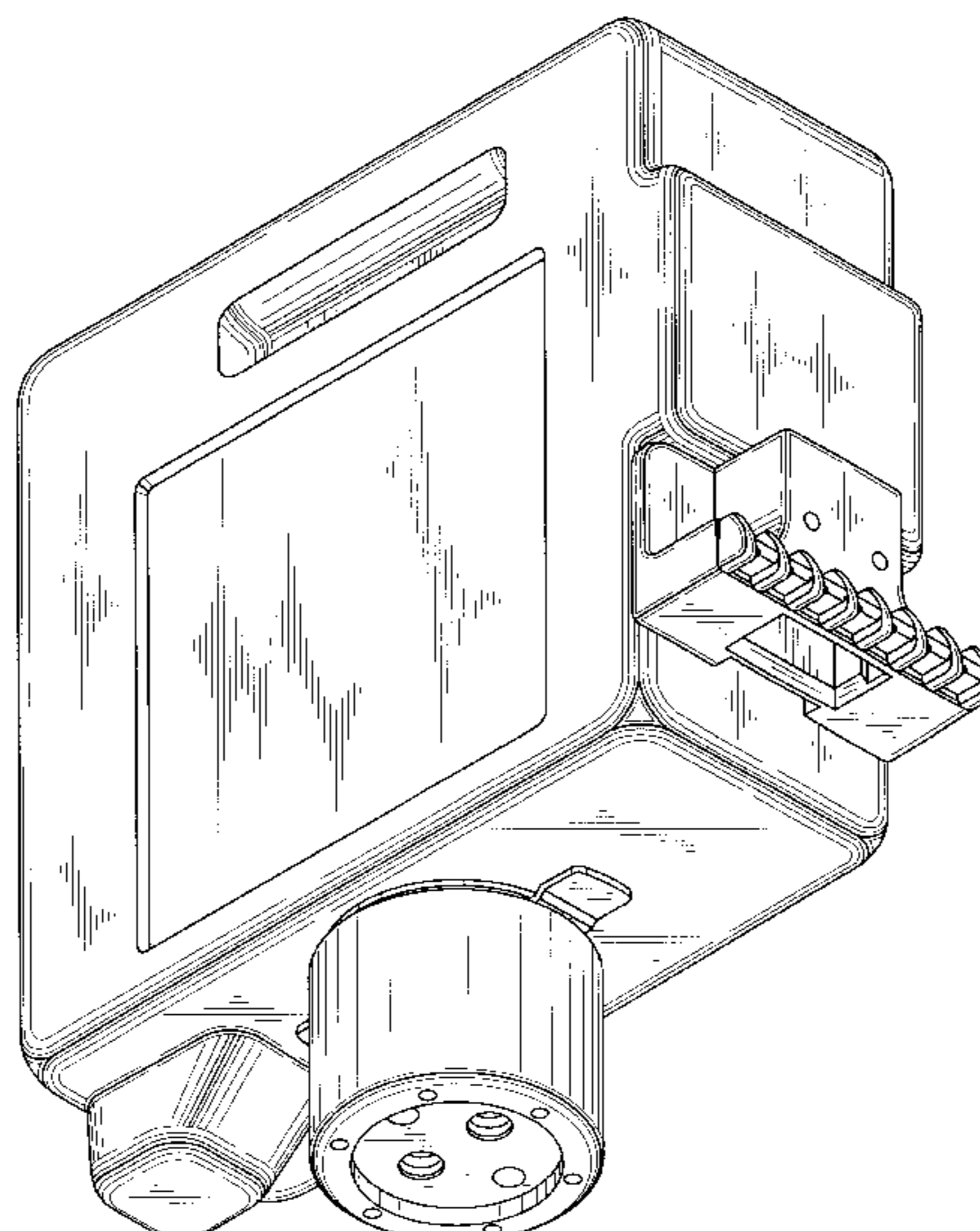

FIG. 1

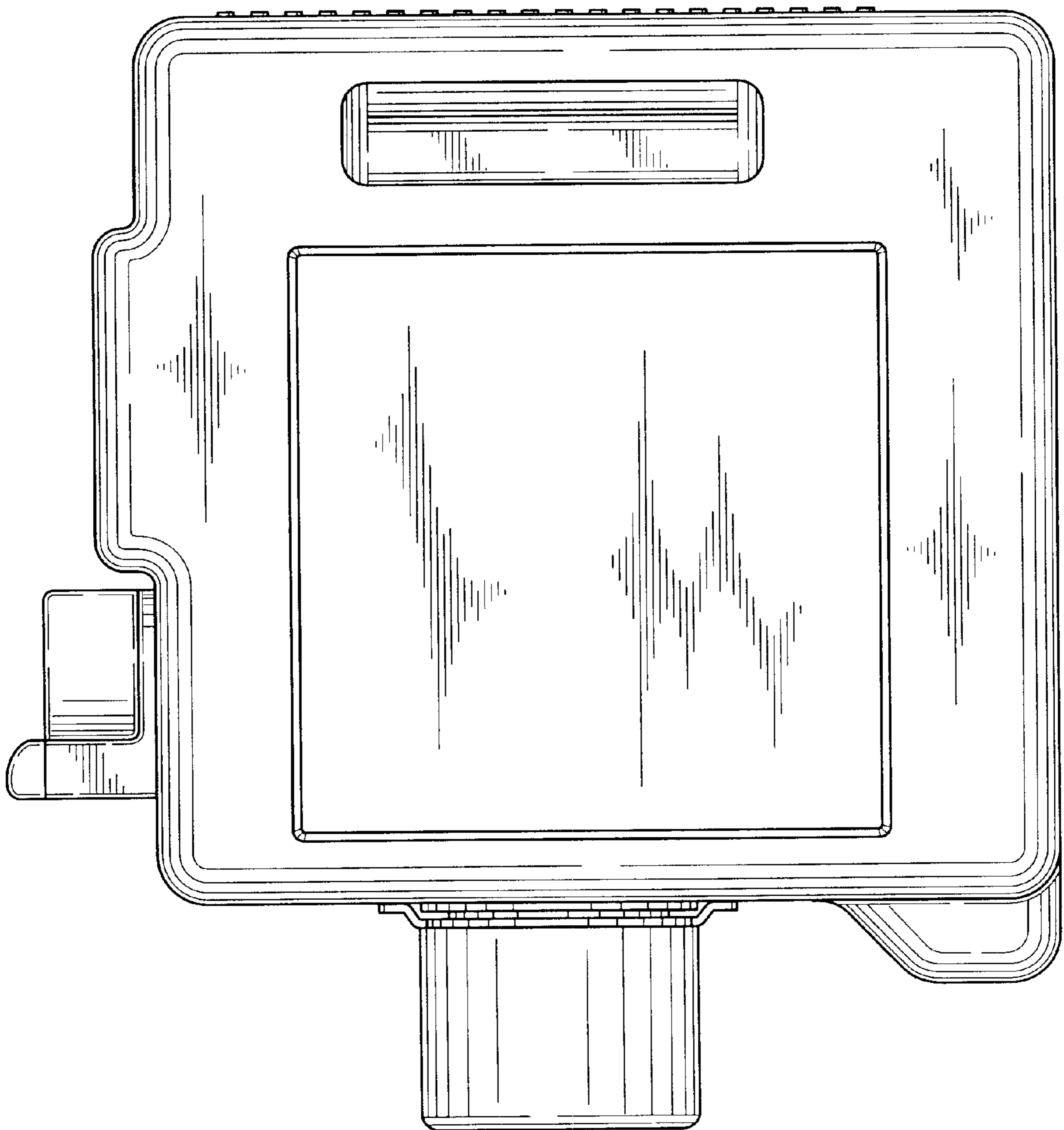

FIG. 2

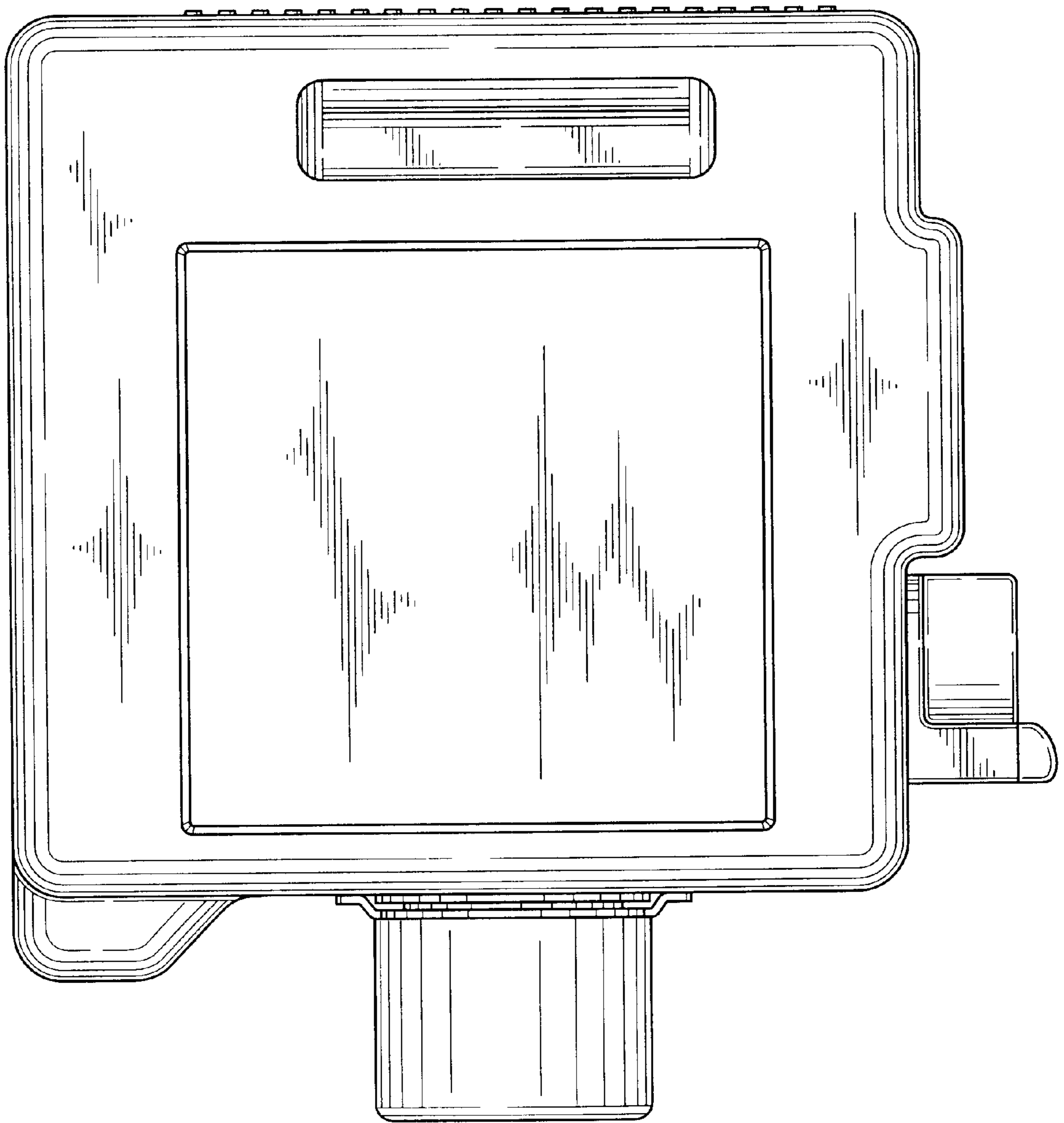

FIG. 3

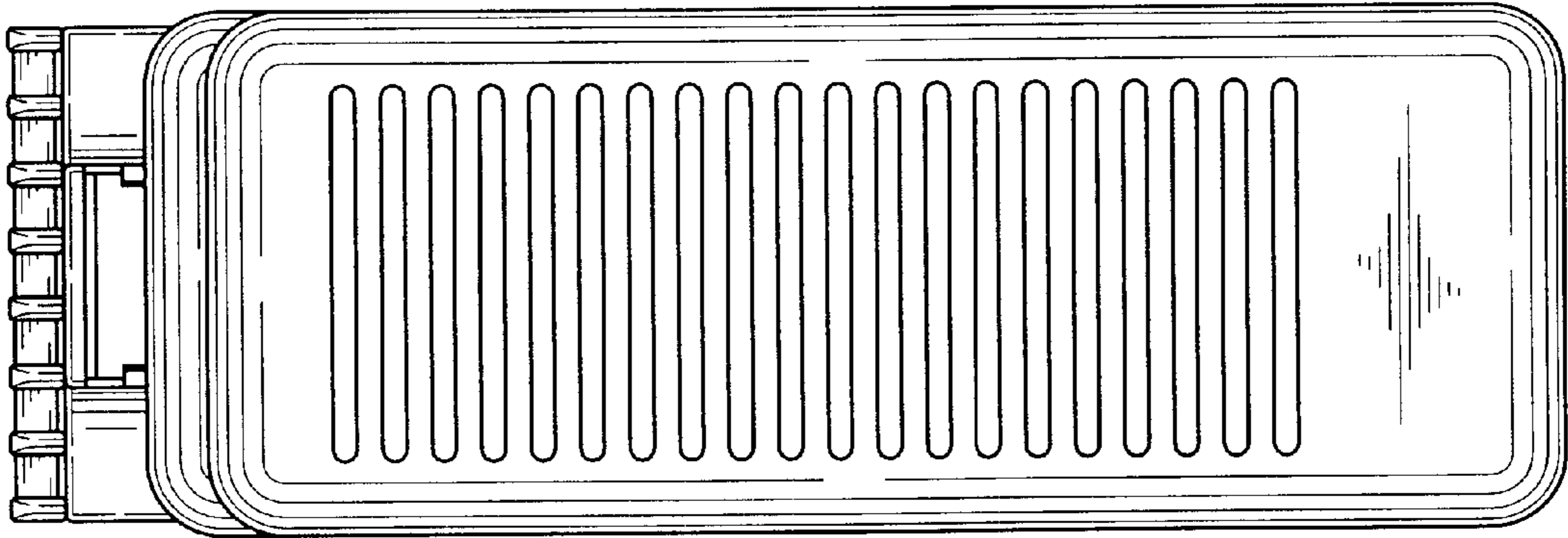

FIG. 4

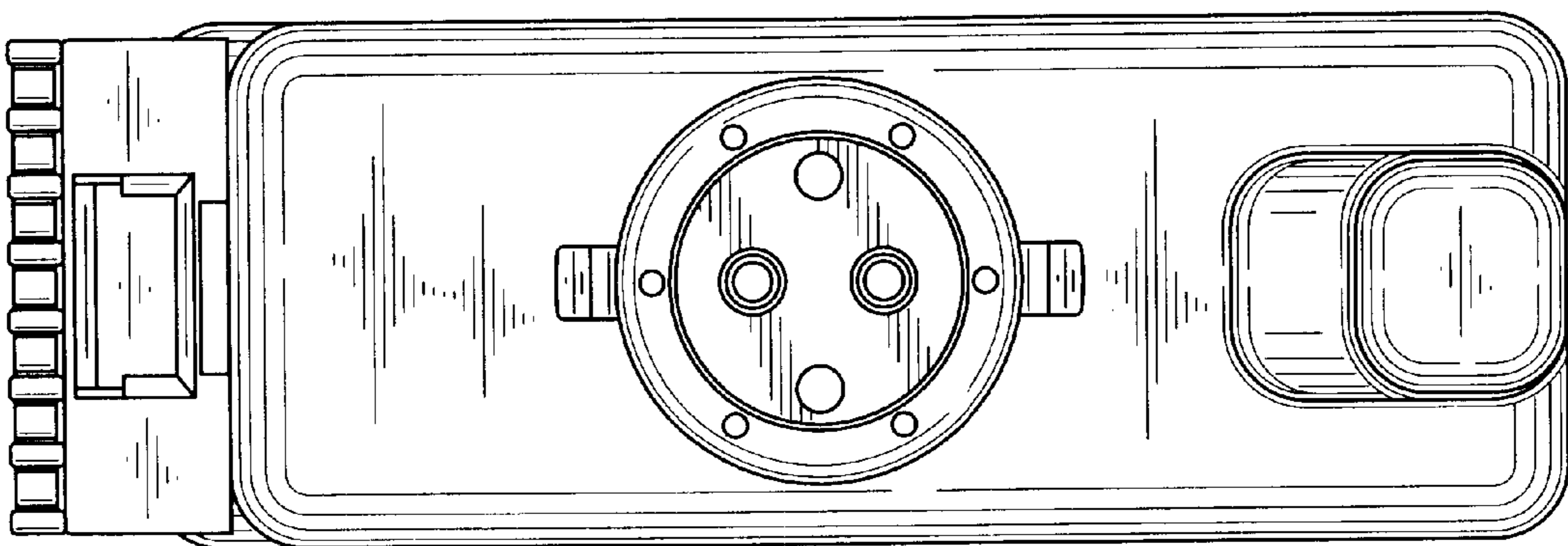

FIG. 5

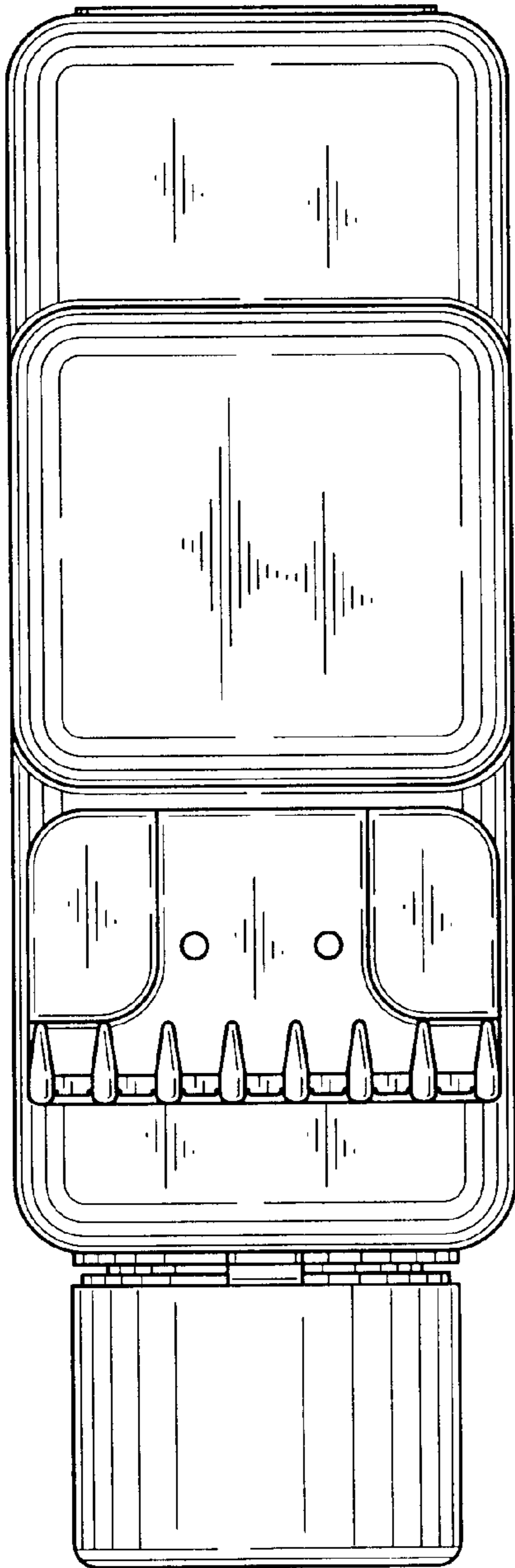

FIG. 6

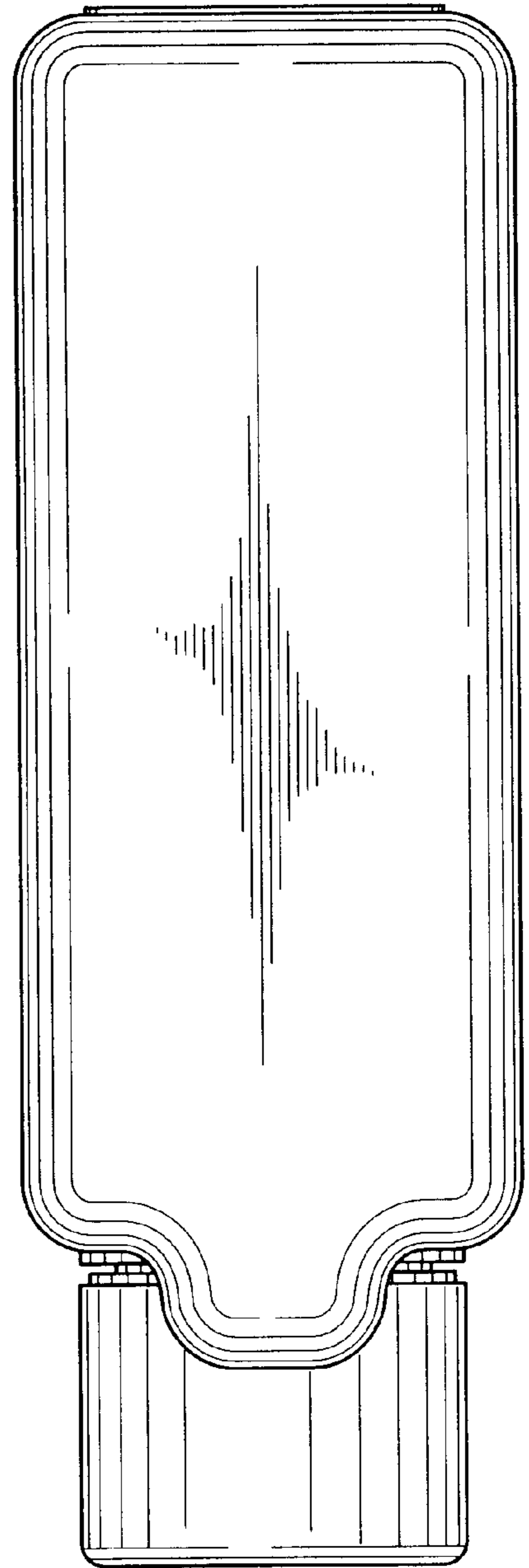

FIG. 7

