



US00D477785S

(12) **United States Design Patent**
Szumer

(10) **Patent No.:** **US D477,785 S**

(45) **Date of Patent:** **** Jul. 29, 2003**

(54) **TOOL FOR APPLYING A CHALK LINE**

6,393,709 B1 * 5/2002 Jones 33/414

(75) Inventor: **Manny Szumer**, D.N. Bikat Beit
Hakerem (IL)

* cited by examiner

Primary Examiner—Antoine Duval Davis

(73) Assignee: **Kapro Industries Ltd.**, D.N. Bikat Beit
Hakerem (IL)

(74) *Attorney, Agent, or Firm*—Nixon & Vanderhye

(**) Term: **14 Years**

(57) **CLAIM**

The ornamental design for a “tool for applying a chalk line”,
as shown and described.

(21) Appl. No.: **29/164,631**

DESCRIPTION

(22) Filed: **Jul. 30, 2002**

(51) **LOC (7) Cl.** **10-04**

(52) **U.S. Cl.** **D10/65**

(58) **Field of Search** D10/65, 70, 72;
33/414, 413, 755–760; 242/385.4, 378.1

FIG. 1 is a top, left side and front perspective view of a tool
for applying a chalk line according to my design;

FIG. 2 is a top plan view thereof;

FIG. 3 is a left side elevational view thereof;

FIG. 4 is a right side elevational view thereof;

FIG. 5 is a bottom plan view thereof;

FIG. 6 is a front elevational view thereof;

FIG. 7 is a rear elevational view thereof; and,

FIG. 8 is a view similar to FIG. 1 illustrating a tool handle
in an operable condition.

(56) **References Cited**

U.S. PATENT DOCUMENTS

5,683,055 A * 11/1997 Dufour 33/414 X

D429,471 S * 8/2000 Beyers D10/65

6,289,597 B1 * 9/2001 Beyers 33/414

1 Claim, 8 Drawing Sheets

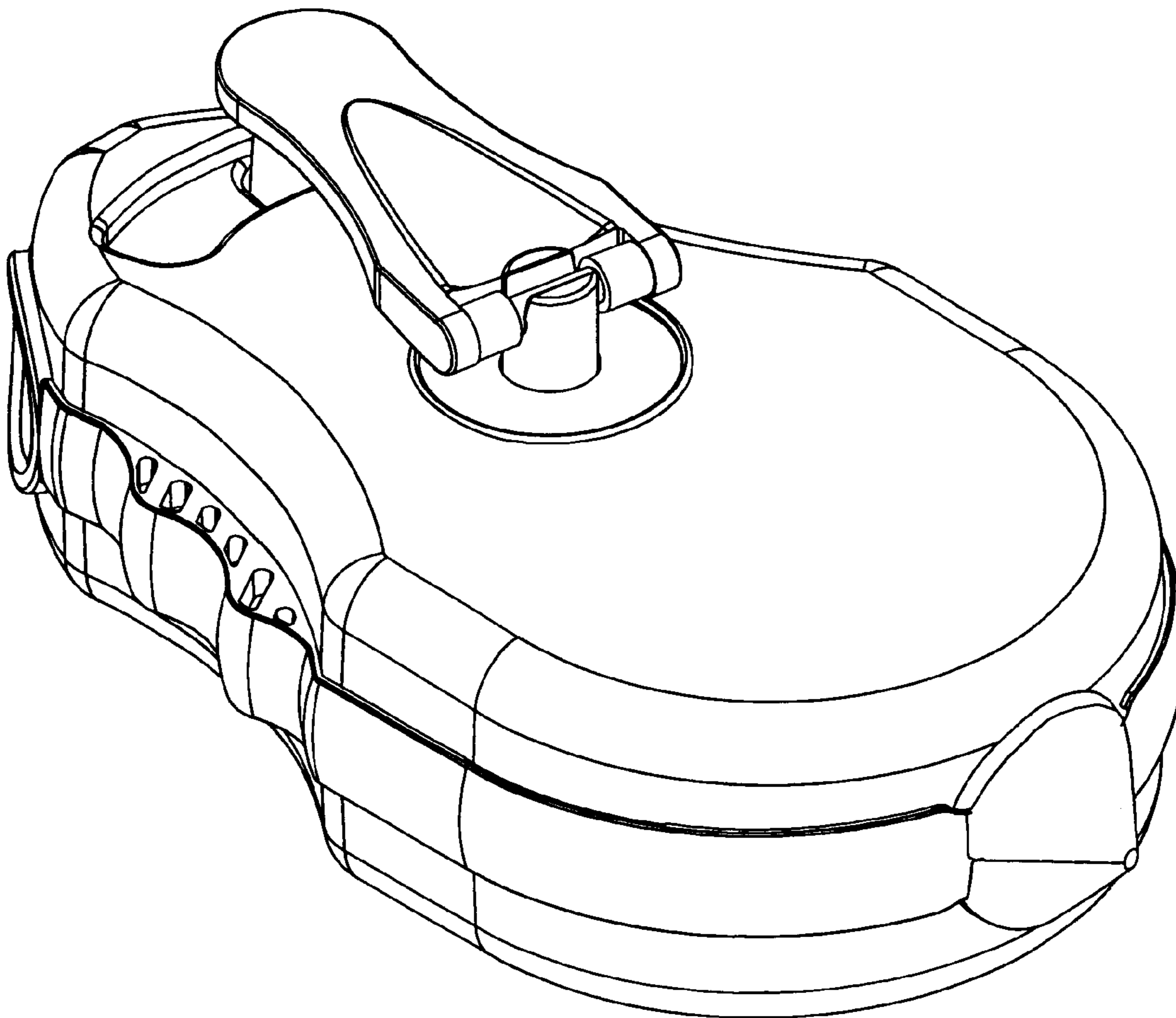

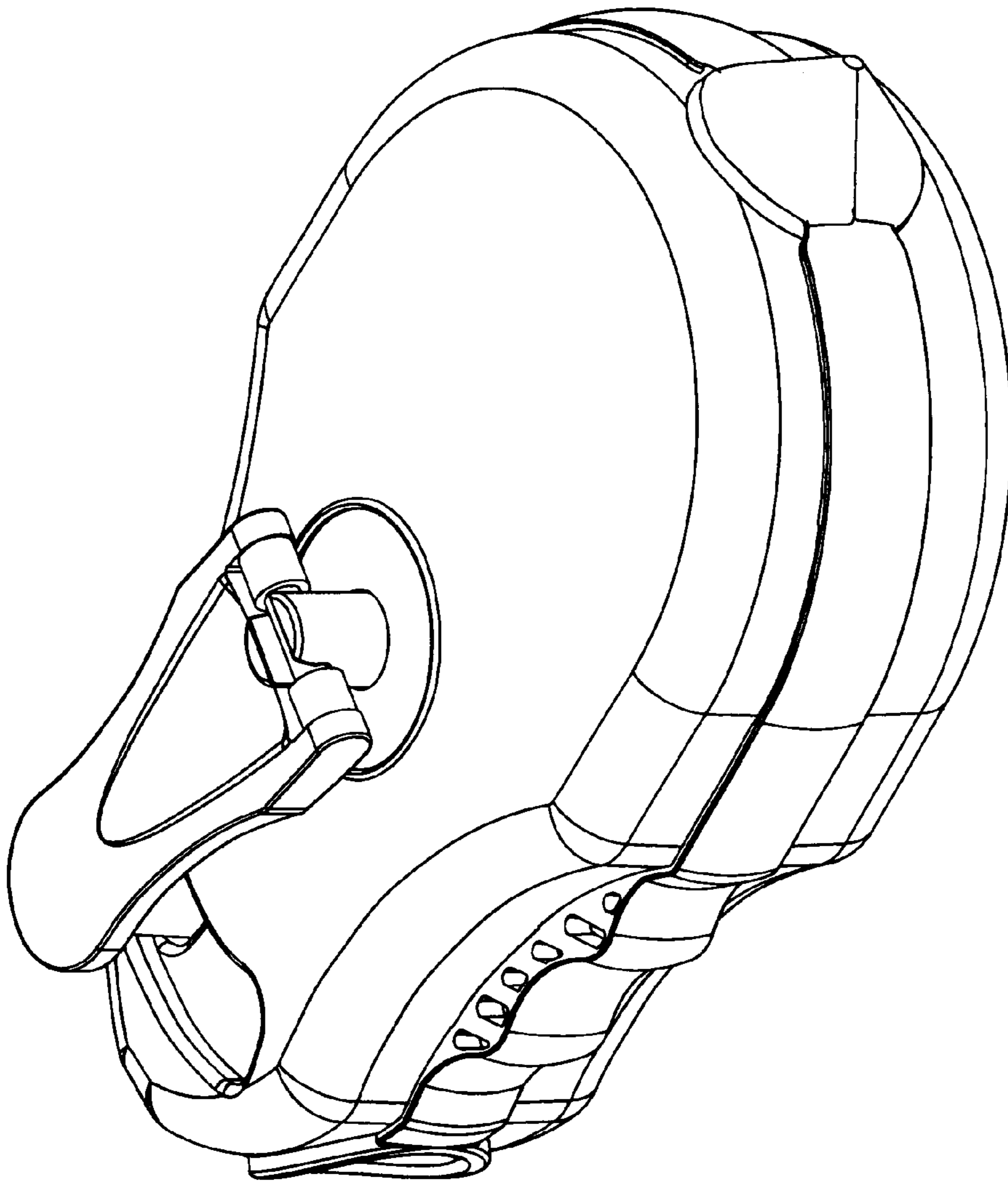

Figure 1

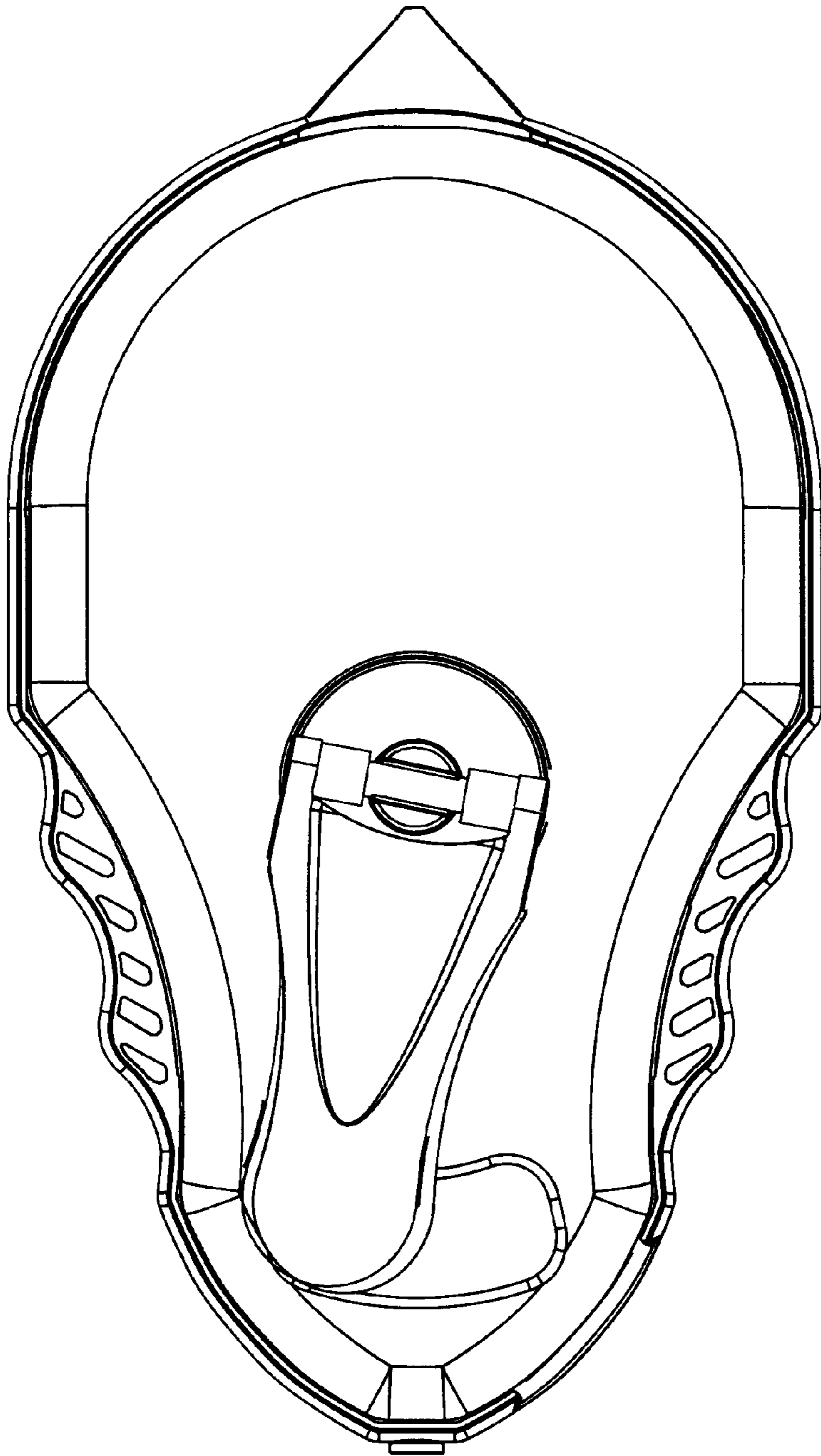

Figure 2

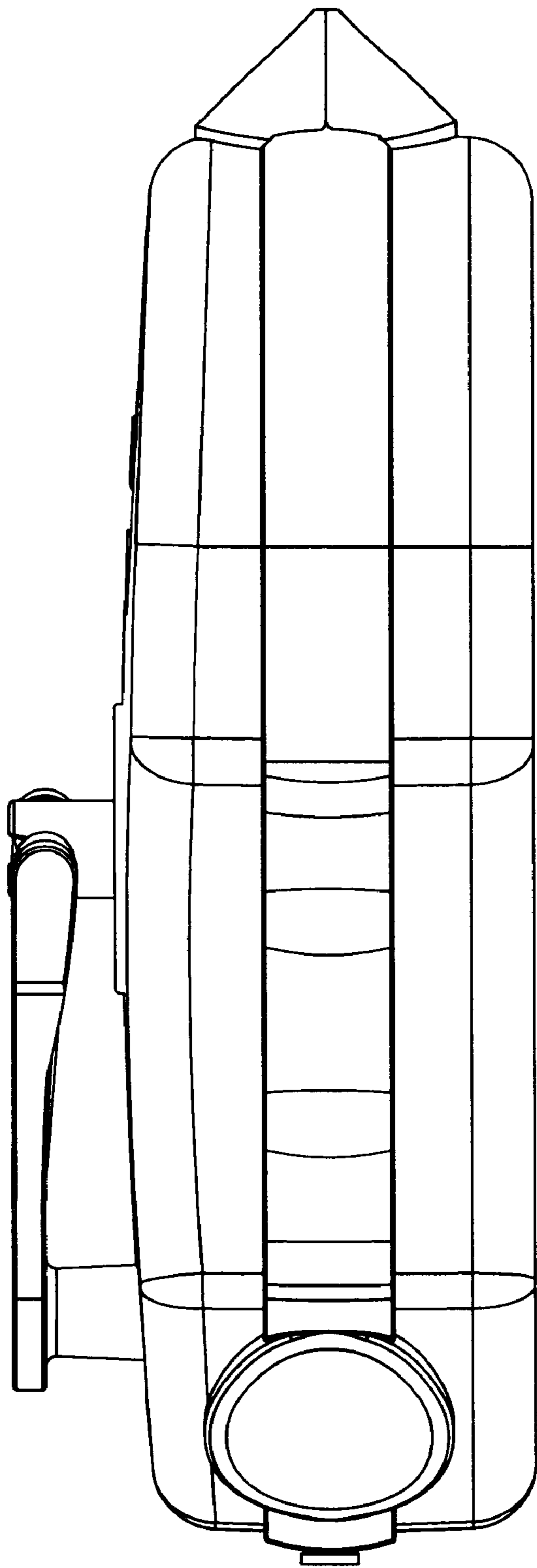

Figure 3

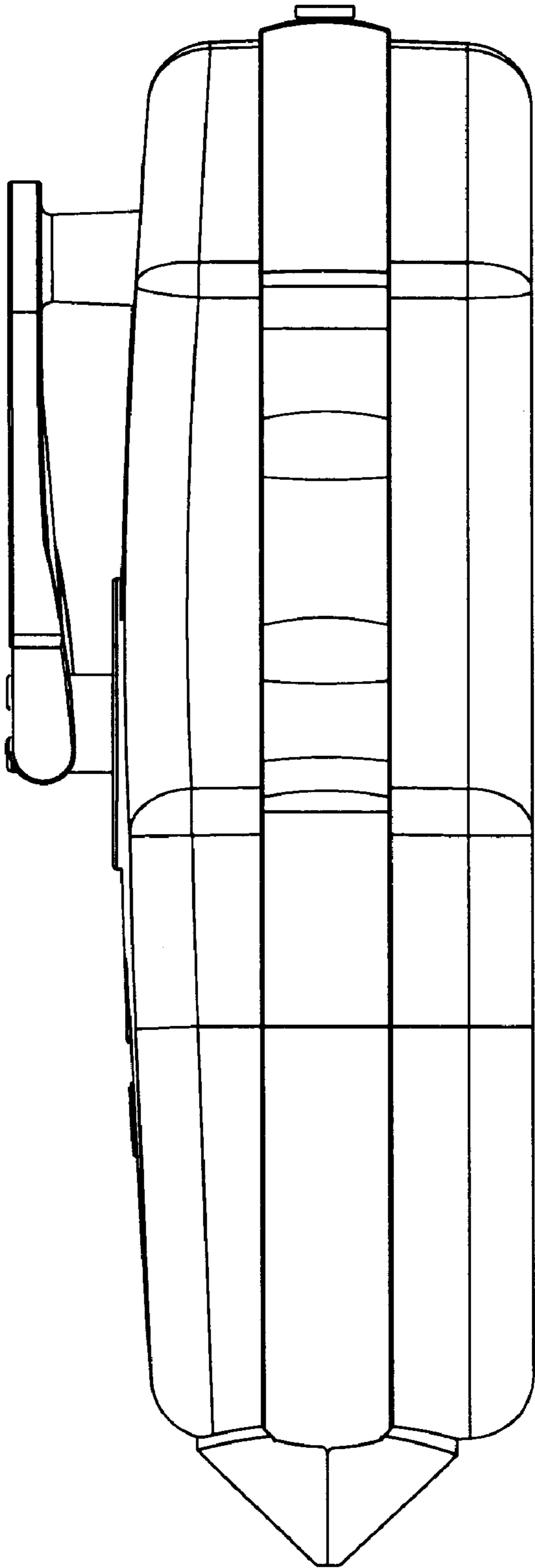

Figure 4

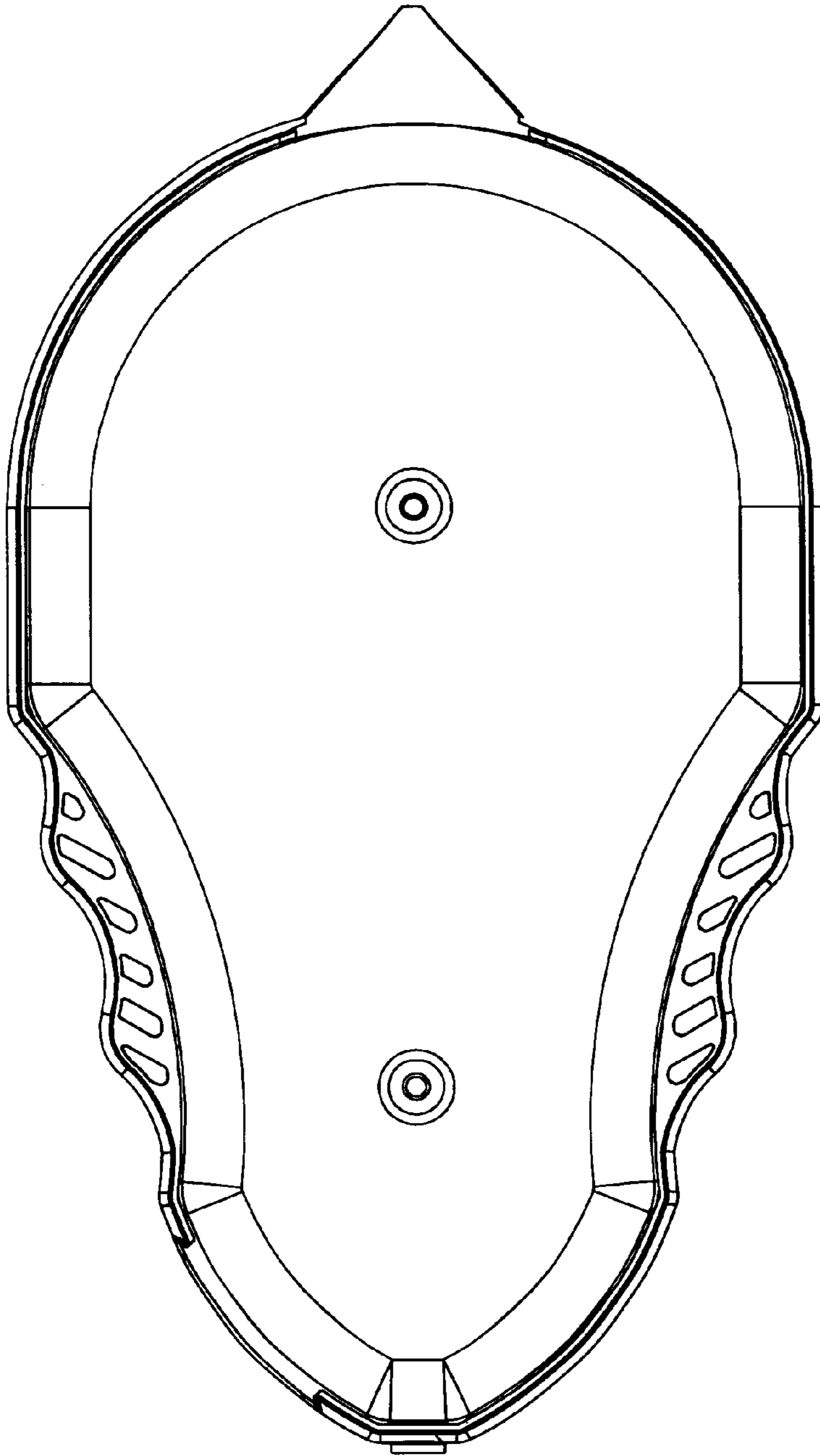

Figure 5

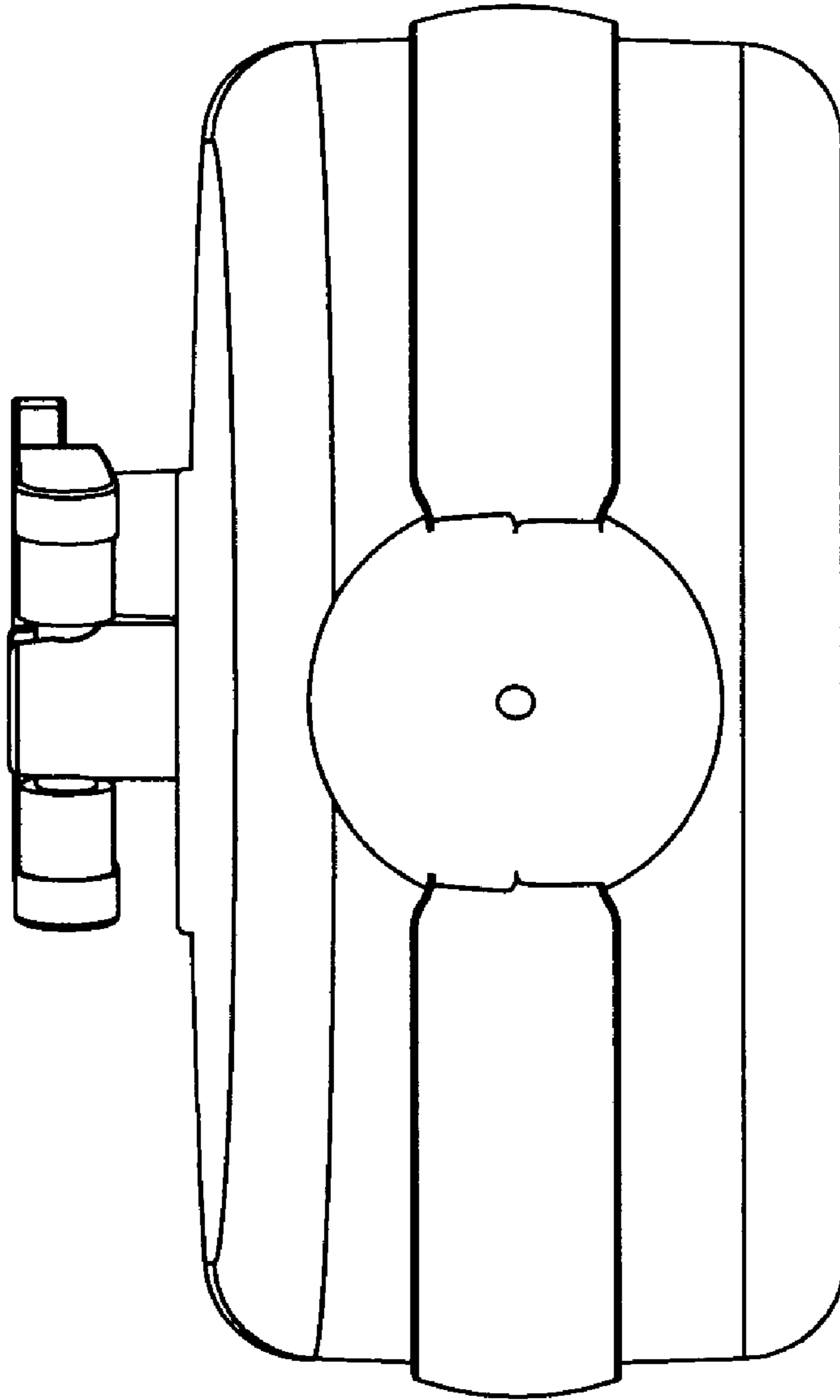

Figure 6

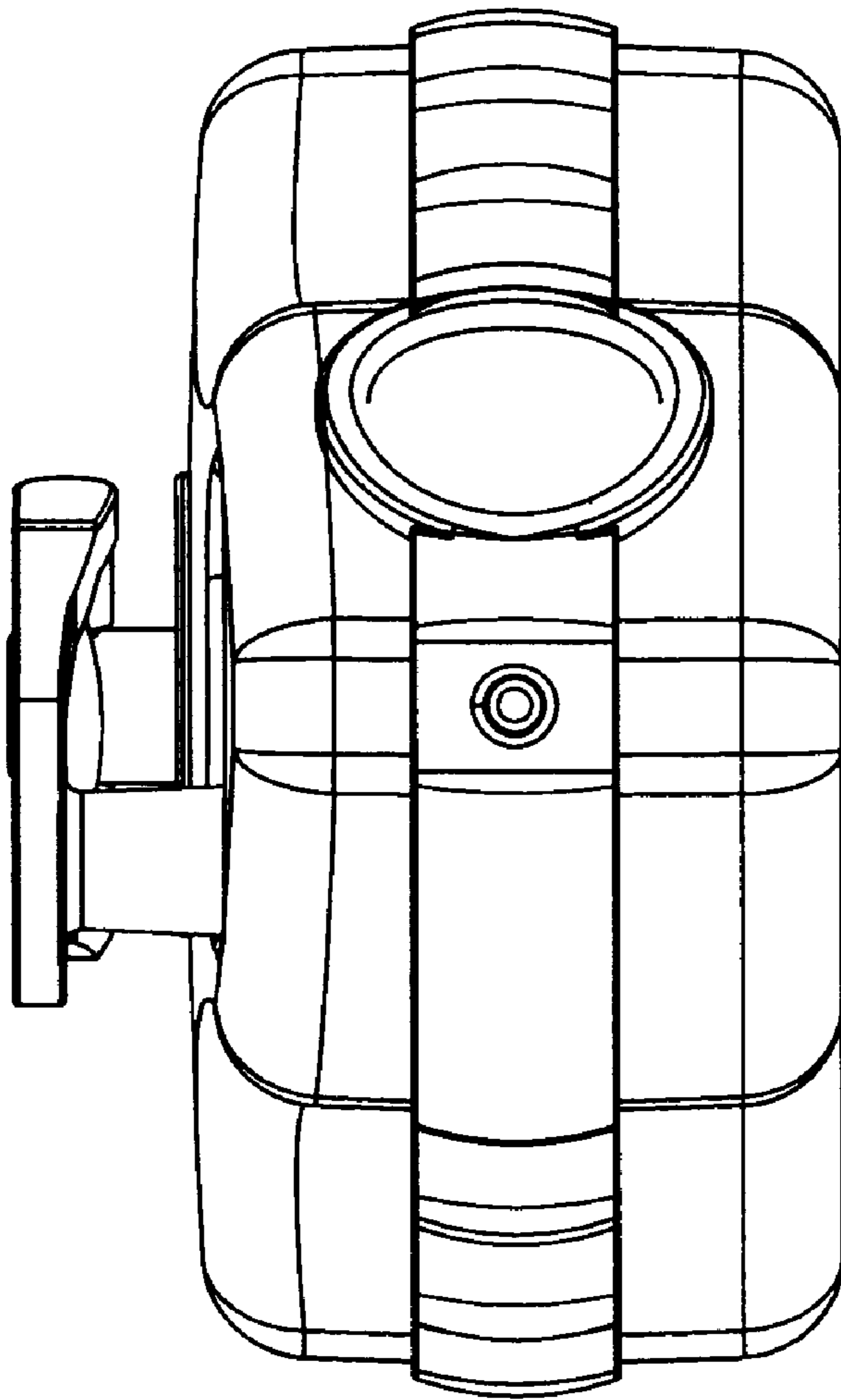

Figure 7

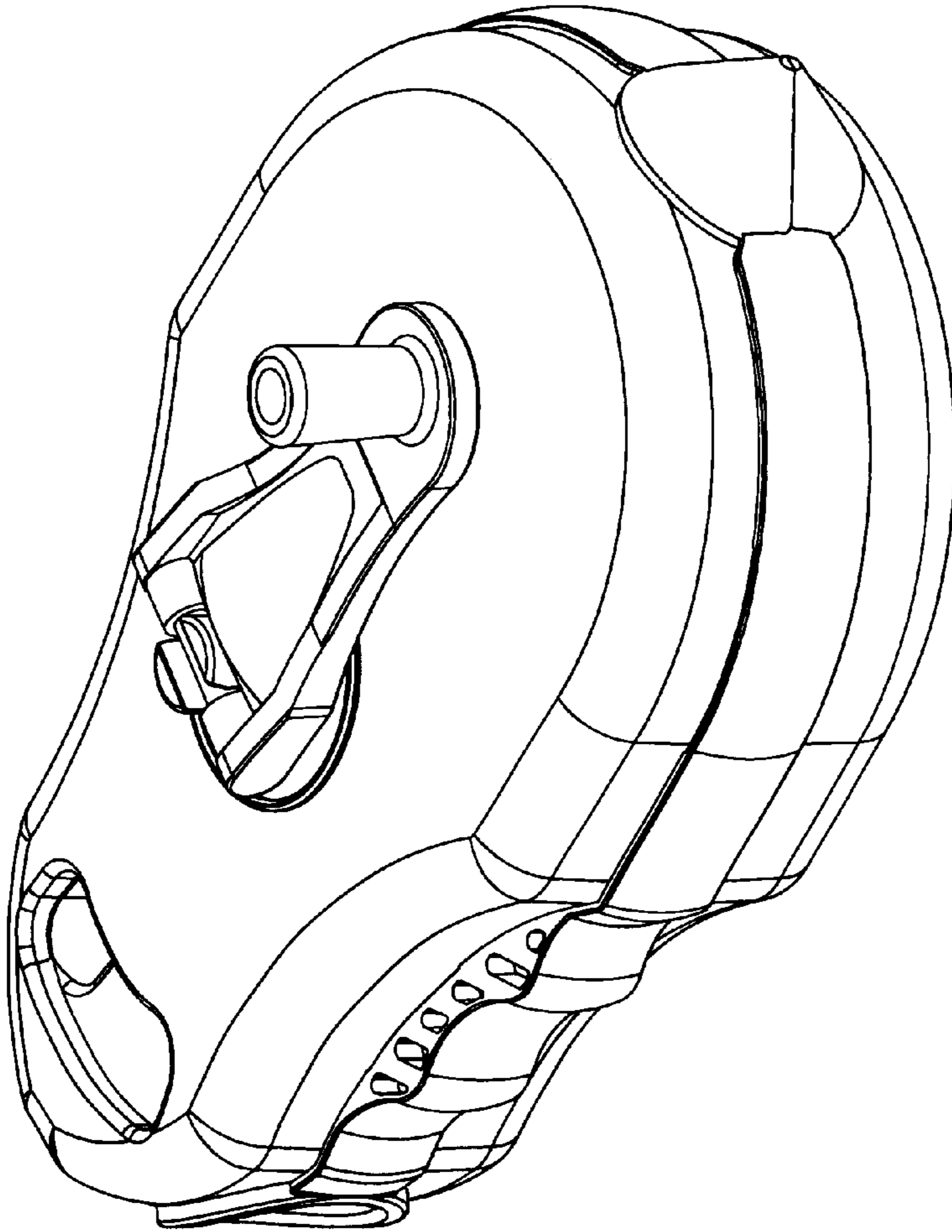

Figure 8