



US00D477671S

(12) **United States Design Patent** (10) **Patent No.:** **US D477,671 S**
Wu (45) **Date of Patent:** **** Jul. 22, 2003**

(54) **BUILDING ELEMENT**

(76) Inventor: **Robert Wu**, No. 16, Yu 6 Road,
Yu-Shih Industrial Park, Tachia,
Taichung Hsien (TW)

(**) Term: **14 Years**

(21) Appl. No.: **29/163,323**

(22) Filed: **Jul. 1, 2002**

(51) **LOC (7) Cl.** **25-02**

(52) **U.S. Cl.** **D25/55**

(58) **Field of Search** D25/55, 136, 135;
52/300, 301, 2.21; 428/28

(56) **References Cited**

U.S. PATENT DOCUMENTS

D419,689 S 1/2000 Wu D25/55

Primary Examiner—Doris Clark

(74) *Attorney, Agent, or Firm*—Alan D. Kamrath; Rider
Bennett, LLP.

(57) **CLAIM**

The ornamental design for building element, as shown and
described.

DESCRIPTION

FIG. 1 is a front elevational view of a building element

showing my new design;

FIG. 2 is a perspective view of a preferred embodiment
utilizing the building element of FIG. 1;

FIG. 3 is a front elevational view of FIG. 2;

FIG. 4 is a top plan view of FIG. 2;

FIG. 5 is a bottom plan view of FIG. 2;

FIG. 6 is a left end elevational view of FIG. 2, the opposite
end being a mirror image thereof, with no claim of orna-
mentation being made for the rear view;

FIG. 7 is a perspective view of another embodiment utilizing
the building element of FIG. 1;

FIG. 8 is a front elevational view of FIG. 7, the left end
elevational view being a mirror image thereof;

FIG. 9 is a top plan view of FIG. 7;

FIG. 10 is a bottom plan view of FIG. 7; and,

FIG. 11 is a right end elevational view of FIG. 7; the rear
elevation being a mirror image thereof.

1 Claim, 4 Drawing Sheets

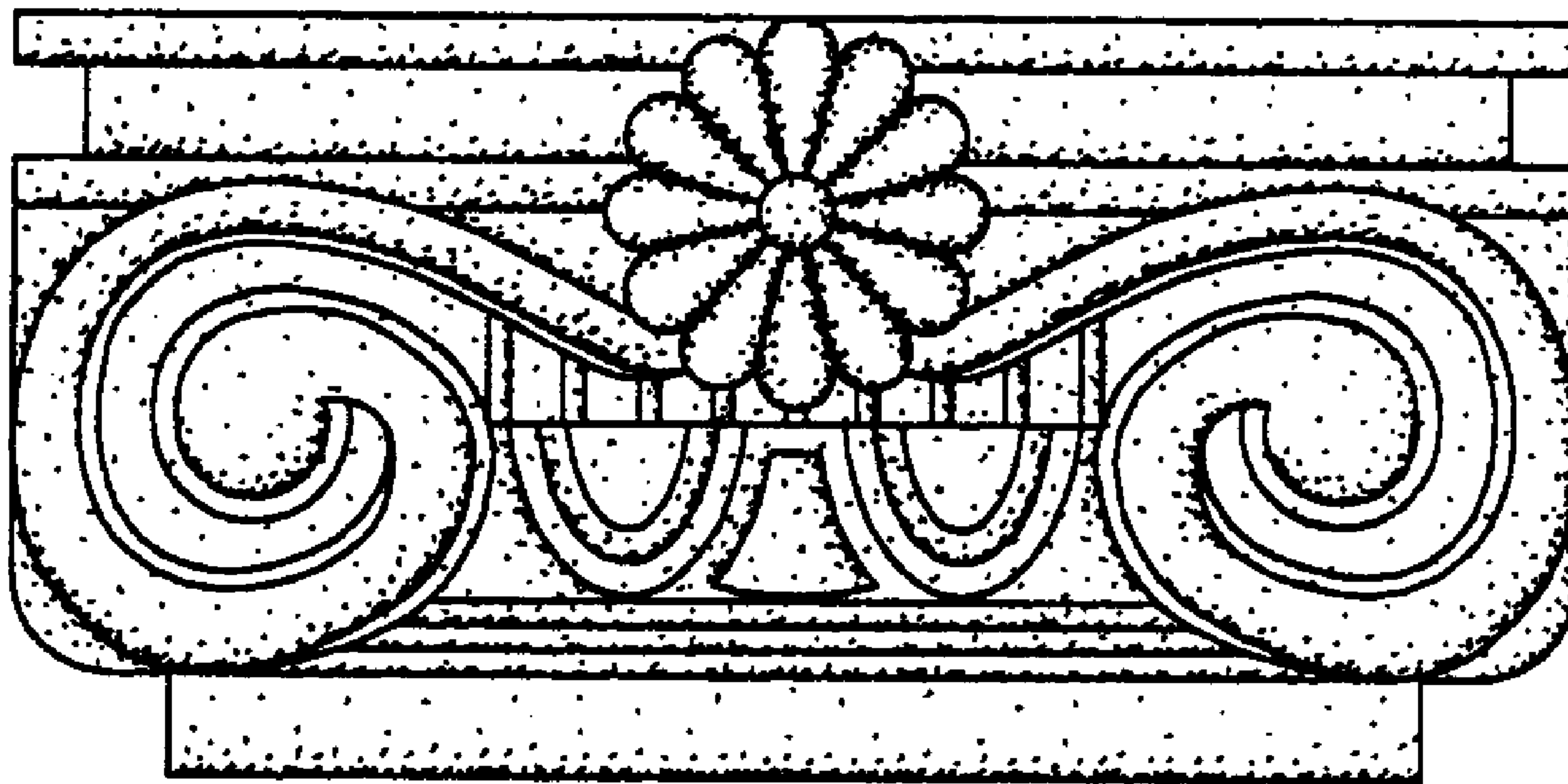

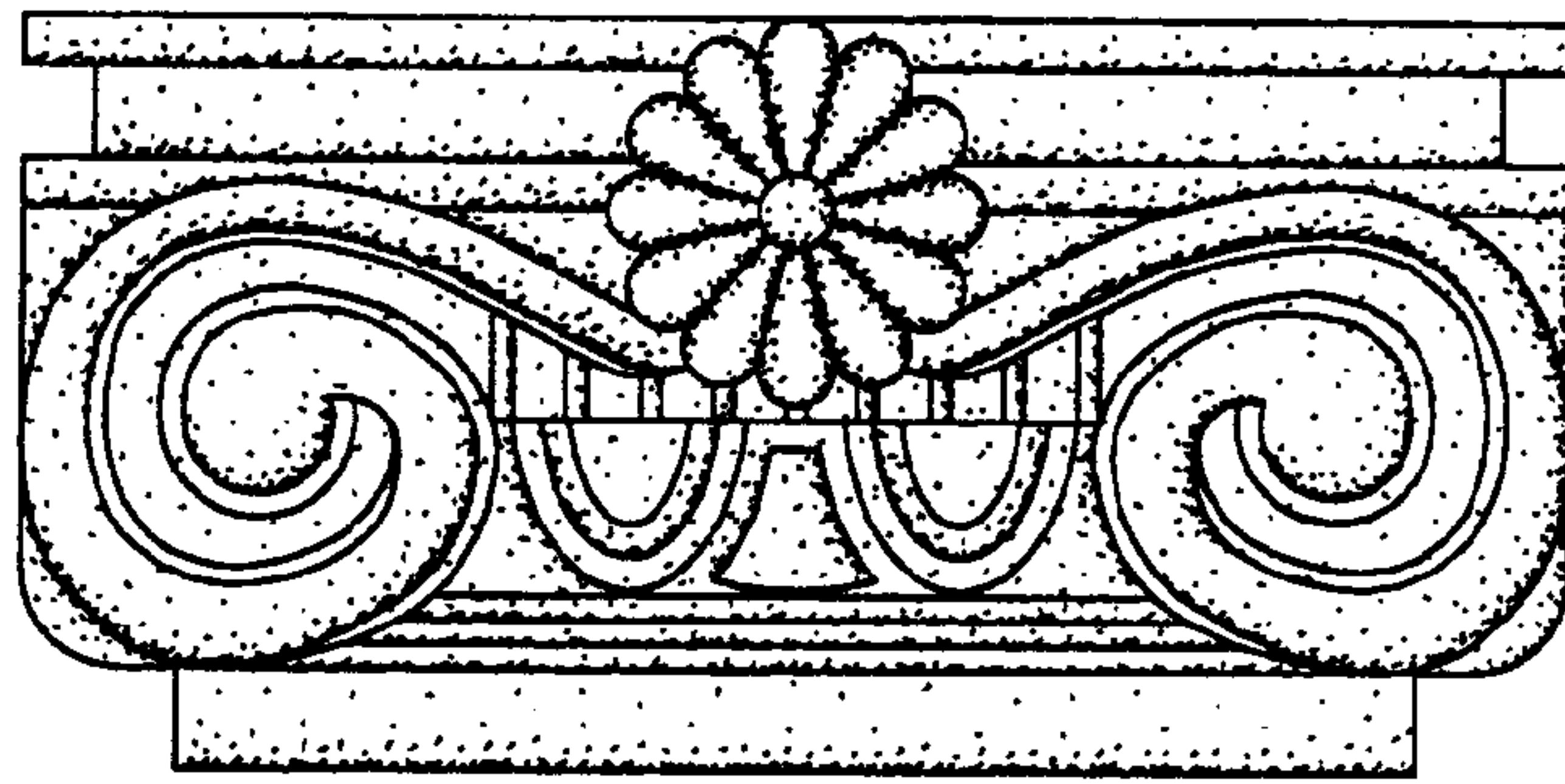

Fig. 1

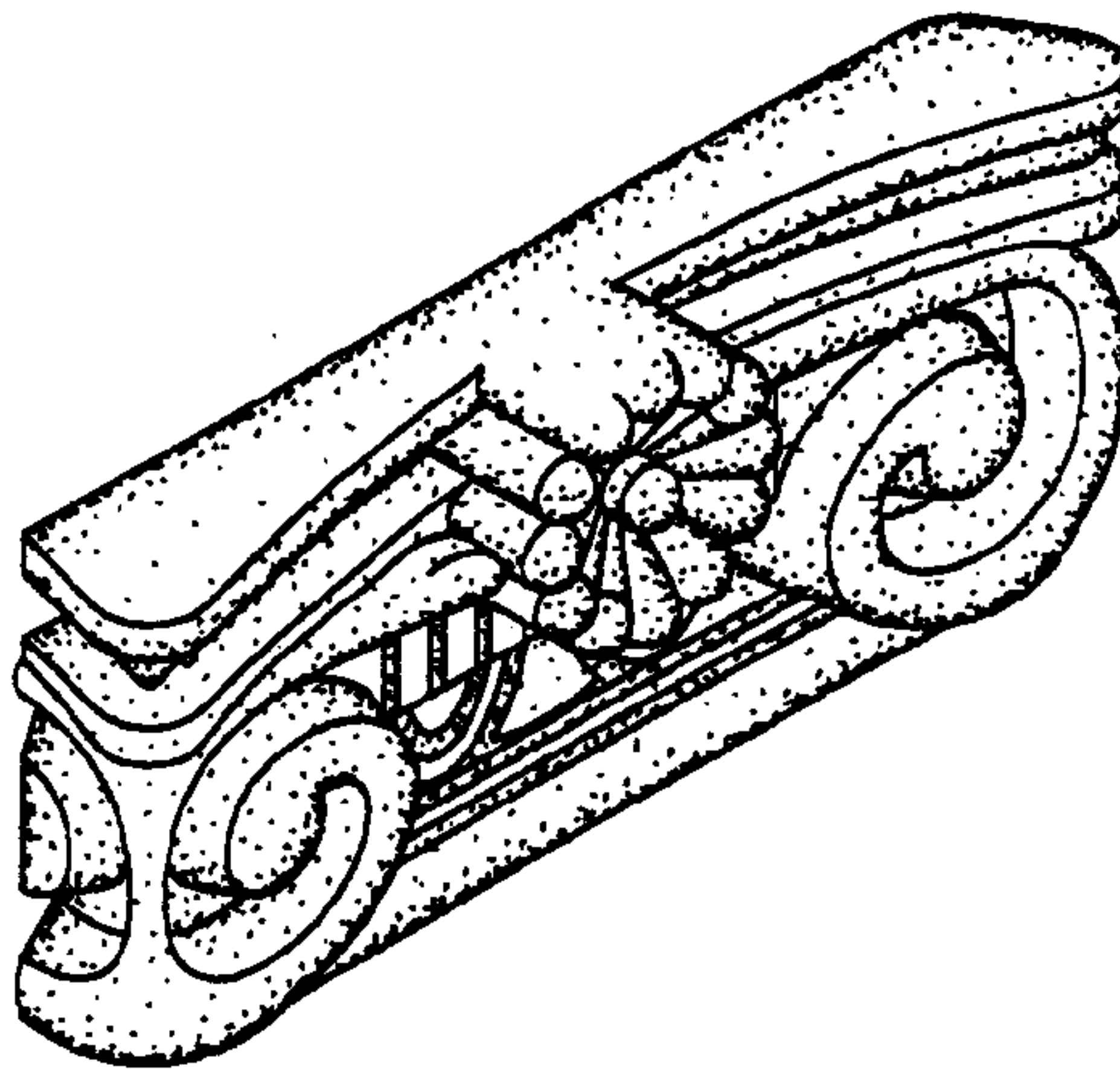

Fig. 2

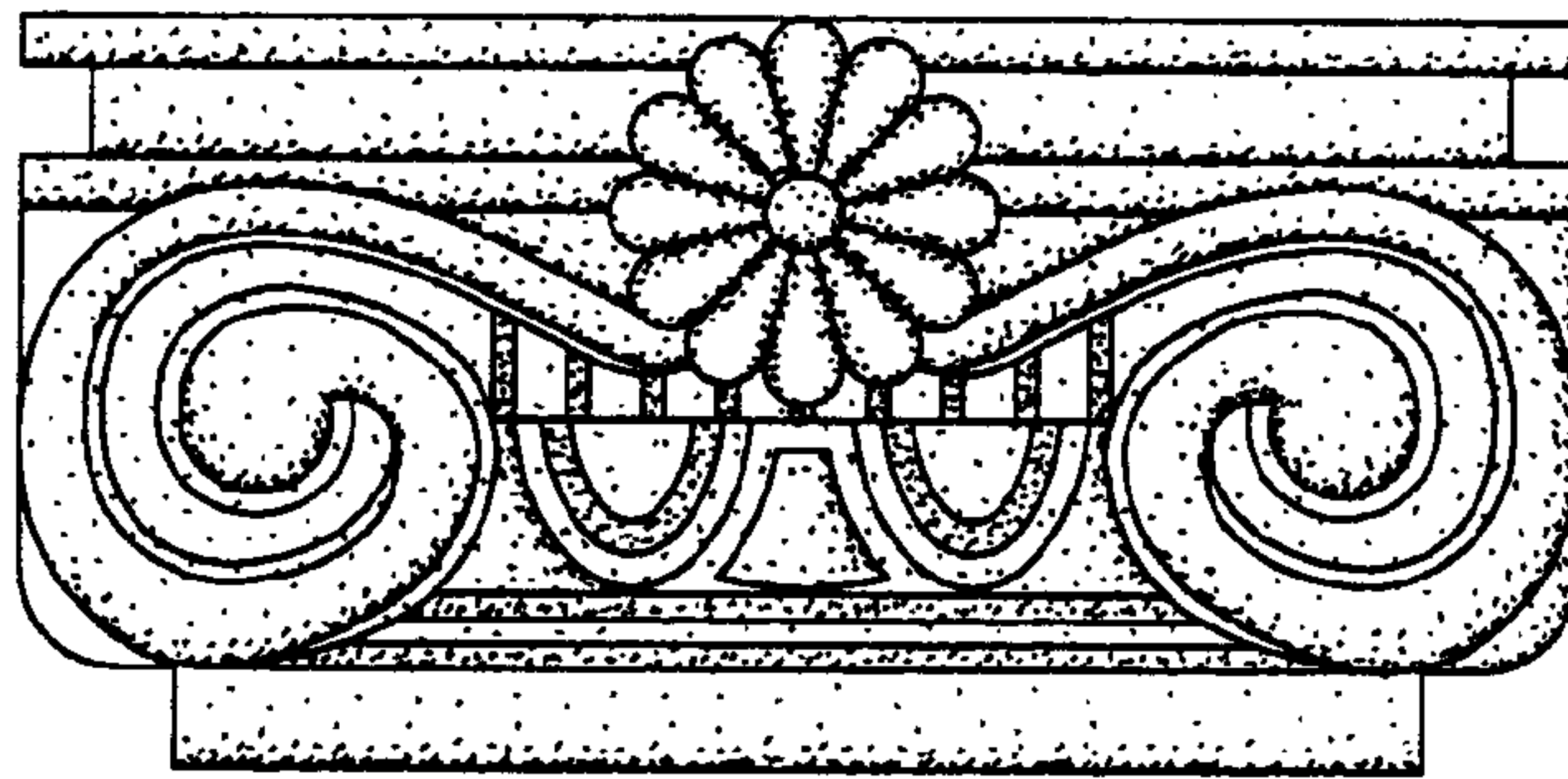

Fig. 3

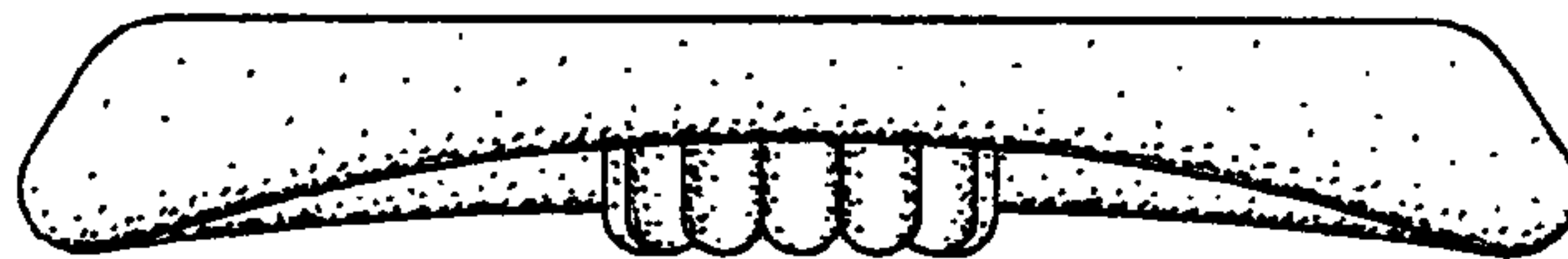

Fig. 4

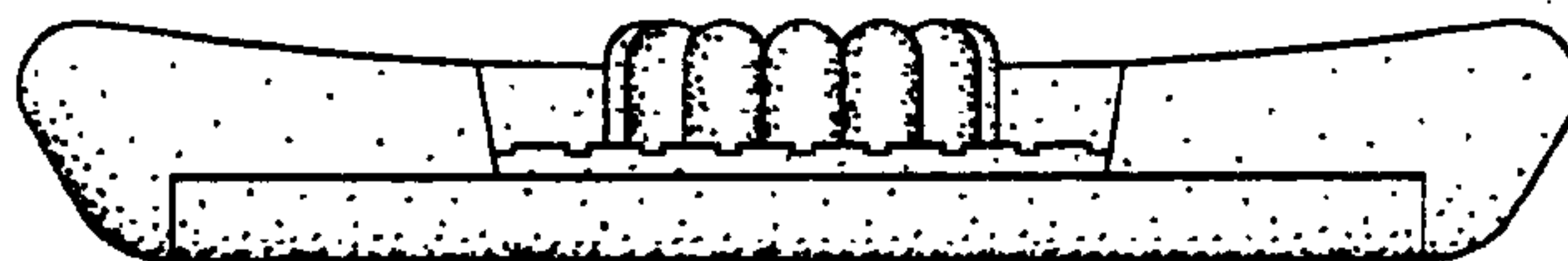

Fig. 5



Fig. 6

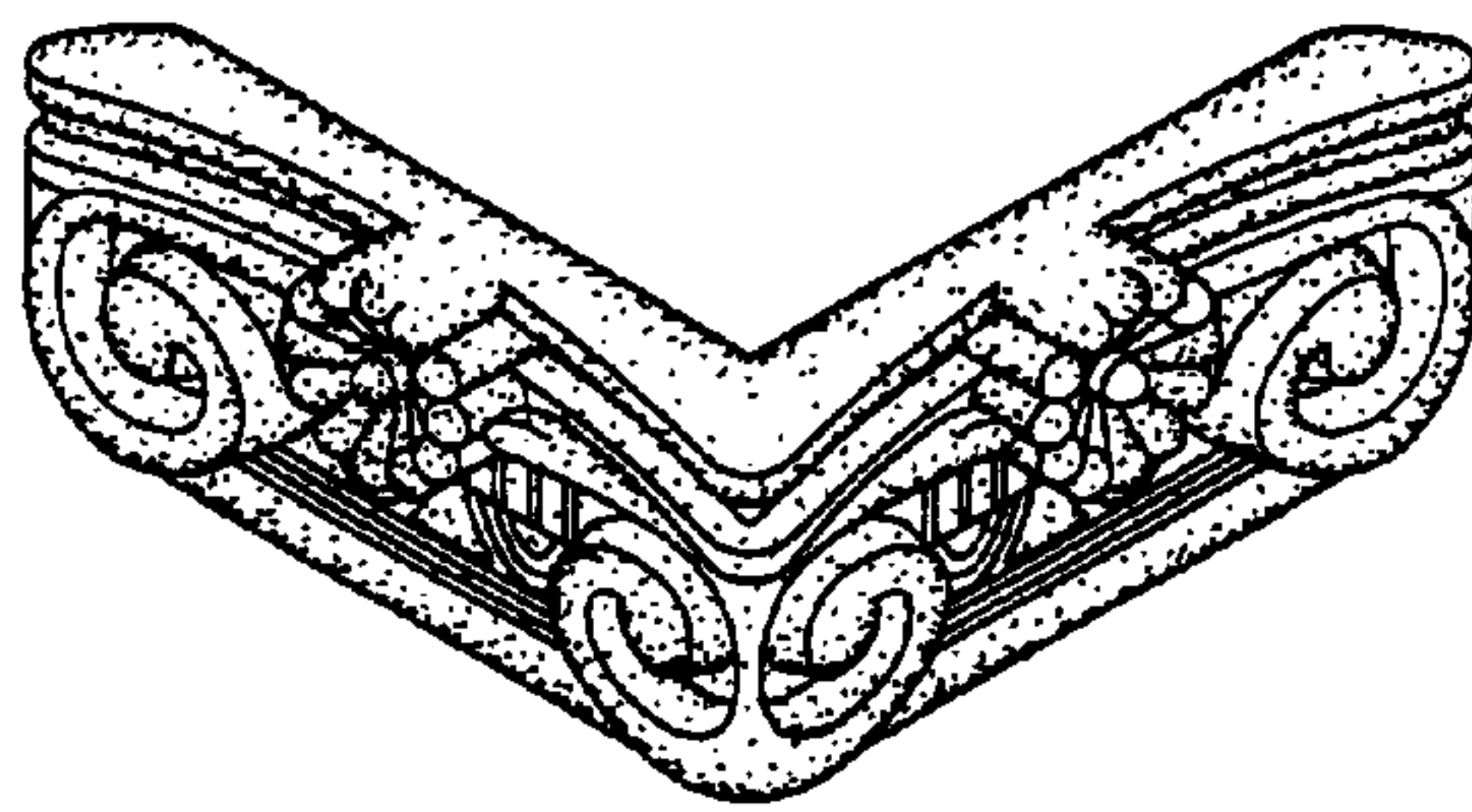

Fig. 7

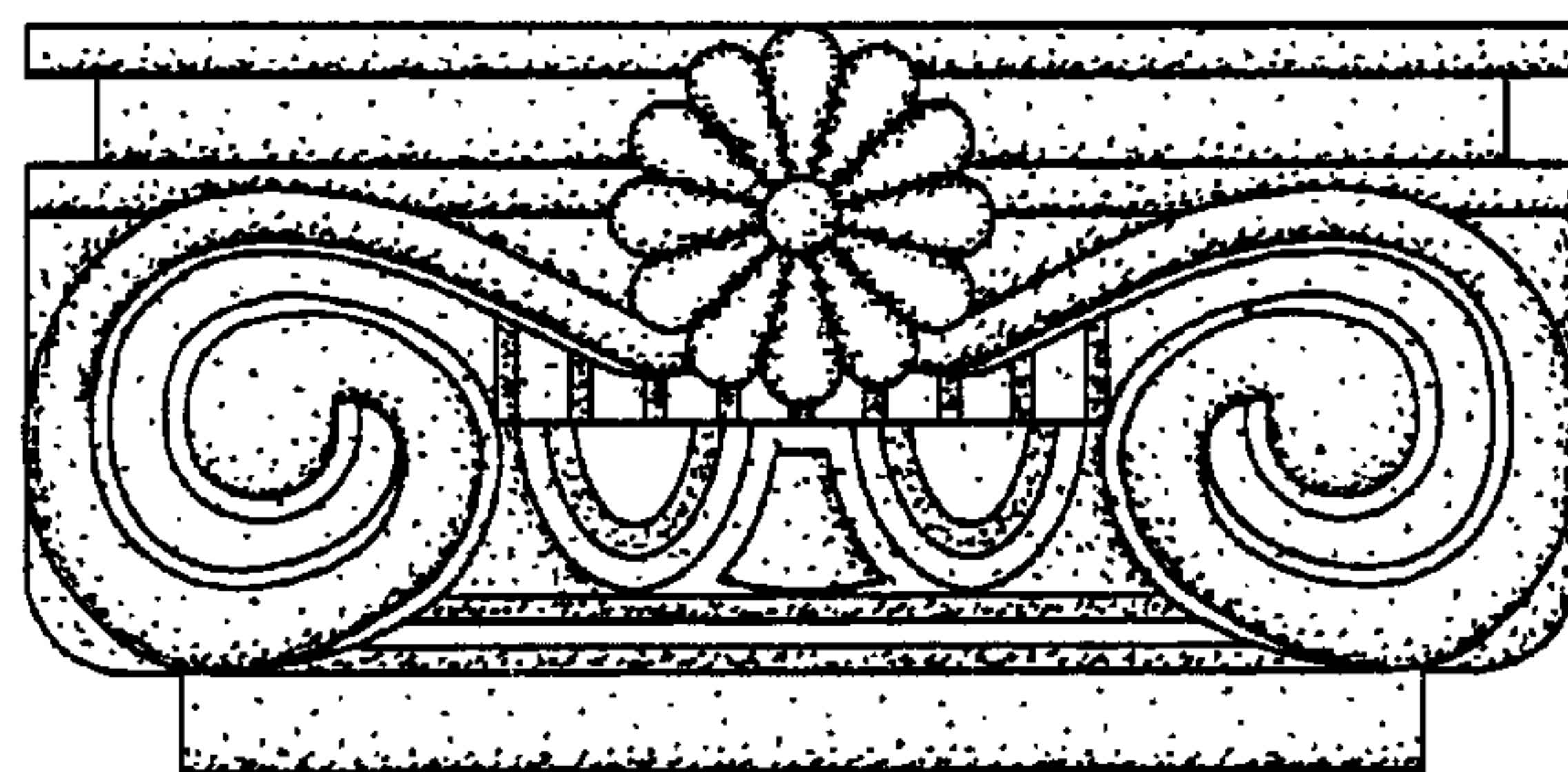

Fig. 8

Fig. 9

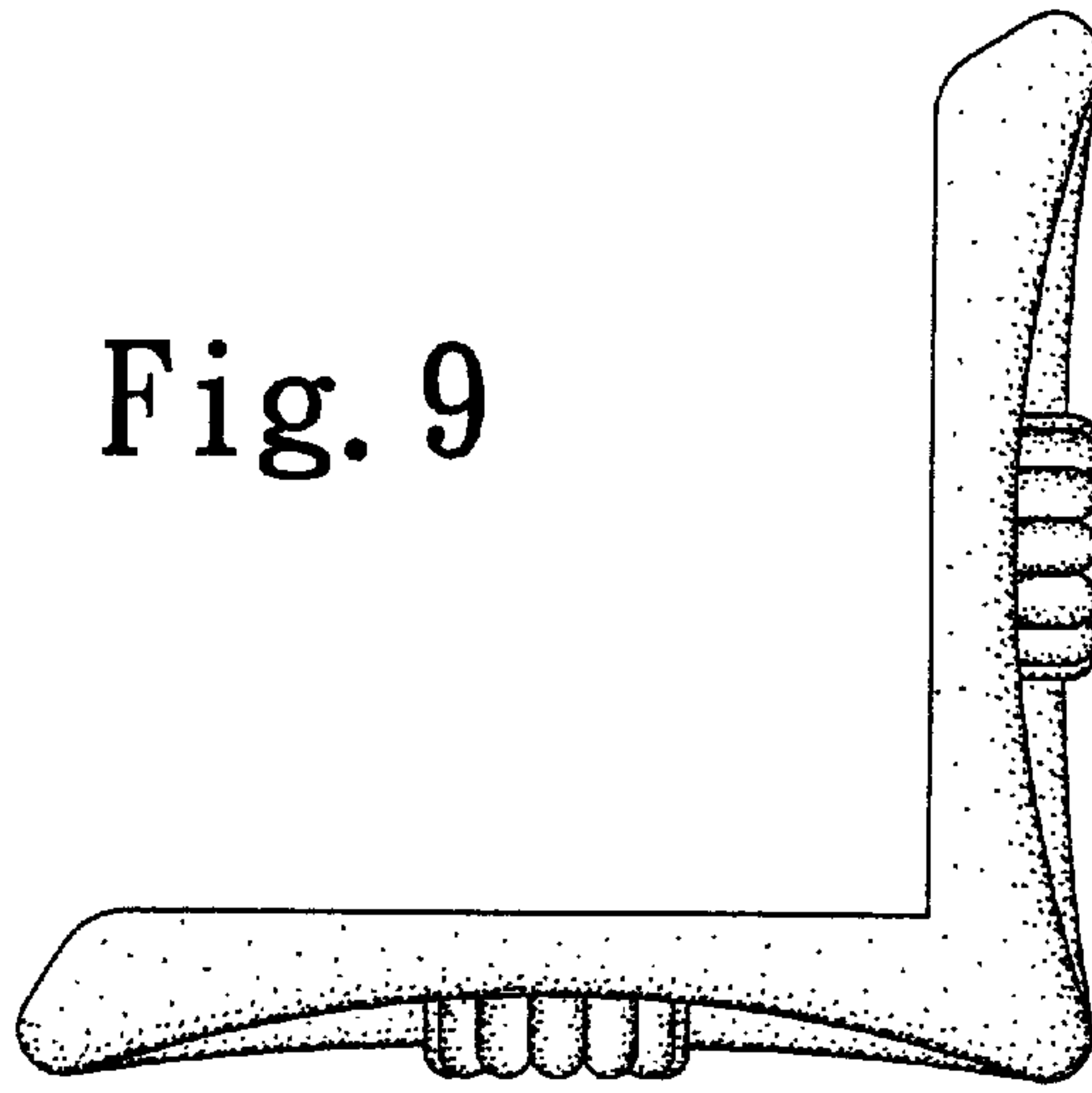

Fig. 10

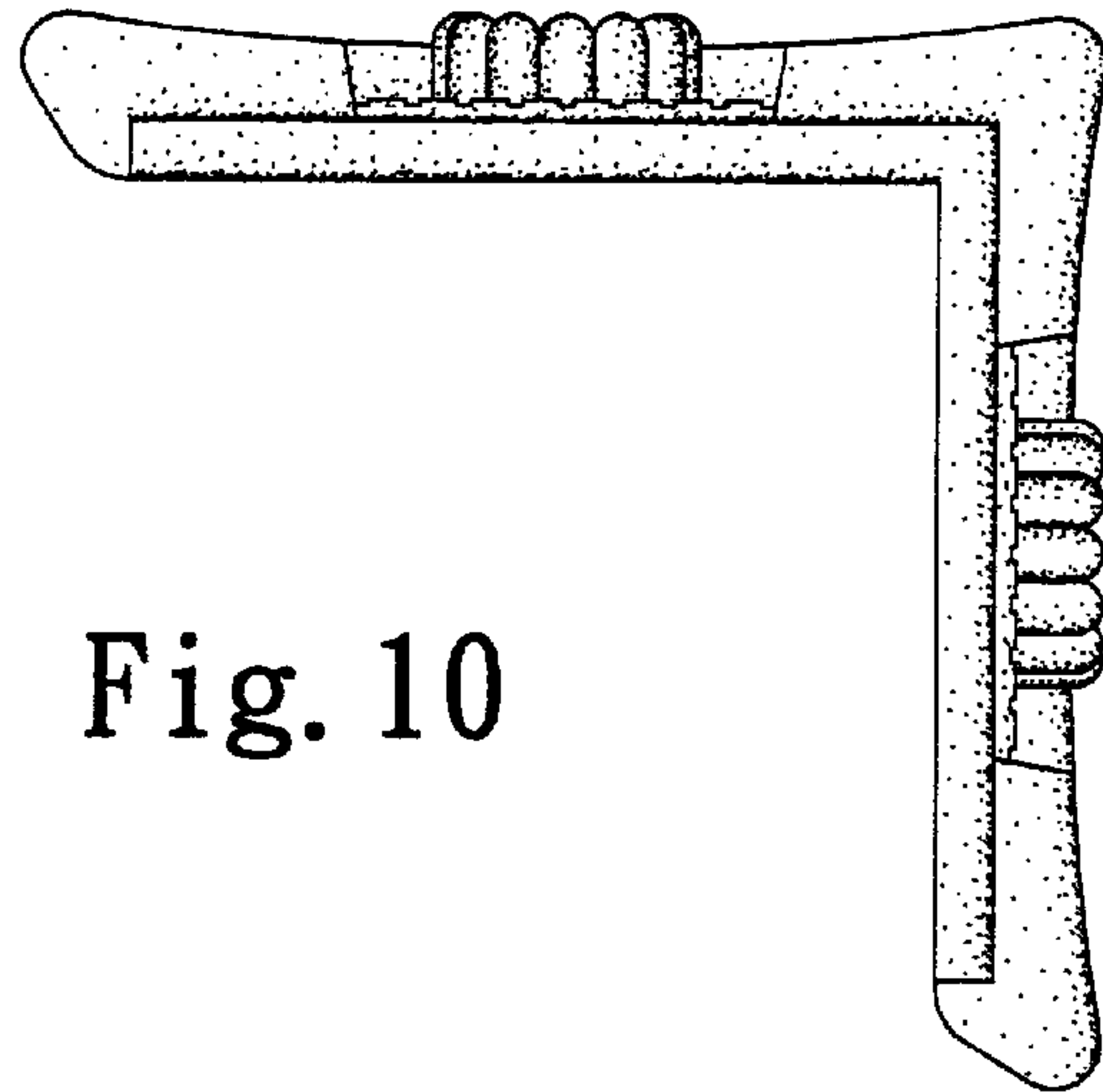

Fig. 11

