



US00D477593S

(12) **United States Design Patent**
Komiyama

(10) **Patent No.:** **US D477,593 S**

(45) **Date of Patent:** **** Jul. 22, 2003**

(54) **HEADPHONE**

(75) Inventor: **Jun Komiyama**, Tokyo (JP)

(73) Assignee: **Sony Corporation**, Tokyo (JP)

(**) Term: **14 Years**

(21) Appl. No.: **29/170,043**

(22) Filed: **Oct. 31, 2002**

(51) **LOC (7) Cl.** **14-01**

(52) **U.S. Cl.** **D14/223**

(58) **Field of Search** D14/192, 205,
D14/206, 223; 181/129, 130; 381/381,
374, 376, 377, 378, 379, 375; D24/174;
379/430

(56) **References Cited**

U.S. PATENT DOCUMENTS

4,585,089	A	*	4/1986	Topholm	181/130	X
5,450,496	A	*	9/1995	Burris et al.	381/381	X
D383,757	S	*	9/1997	Dobrusskin et al.	D14/223	
D443,261	S		6/2001	Yuyama			
D462,944	S	*	9/2002	Yuen	D14/206	
D463,791	S	*	10/2002	Nagai et al.	D14/223	
D464,638	S	*	10/2002	Huang	D14/205	
D468,728	S	*	1/2003	Rath et al.	D14/223	

OTHER PUBLICATIONS

Catalog, "Value Up" pp. 2, 24, Front and Back Covers, Sony Corporation (Jan. 2002).

Webpage, "HP-AL52," [www://www.jvc-victor.co.jp/accessory/headphone/be/al52_02.html](http://www.jvc-victor.co.jp/accessory/headphone/be/al52_02.html), 1sheet, JVC-Victor (Jul. 2002).

* cited by examiner

Primary Examiner—Paula A. Mortimer

(74) *Attorney, Agent, or Firm*—Rader, Fishman & Grauer PLLC

(57) **CLAIM**

The ornamental design for a headphone, as shown.

DESCRIPTION

FIG. 1 is a perspective view of a headphone showing my new design;

FIG. 2 is a front elevational view thereof;

FIG. 3 is a rear elevational view thereof;

FIG. 4 is a left side elevational view thereof;

FIG. 5 is a right side elevational view thereof;

FIG. 6 is a top plan view thereof; and,

FIG. 7 is a bottom plan view thereof.

1 Claim, 4 Drawing Sheets

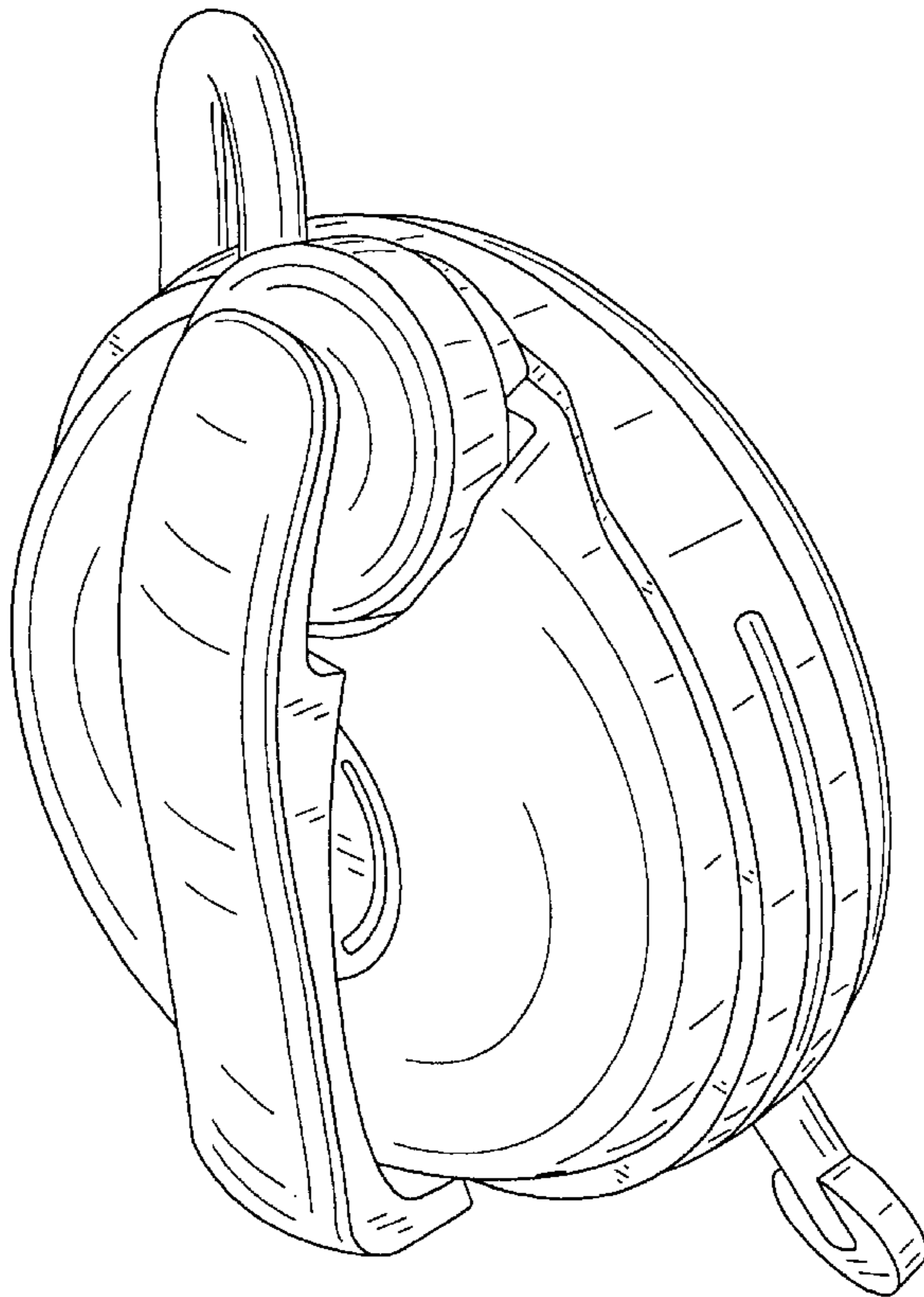

FIG. 1

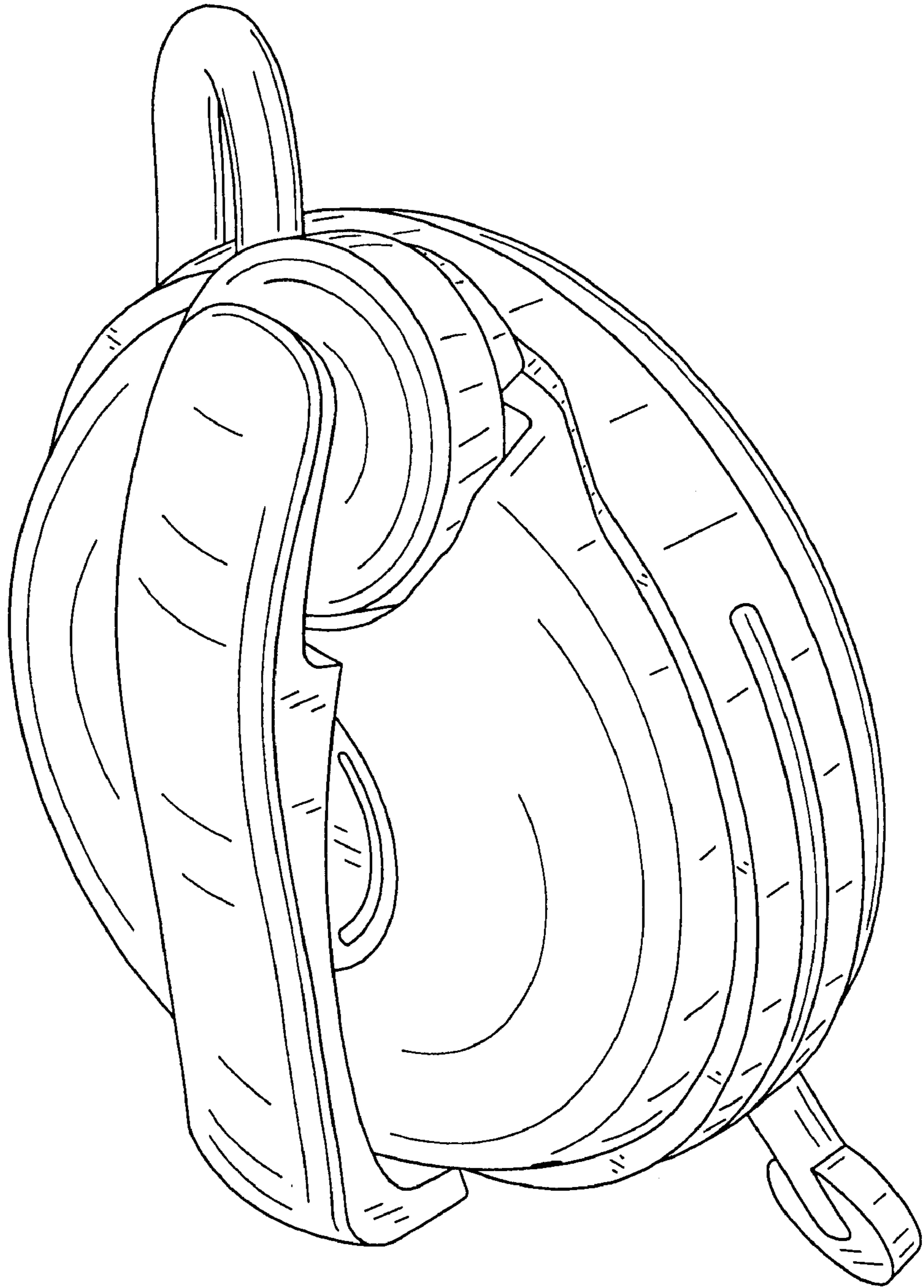

FIG. 2

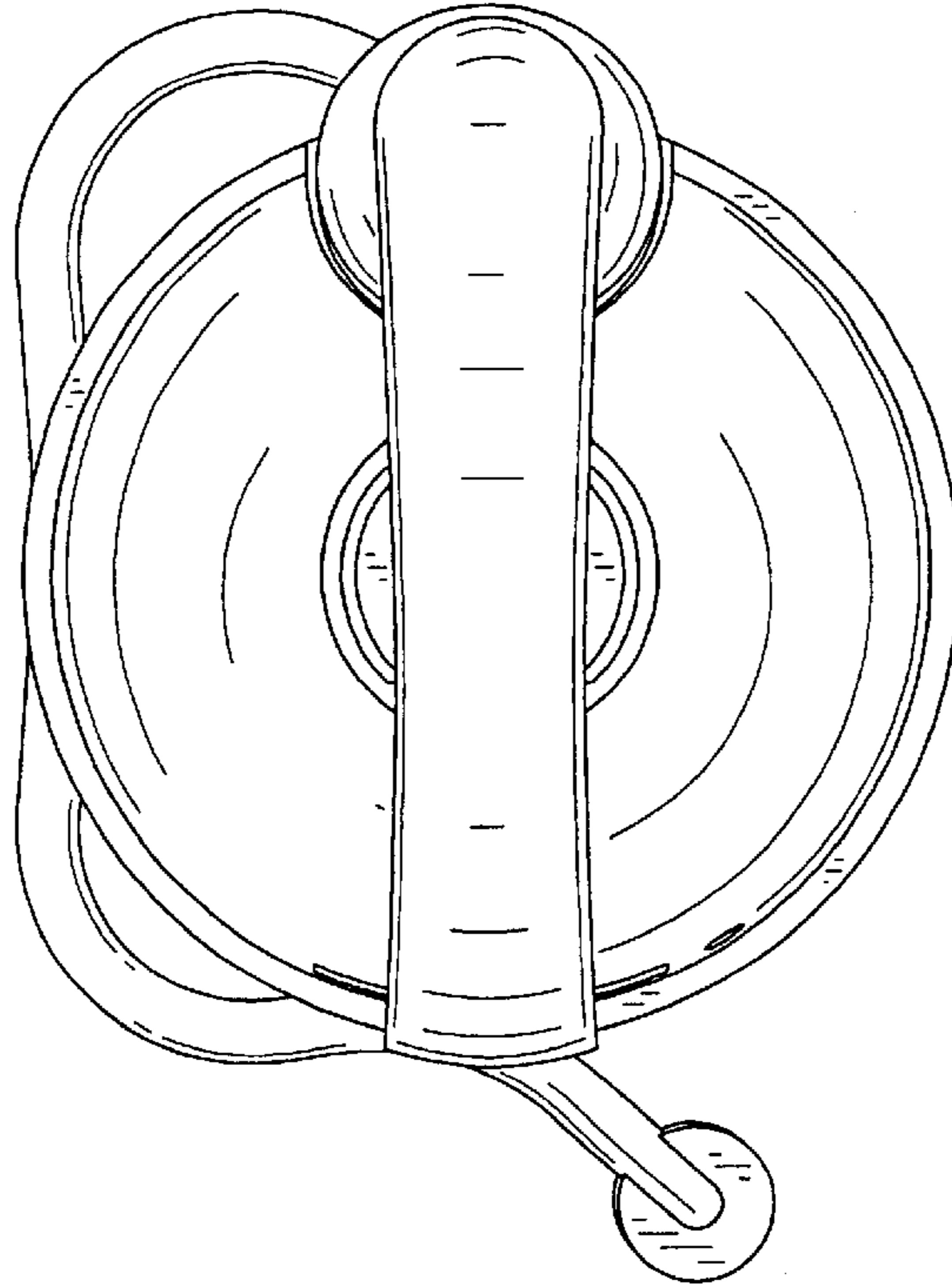

FIG. 3

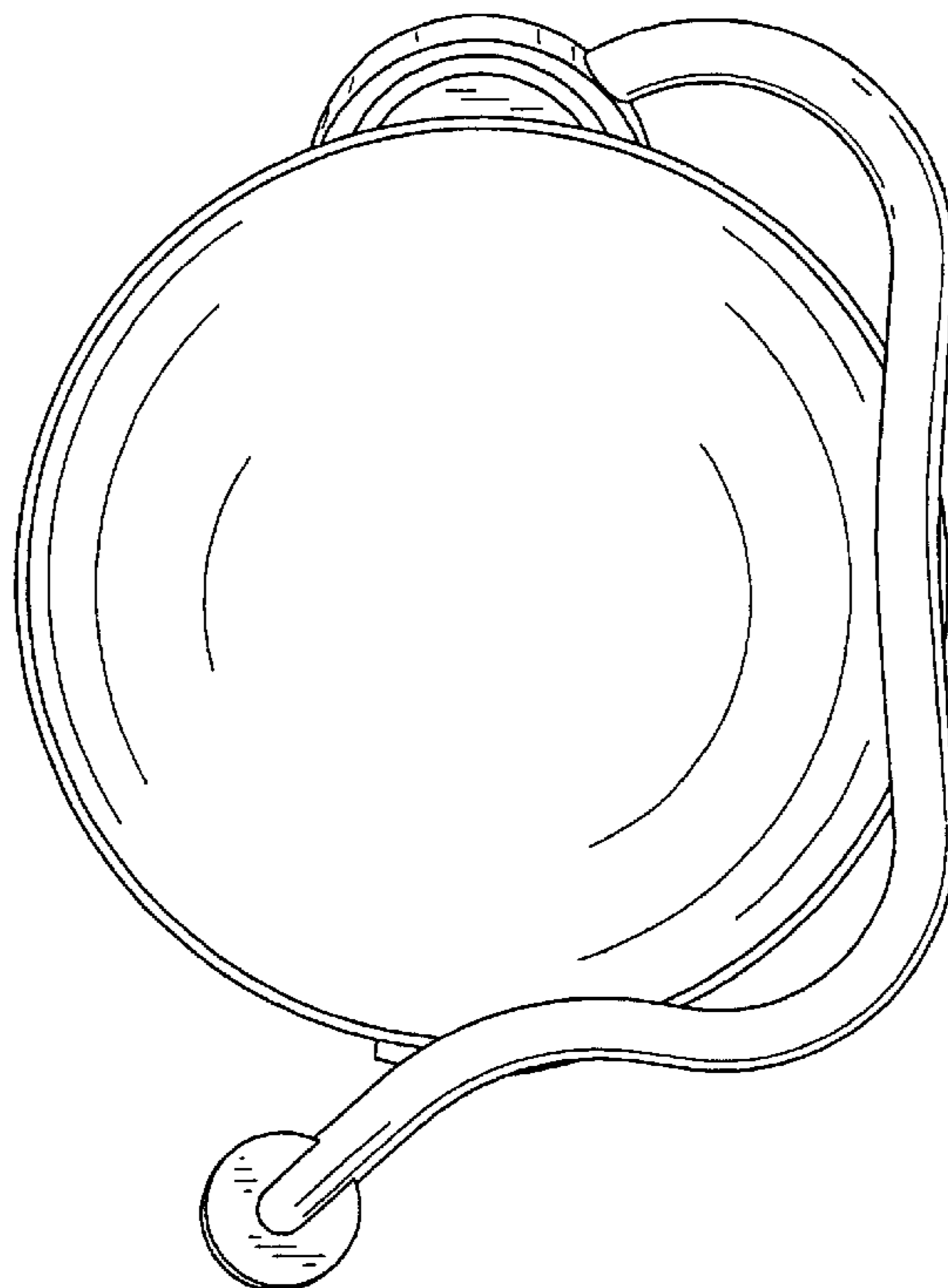

FIG. 4

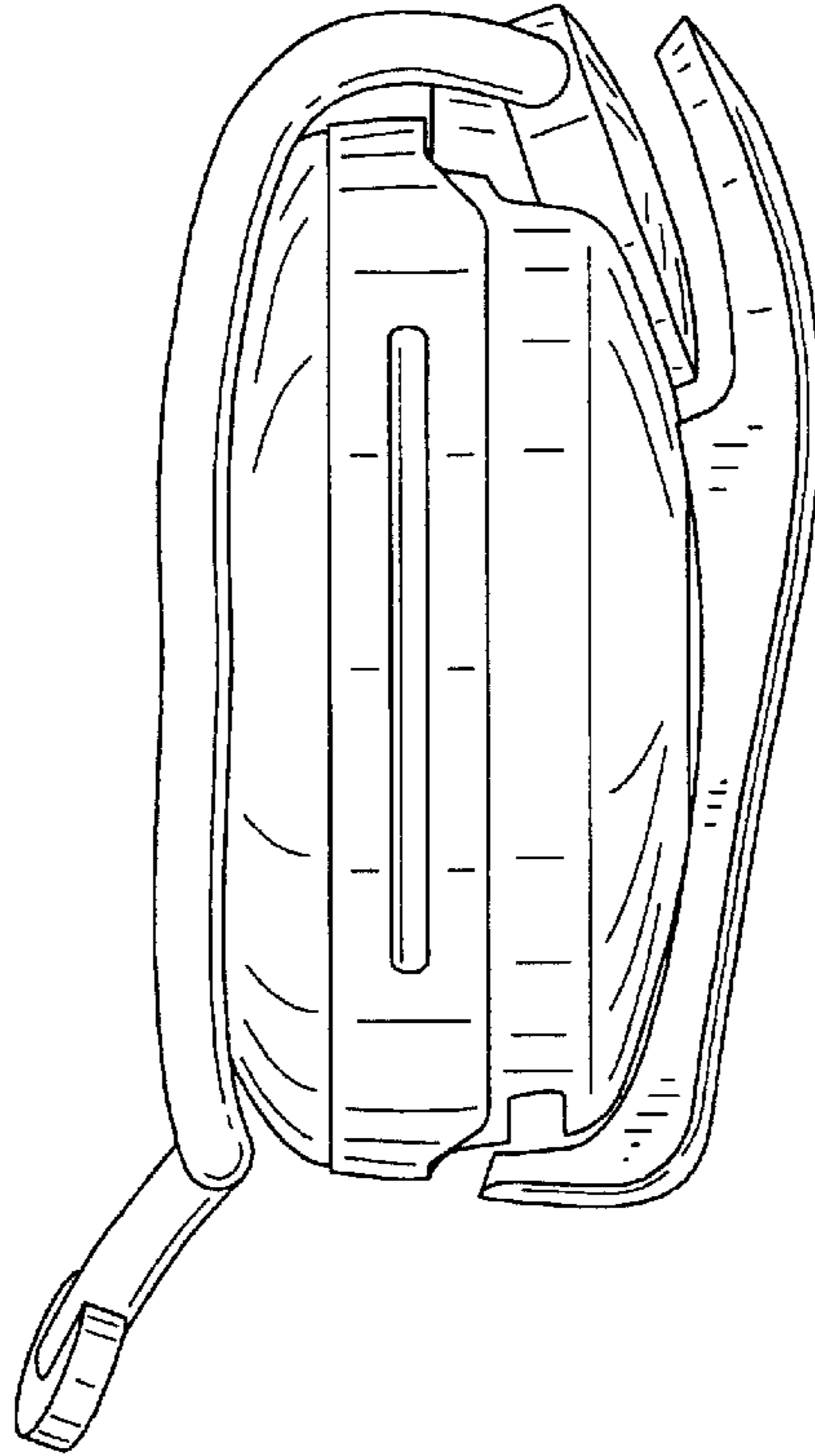

FIG. 5

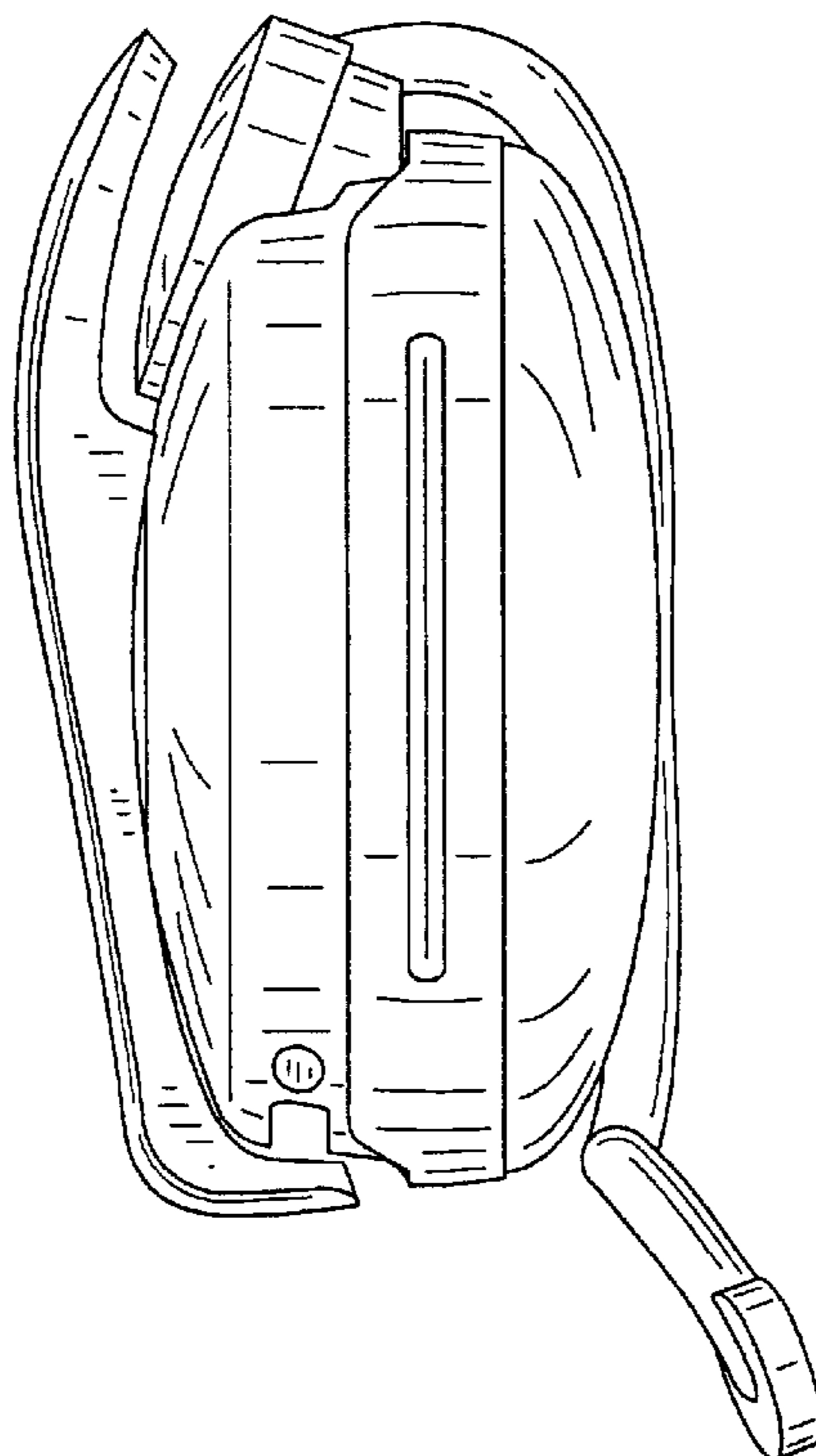

FIG. 6

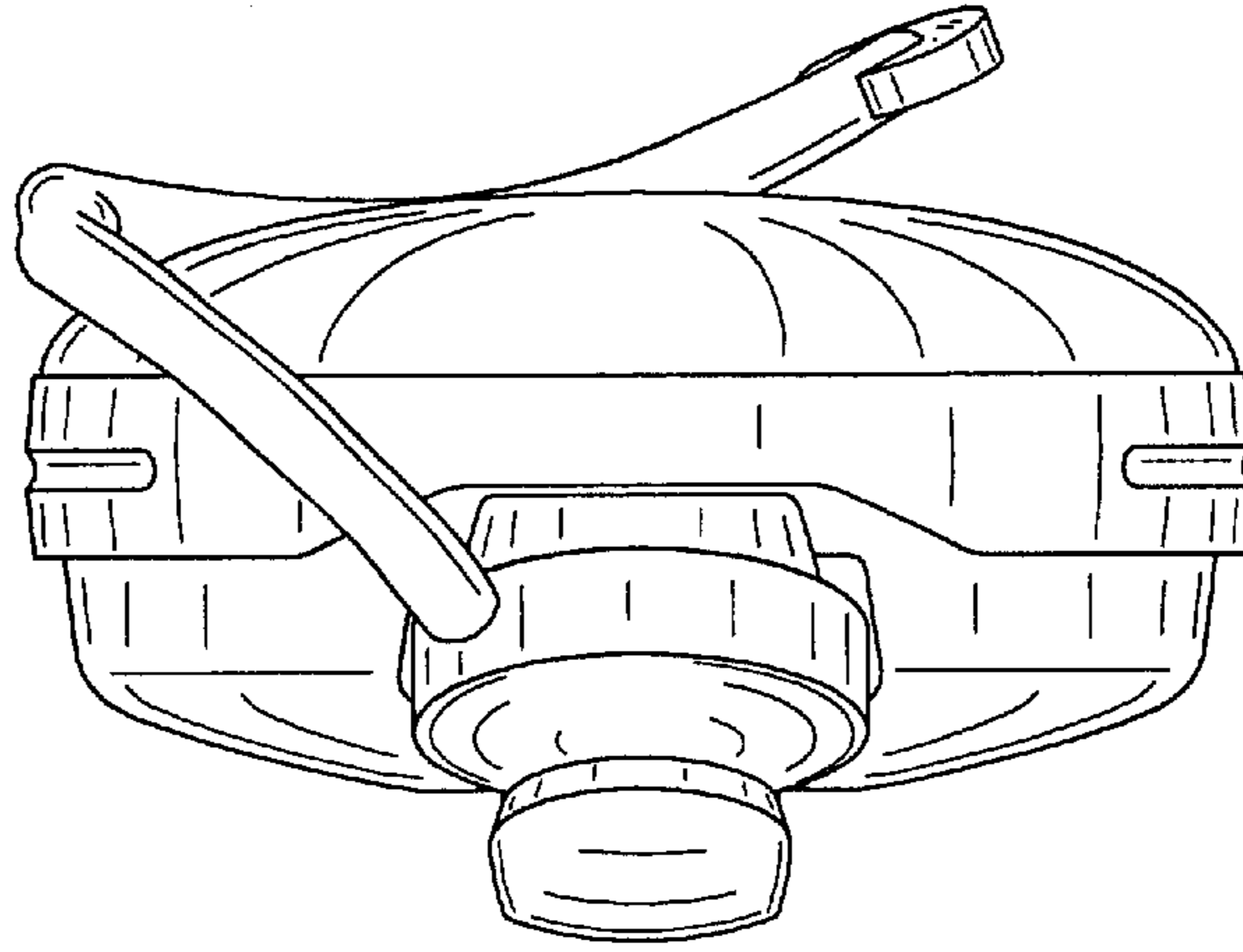

FIG. 7

