



US00D477502S

(12) **United States Design Patent**
Spalding et al.

(10) **Patent No.:** **US D477,502 S**

(45) **Date of Patent:** **** Jul. 22, 2003**

(54) **JUICER**

(75) Inventors: **Jerry E. Spalding**, Dallas County, TX (US); **Jay B. Spalding**, Dallas County, TX (US)

(73) Assignee: **U.S. Jesco International, Ltd., Inc.**, Carrollton, TX (US)

(**) Term: **14 Years**

(21) Appl. No.: **29/164,304**

(22) Filed: **Jul. 22, 2002**

(51) **LOC (7) Cl.** **31-00**

(52) **U.S. Cl.** **D7/665**

(58) **Field of Search** D7/665, 666, 372-374, D7/381, 384; 99/495, 501-508; 100/110, 125, 131-135, 213, 282

(56) **References Cited**

U.S. PATENT DOCUMENTS

1,894,858 A * 1/1933 Fromm 99/503
D229,368 S * 11/1973 Marris D7/665

* cited by examiner

Primary Examiner—Terry A. Wallace
(74) *Attorney, Agent, or Firm*—Harry C. Post, III

(57) **CLAIM**

We claim the ornamental design for a juicer, substantially as shown and described.

DESCRIPTION

FIG. 1 is an elevation view directed toward the front of a juicer;

FIG. 2 is a plan view directed toward the top of a juicer shown in FIG. 1;

FIG. 3 is an elevation view directed toward the back of the juicer shown in FIG. 1;

FIG. 4 is a plan view directed toward the bottom of the juicer shown in FIG. 1;

FIG. 5 is an elevation view directed toward the left side of the juicer shown in FIG. 1; and,

FIG. 6 is an elevation view directed toward the right side of the juicer shown in FIG. 1.

1 Claim, 3 Drawing Sheets

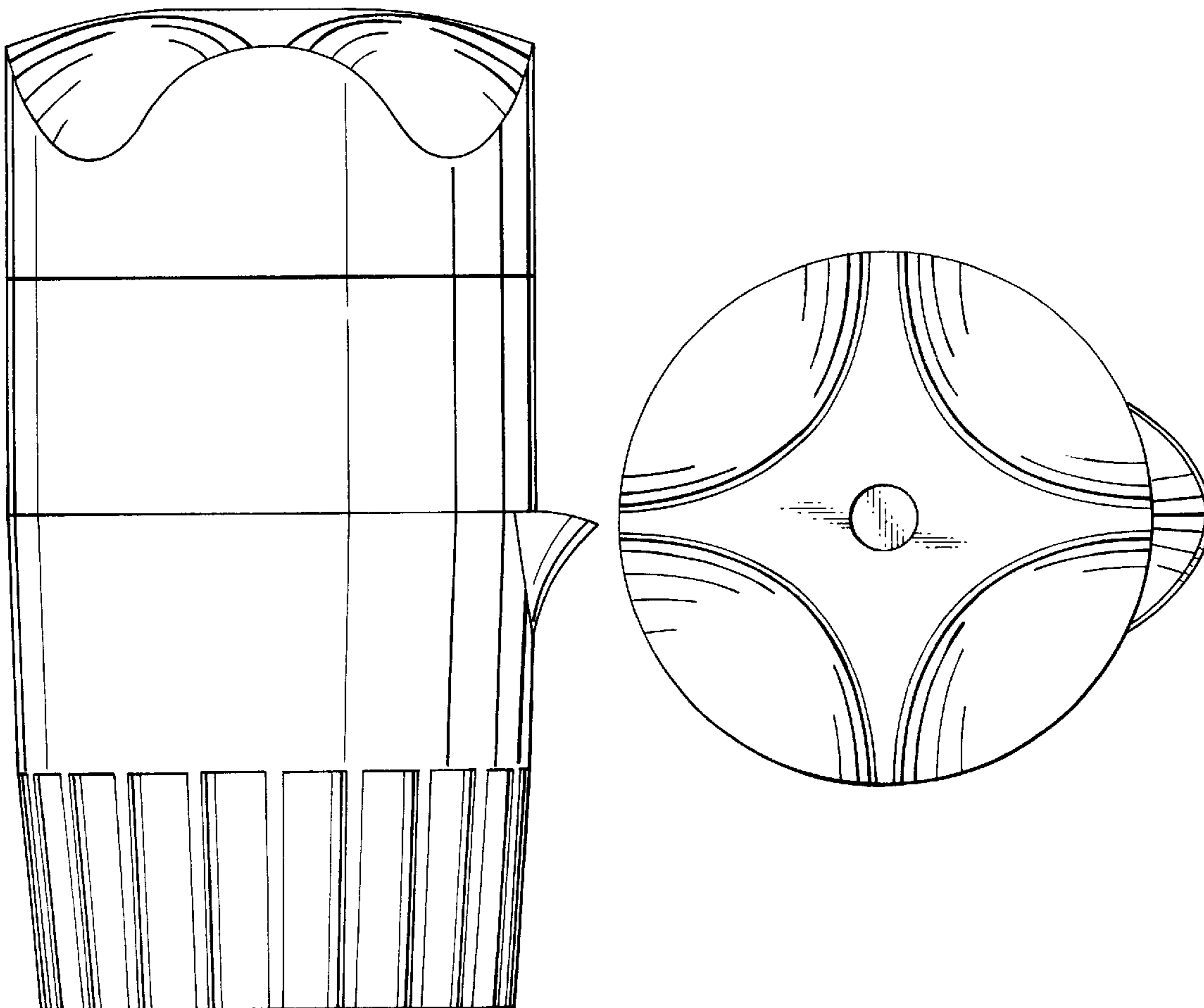

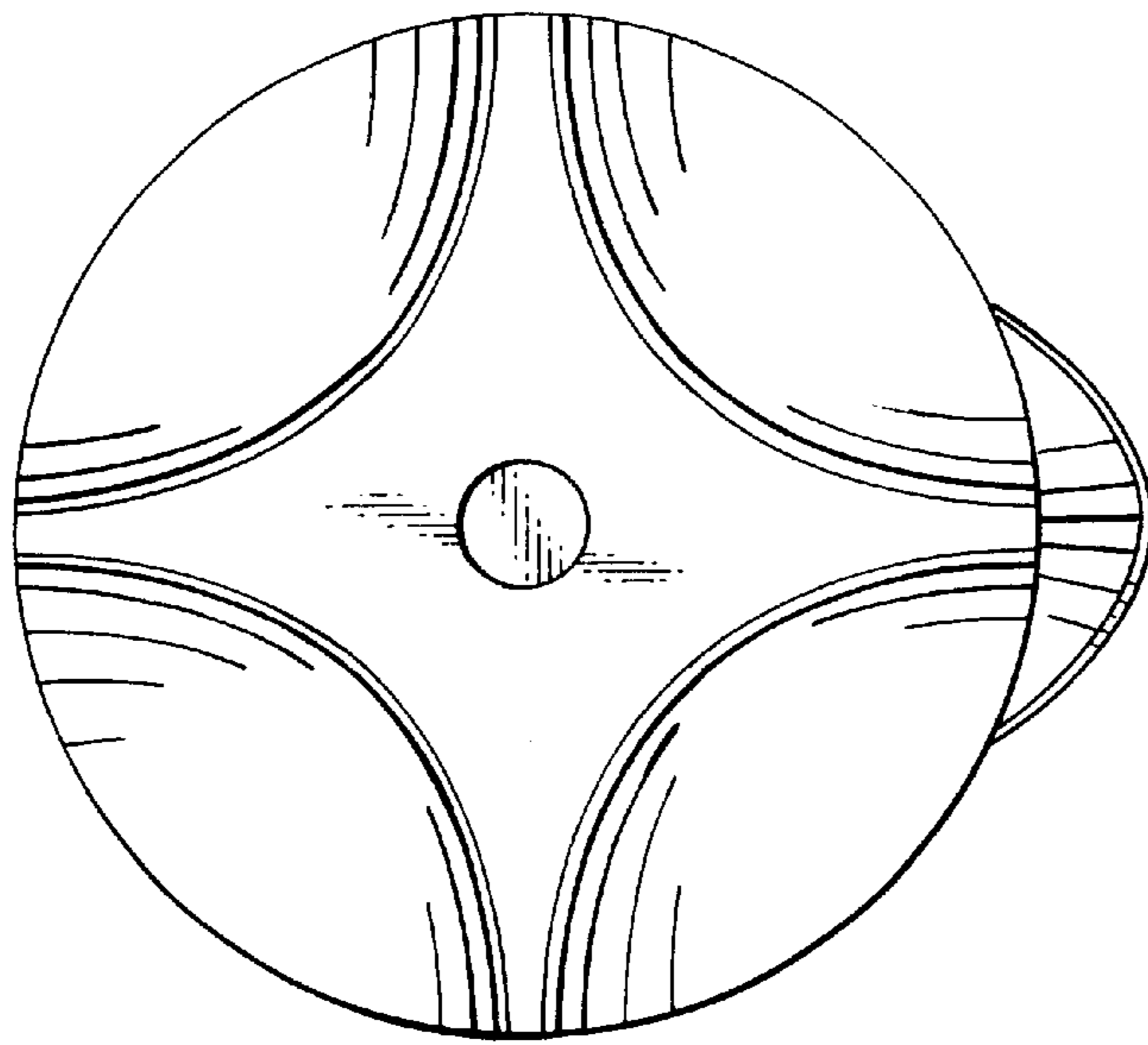

Fig. 2

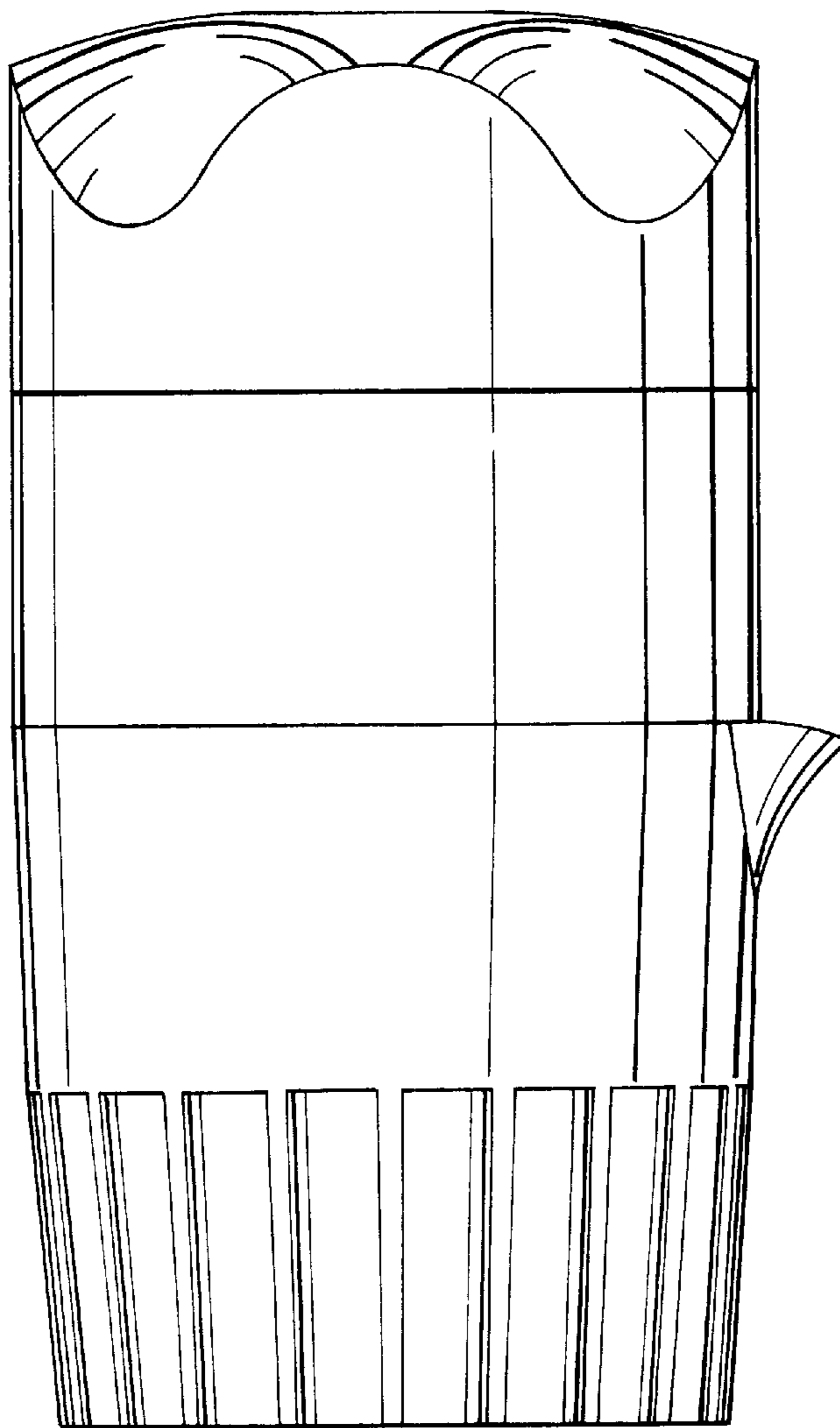

Fig. 1

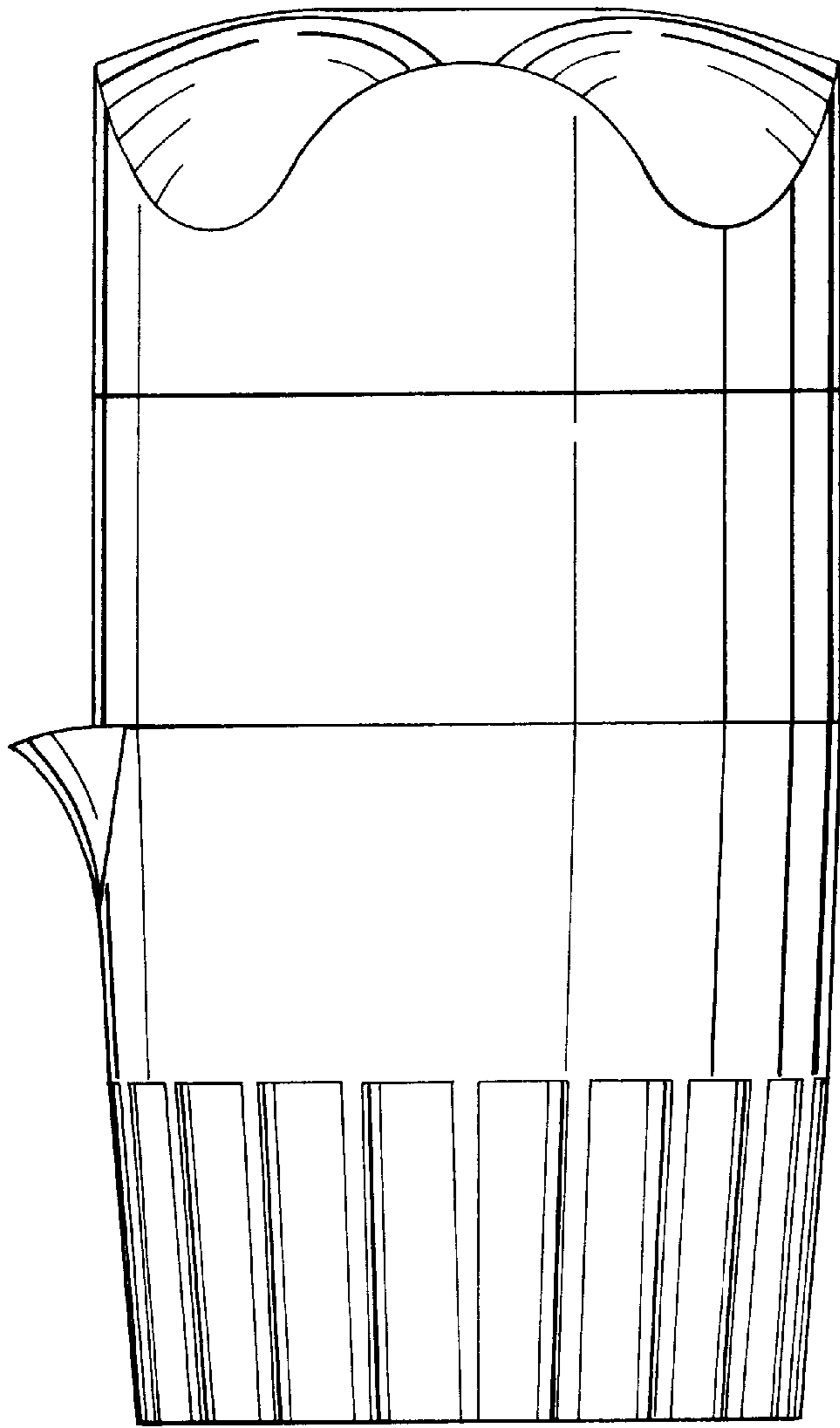

Fig. 3

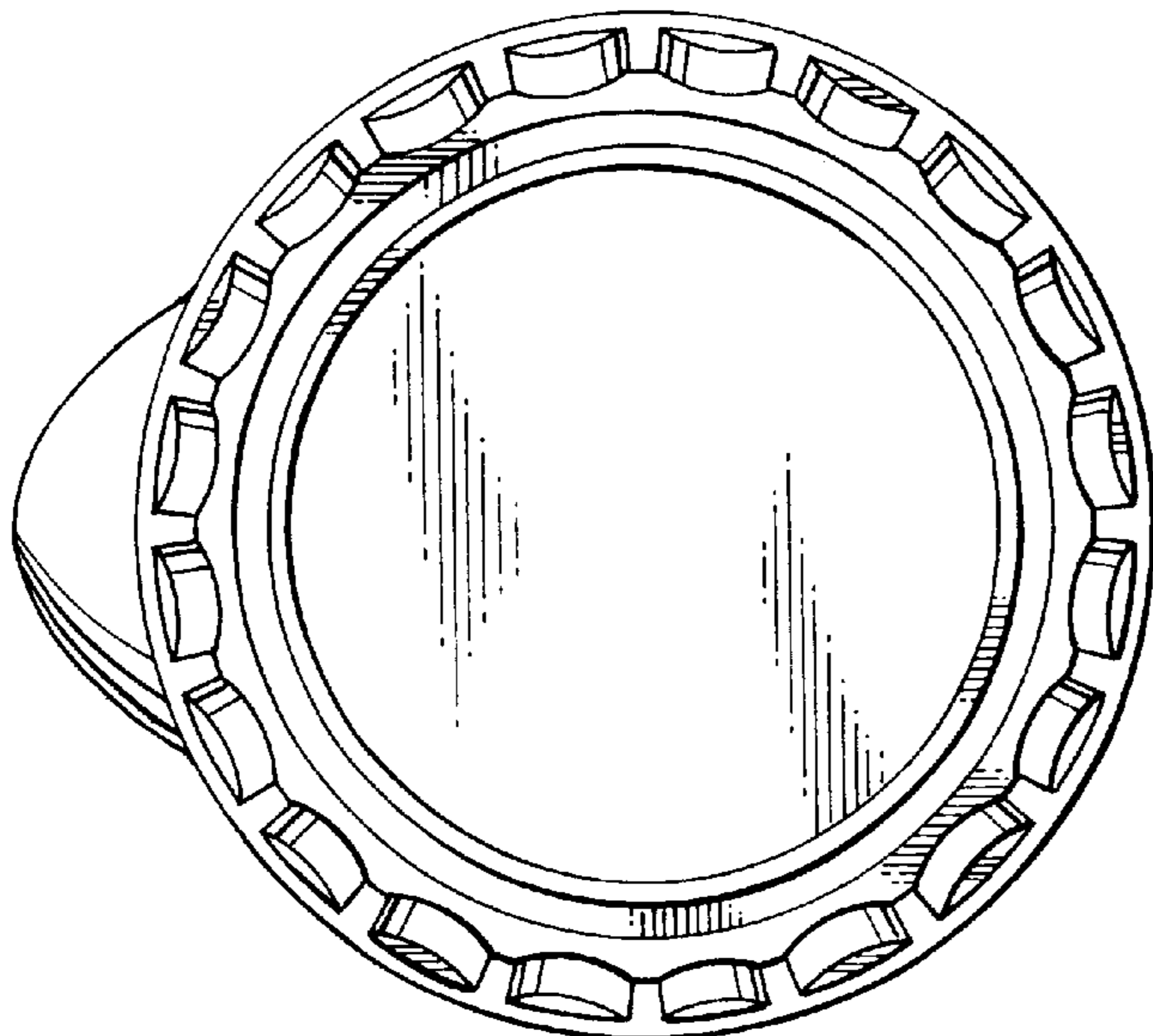

Fig. 4

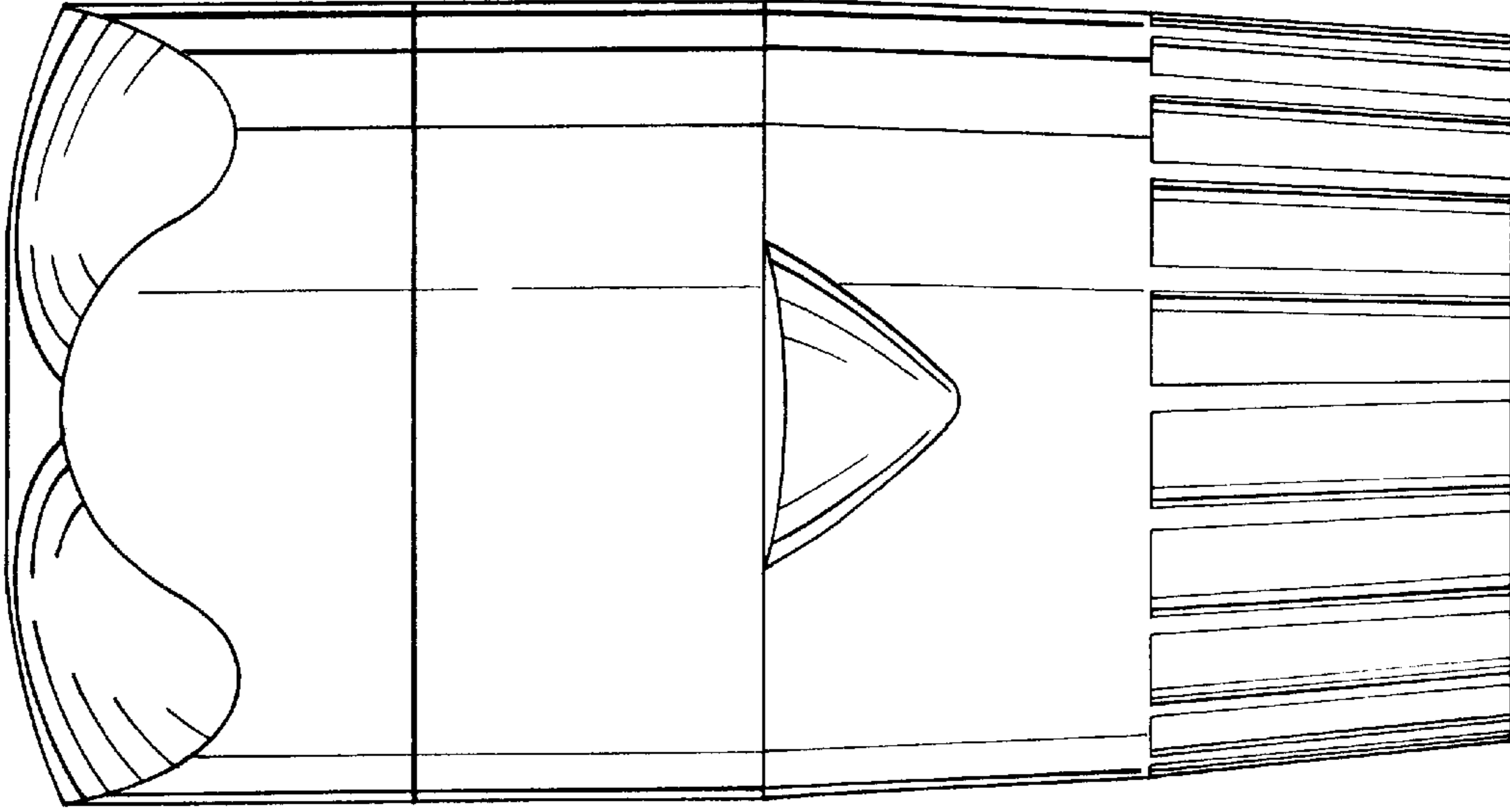

Fig. 6

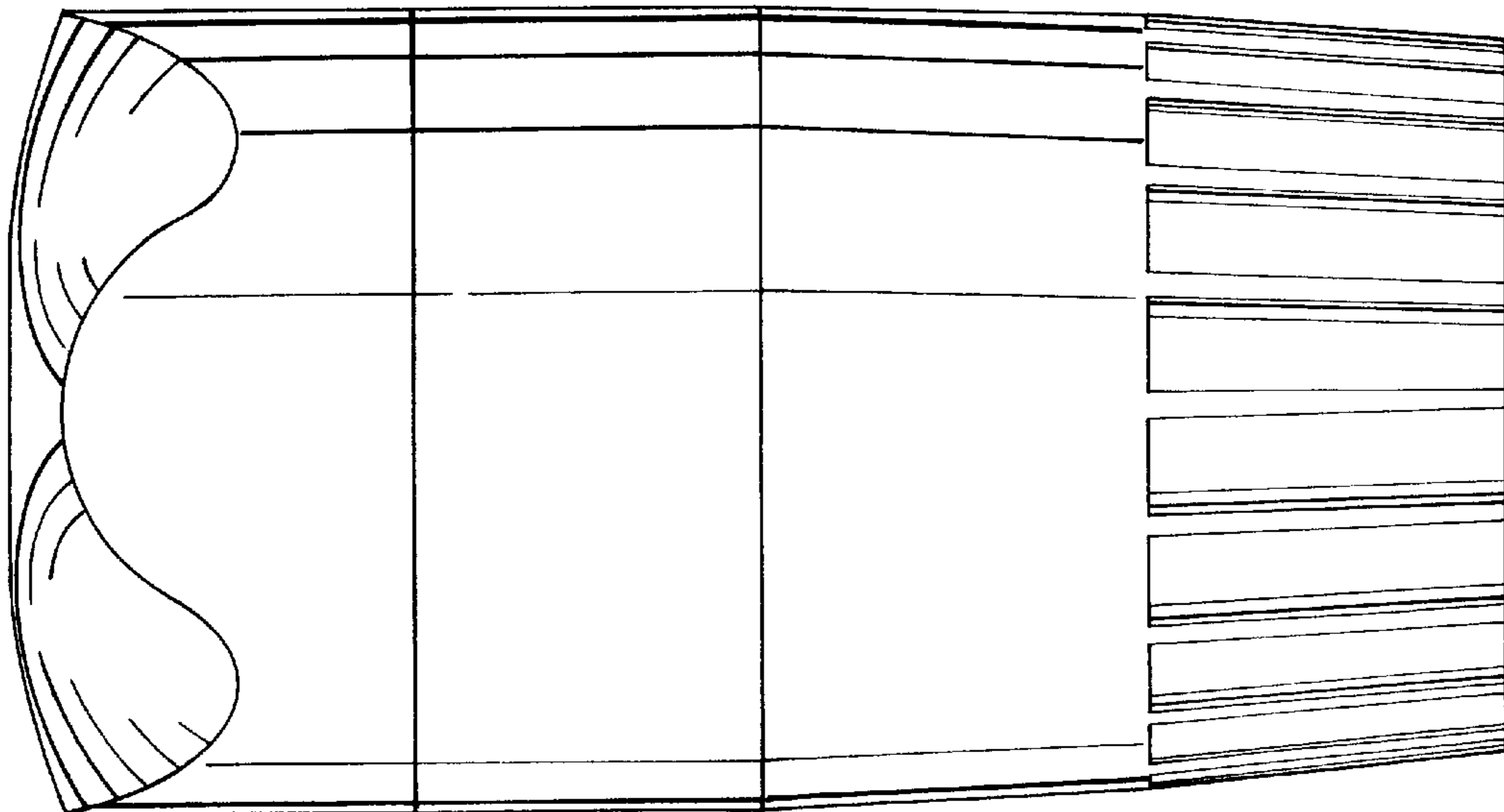

Fig. 5