



US00D477401S

(12) **United States Design Patent**  
**Petherbridge et al.**

(10) **Patent No.:** **US D477,401 S**

(45) **Date of Patent:** **\*\* Jul. 15, 2003**

(54) **PAIR OF FILTER CARTRIDGES FOR A  
POWERED AIR-PURIFYING RESPIRATOR**

(75) Inventors: **Ian T. Petherbridge**, Bognor Regis  
(GB); **David Cook**, Bracknell (GB)

(73) Assignee: **3M Innovative Properties Company**,  
St. Paul, MN (US)

(\*\*) Term: **14 Years**

(21) Appl. No.: **29/127,312**

(22) Filed: **Aug. 3, 2000**

(51) **LOC (7) Cl.** ..... **29-02**

(52) **U.S. Cl.** ..... **D24/110.1**

(58) **Field of Search** ..... D24/110.1, 110.2,  
D24/162, 164, 110.3, 110.5; 128/206.17,  
206.28, 206.21, 206.12, 205.24, 205.25,  
205.27, 205.29, 205.12, 203.29, 201.28,  
201.25, 201.22, 201.17

(56) **References Cited**

**U.S. PATENT DOCUMENTS**

2,295,119	A	*	9/1942	Malcom et al.	.....	128/206.17
2,642,061	A		6/1953	Boyer		
4,088,461	A		5/1978	Brauer		
4,971,052	A		11/1990	Edwards		
5,036,844	A		8/1991	Pouchot et al.		
5,086,768	A	*	2/1992	Niemeyer	.....	128/205.24
D326,540	S	*	5/1992	Scholey	.....	D24/110.1
RE35,062	E	*	10/1995	Brostrom et al.	.....	128/206.12
D396,283	S	*	7/1998	Scholey	.....	D24/110.5
5,906,203	A		5/1999	Klockseth et al.		
6,055,983	A	*	5/2000	Metzger	.....	128/206.17
D440,301	S	*	4/2001	Fecteau et al.	.....	D24/110.1

**FOREIGN PATENT DOCUMENTS**

DE 3818295 A1 7/1989

EP	0 108 560	A1	5/1984
EP	0 164 946	A2	12/1985
EP	0 078 110	B1	5/1986
EP	0 352 938	B1	10/1993
FR	572847		6/1924
JP	64-49257		3/1989
WO	WO 83/00632		3/1983
WO	WO 96/29116		9/1996

**OTHER PUBLICATIONS**

Domestic Preparedness—Powered Air Protection for First Responders C420 Mil-Spec PAPR; SCOTT a Scott Technologies Company (dated Sep. 1999) (a four page brochure).

\* cited by examiner

*Primary Examiner*—Ian Simmons

(74) *Attorney, Agent, or Firm*—Karl G Hanson

(57) **CLAIM**

The ornamental design for a pair of filter cartridges for a powered air-purifying respirator.

**DESCRIPTION**

FIG. 1 is a perspective view of a pair of filter cartridges for a powered air-purifying respirator, showing the new design in solid lines.

FIG. 2 is a top view thereof.

FIG. 3 is a left side view thereof.

FIG. 4 is a front view thereof.

FIG. 5 is a right side view thereof.

FIG. 6 is a bottom view thereof.

FIG. 7 is a rear view thereof; and,

FIG. 8 is a front view thereof, only illustrating the solid line portion of the design.

The broken line showing forms no part of the claimed design. The shading is provided only to illustrate contour; it is not indicative of texture, etc.

**1 Claim, 4 Drawing Sheets**

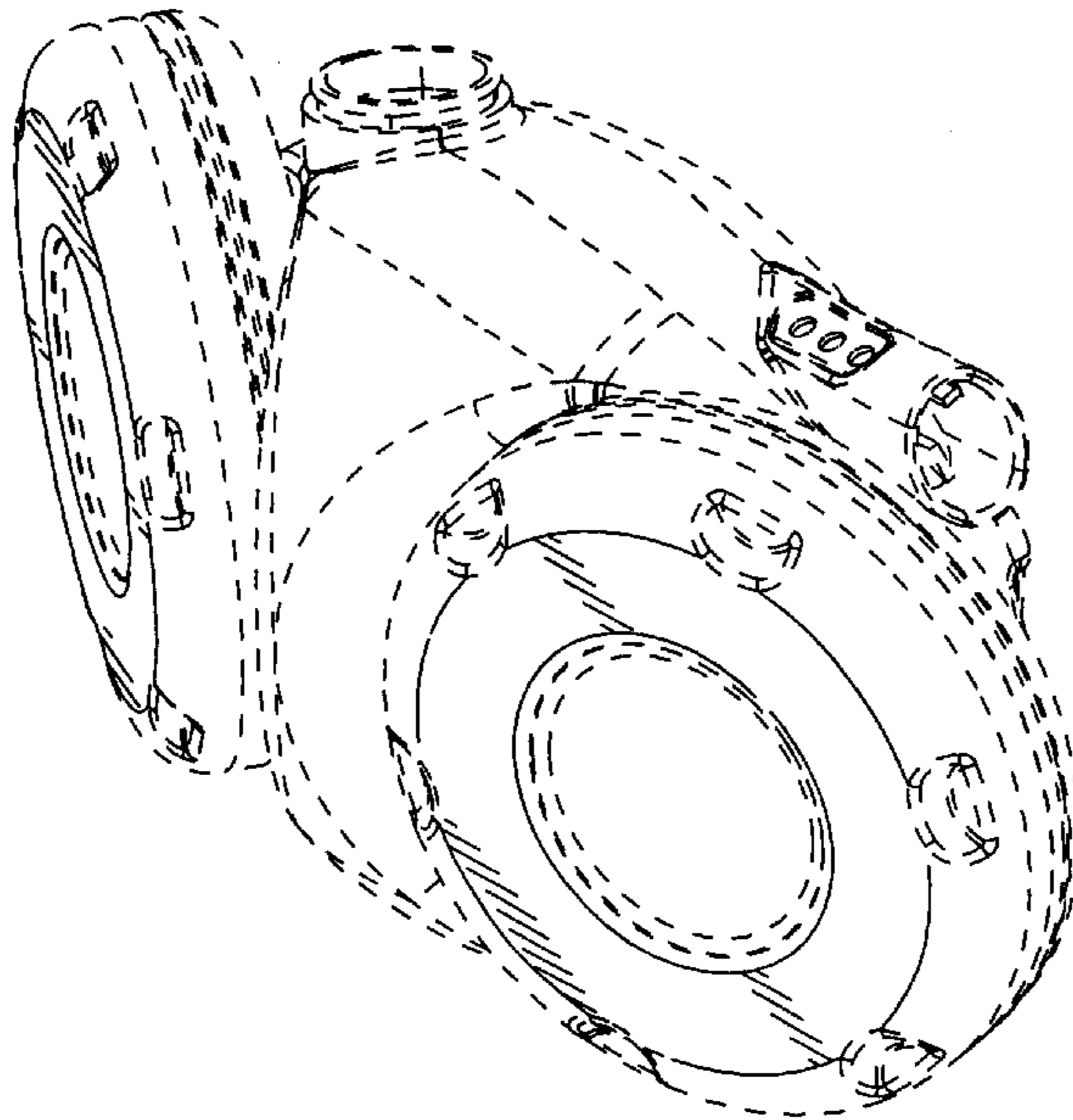

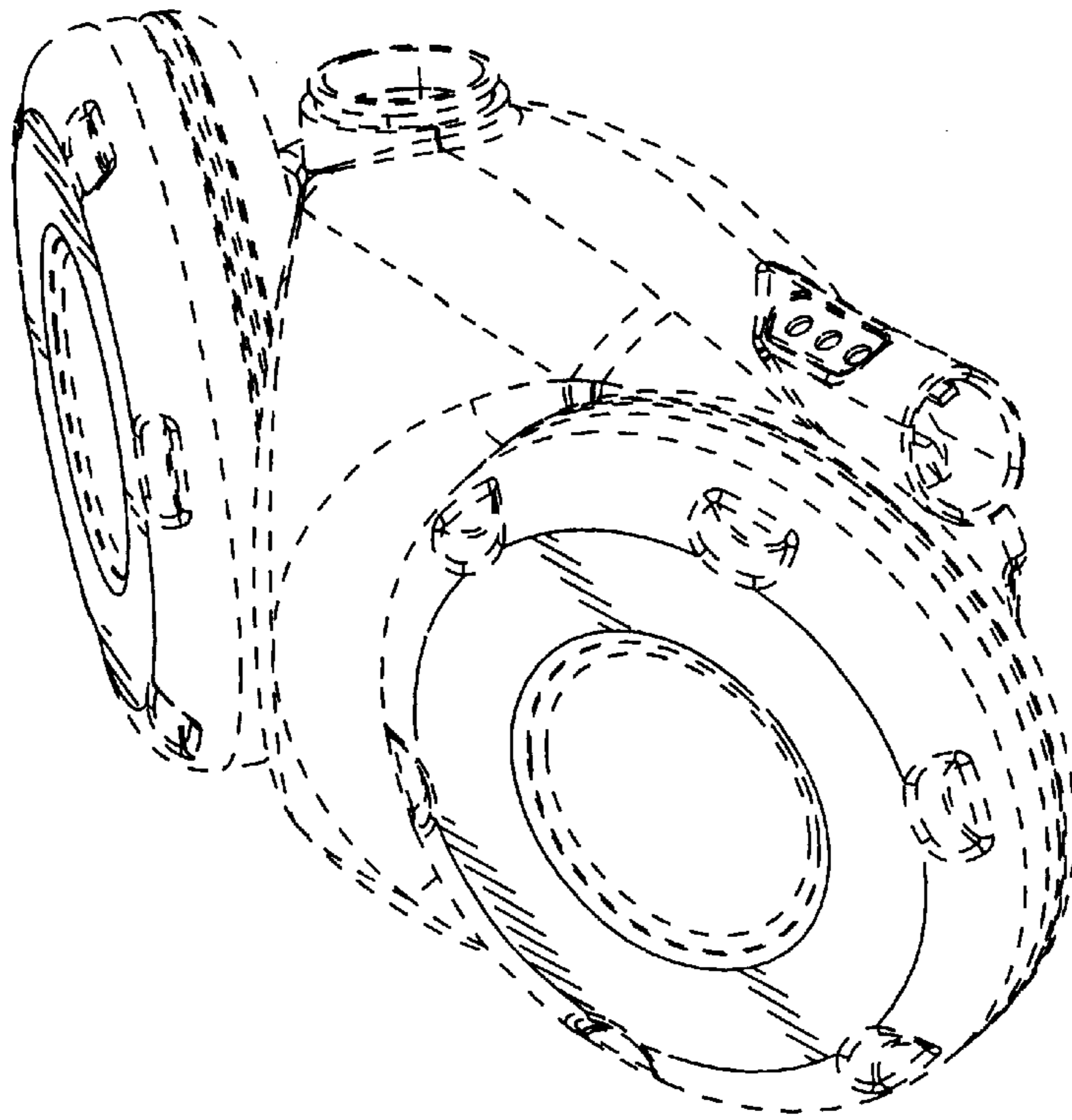

*Fig. 1*

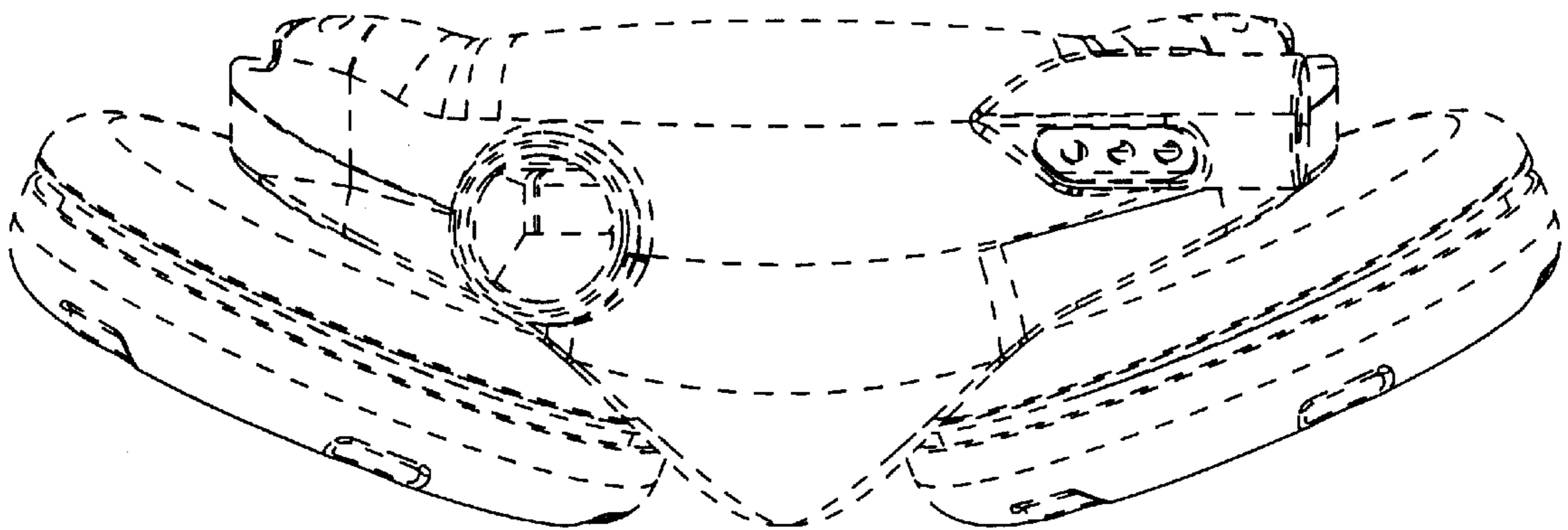

*Fig. 2*

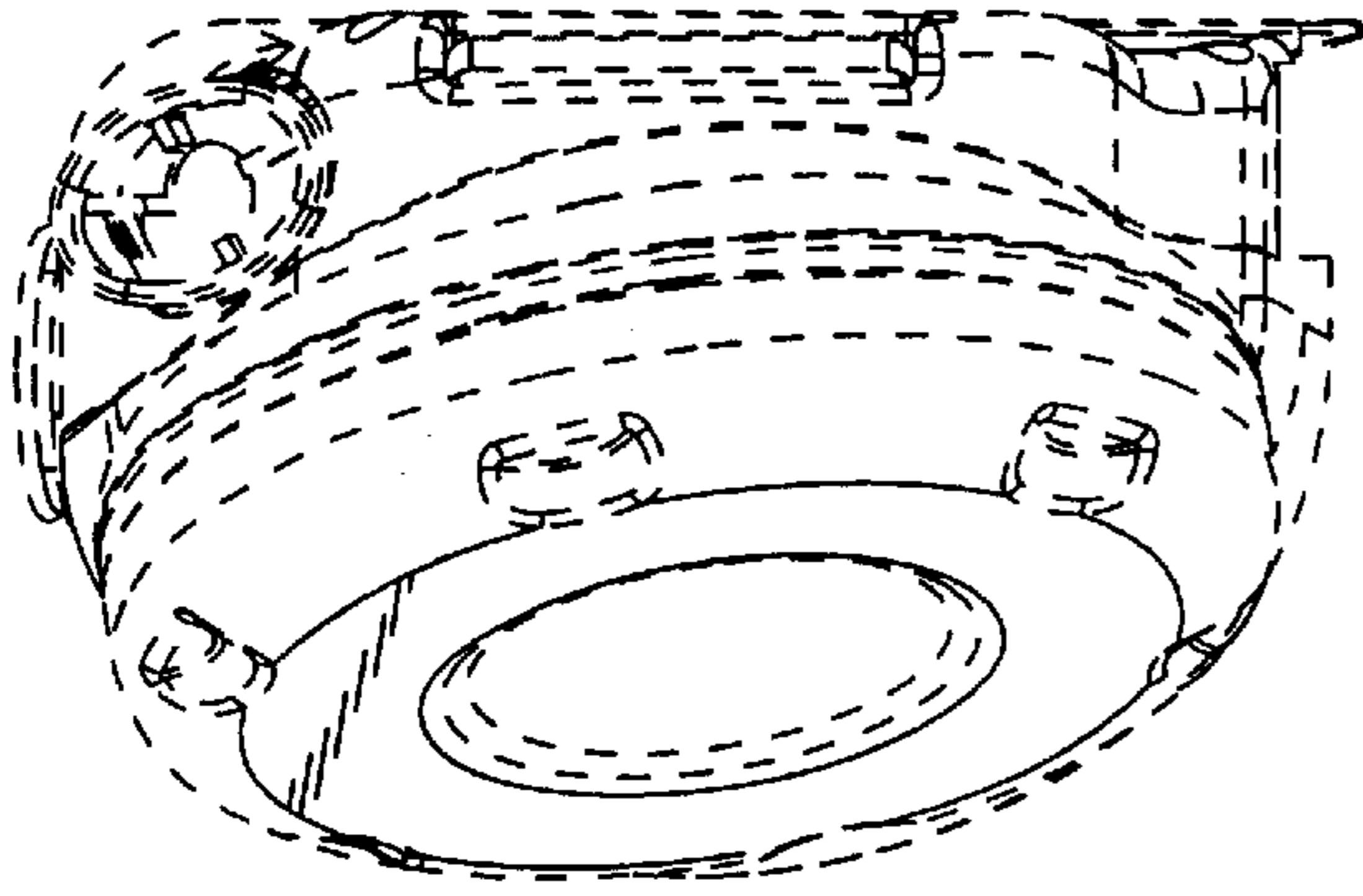

Fig. 5

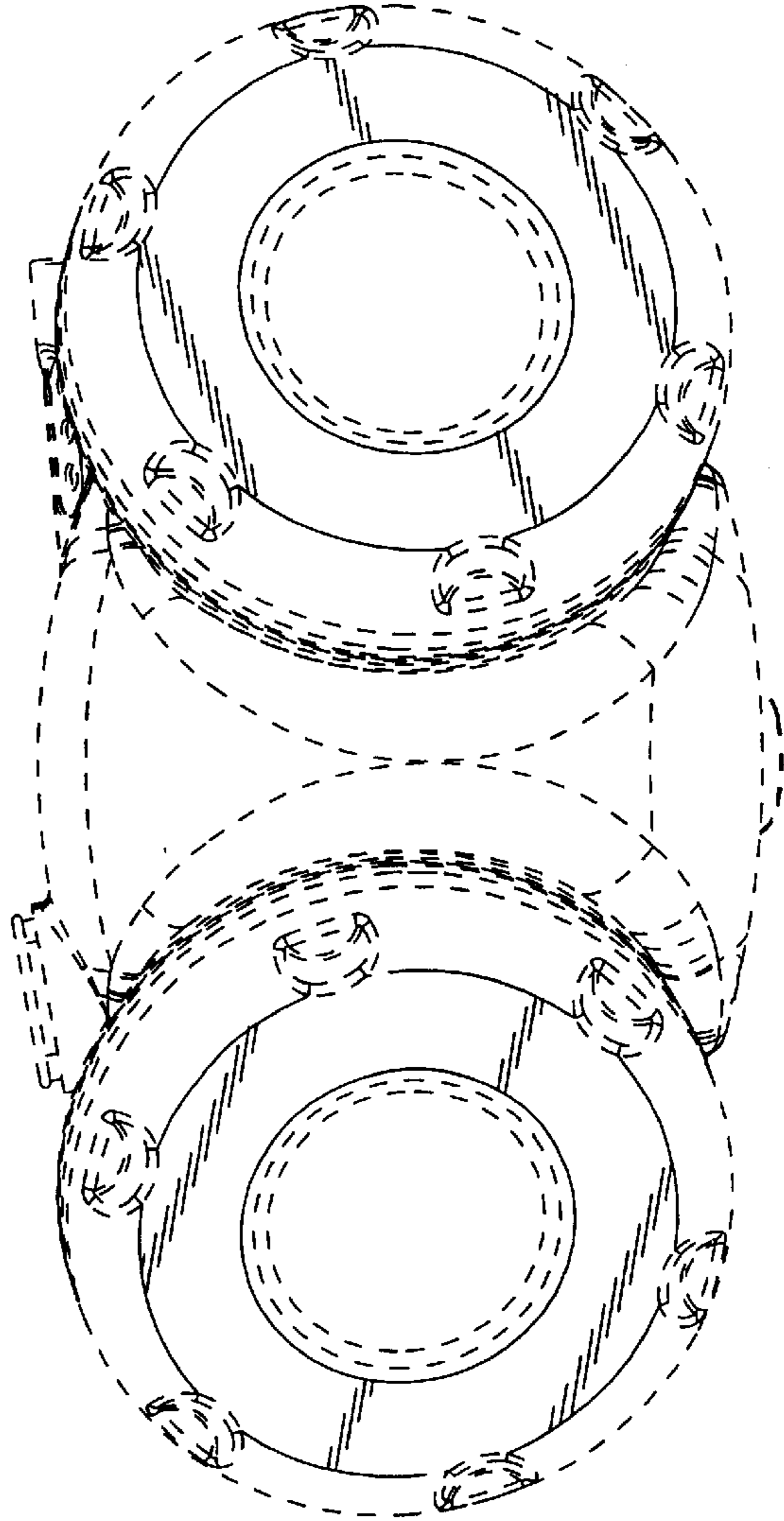

Fig. 4

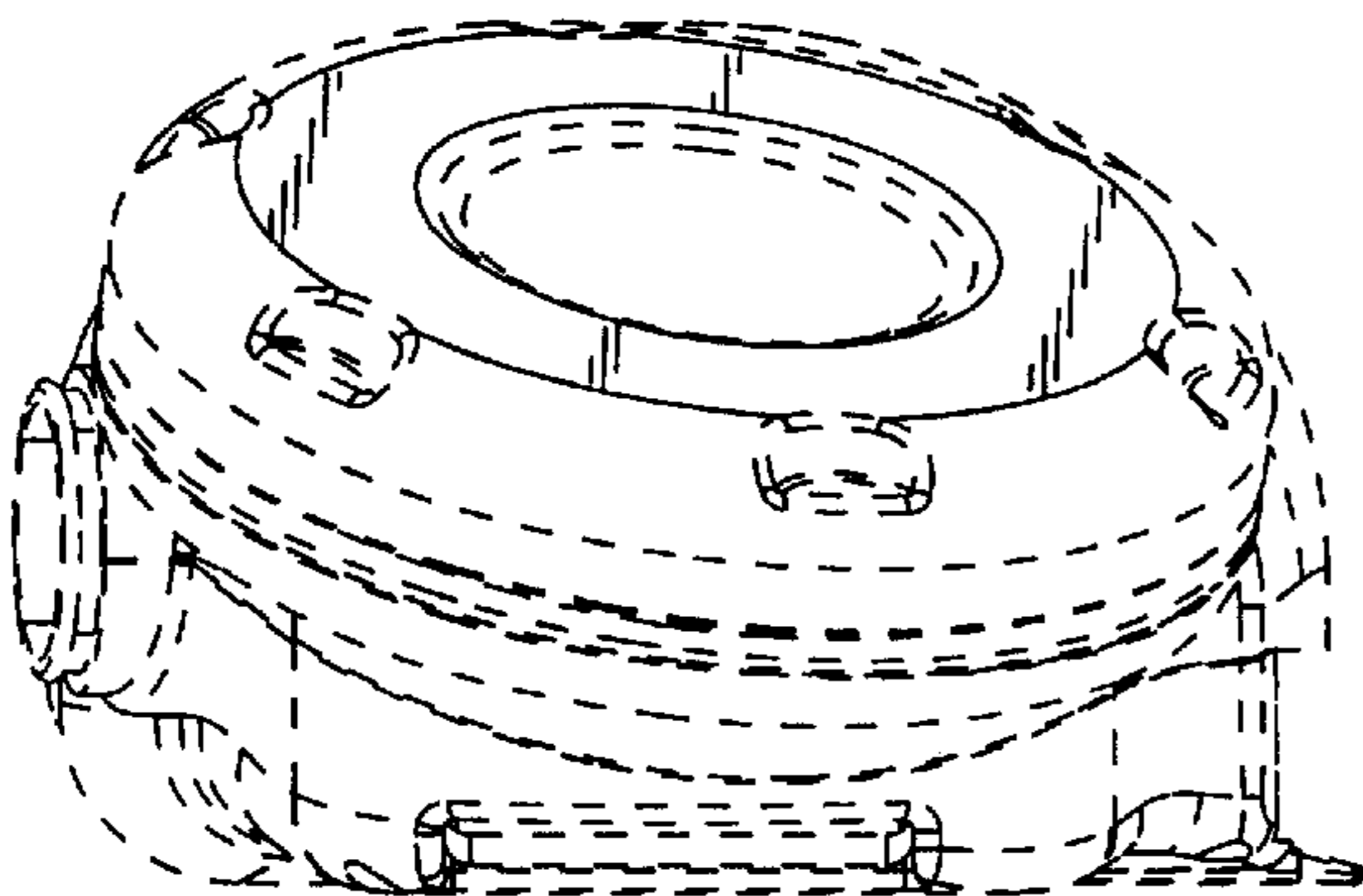

Fig. 3



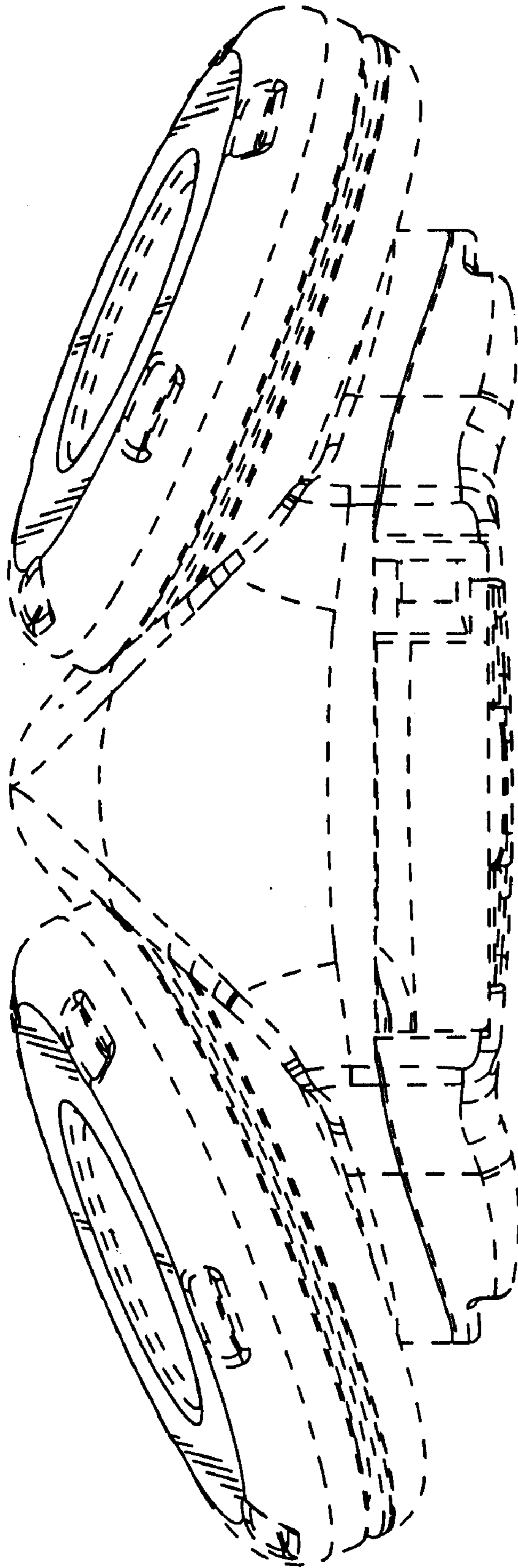
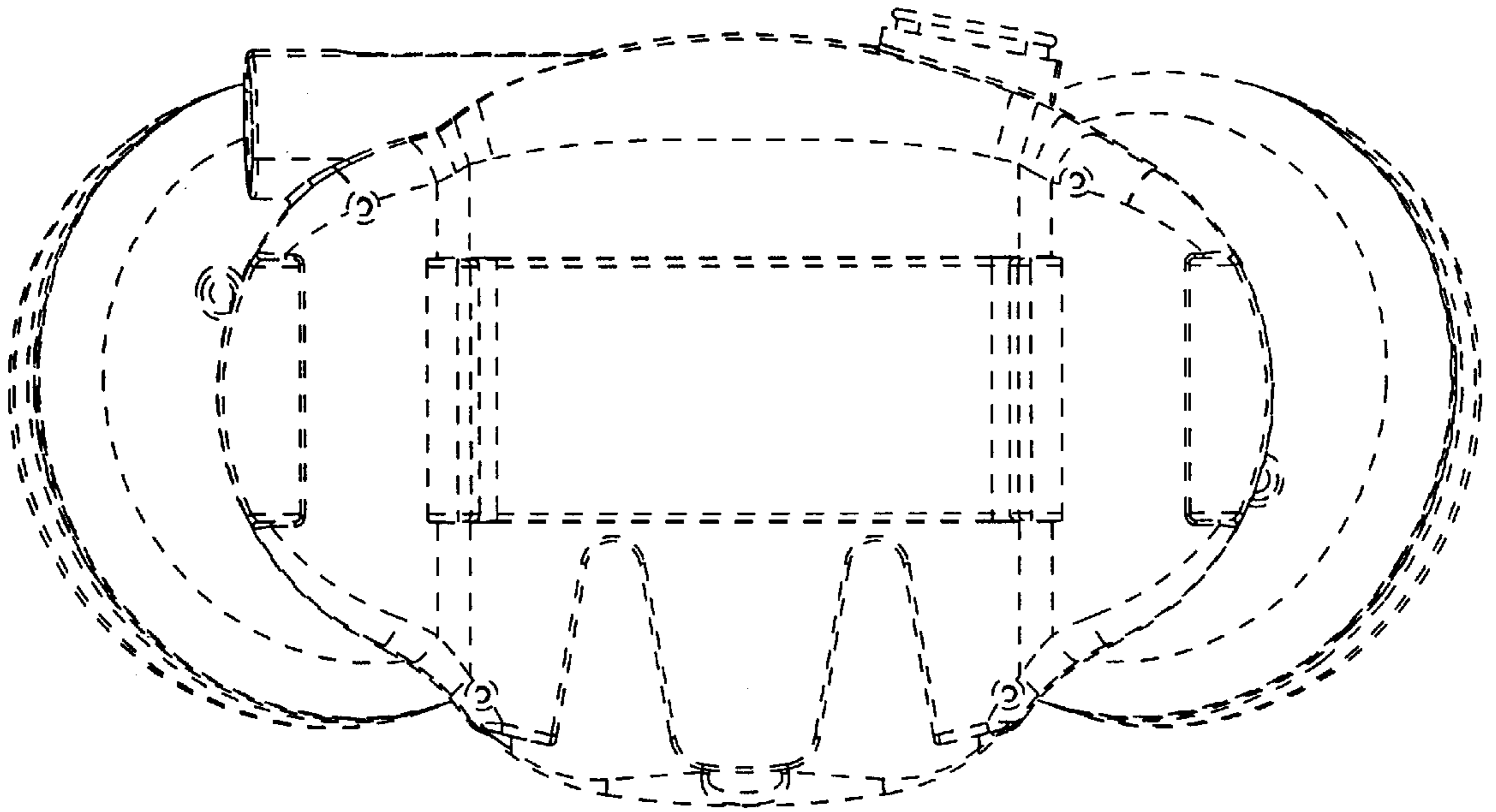
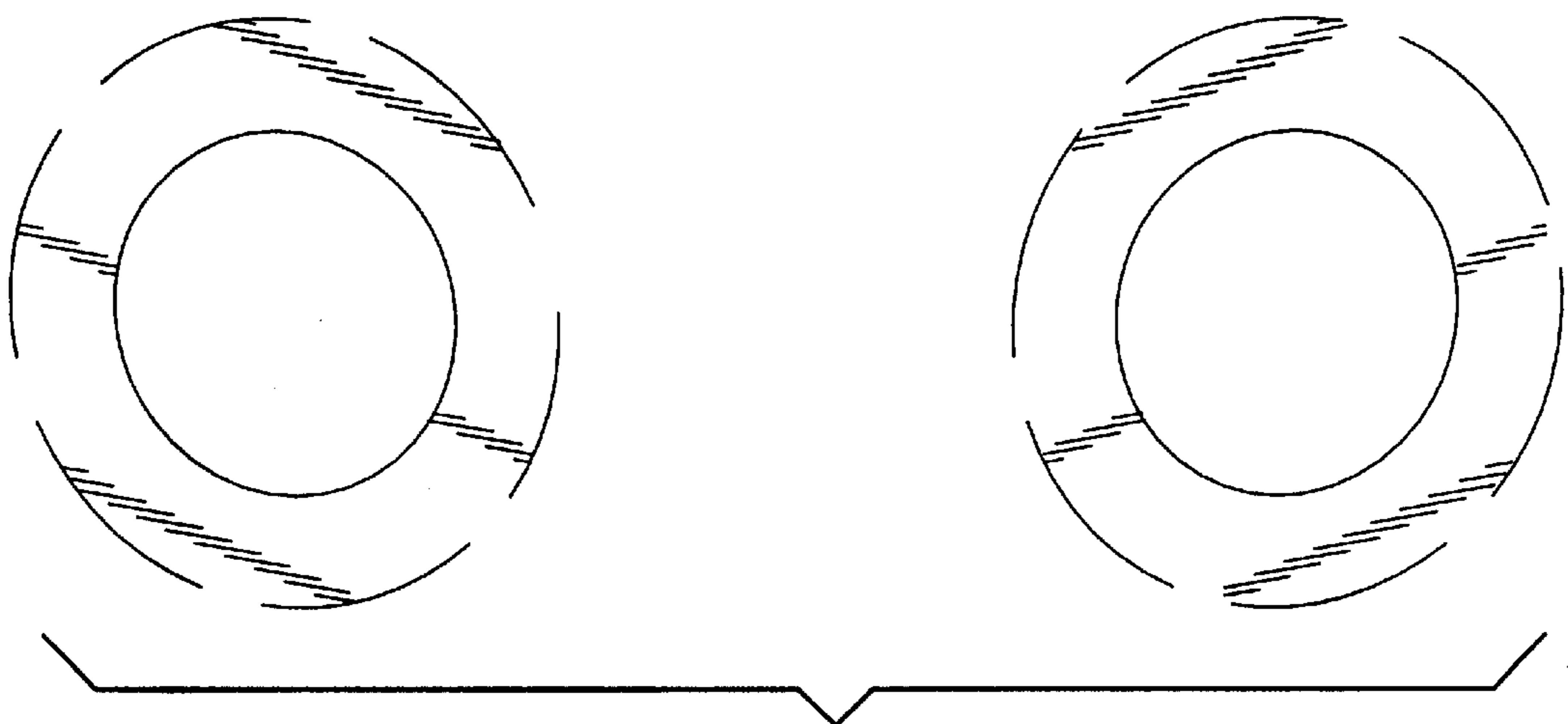

Fig. 6



*Fig. 7*



*Fig. 8*