



US00D477397S

(12) **United States Design Patent**
Chen

(10) **Patent No.:** **US D477,397 S**

(45) **Date of Patent:** **** Jul. 15, 2003**

(54) **BODY OF CEILING FAN**

(74) *Attorney, Agent, or Firm*—Charles E. Baxley

(76) **Inventor:** **Chia-Jeh Chen**, Yi Shian Rd., Sung Shan Chu, Taipei (TW)

(57) **CLAIM**

(**) **Term:** **14 Years**

The ornamental design for a body of ceiling fan, as shown and described.

(21) **Appl. No.:** **29/169,089**

DESCRIPTION

(22) **Filed:** **Oct. 15, 2002**

FIG. 1 is a perspective view of a body of ceiling fan showing my new design;

(51) **LOC (7) Cl.** **23-04**

FIG. 2 is a front elevational view thereof;

(52) **U.S. Cl.** **D23/411**

FIG. 3 is a rear elevational view thereof,

(58) **Field of Search** D23/411, 377,
D23/379, 385; 416/5; 392/364

FIG. 4 is a left side elevational view thereof,

FIG. 5 is a right side elevational view thereof,

FIG. 6 is a top plan view thereof; and

FIG. 7 is a bottom plan view to that shown.

(56) **References Cited**

U.S. PATENT DOCUMENTS

D347,887 S * 6/1994 Liu D23/377

D394,103 S * 5/1998 Lee D23/411

D427,672 S * 7/2000 Lee D23/377

FIG. 8 is a perspective view on a reduced scale body of ceiling fan, the broken lines shown are for illustrative purposes only and form no part of the claimed design; and,

FIG. 9 is a perspective view on a reduced scale body of ceiling fan, the broken lines shown are for illustrative purposes only and from no part of the claimed design.

* cited by examiner

Primary Examiner—Lisa Lichtenstein

1 Claim, 6 Drawing Sheets

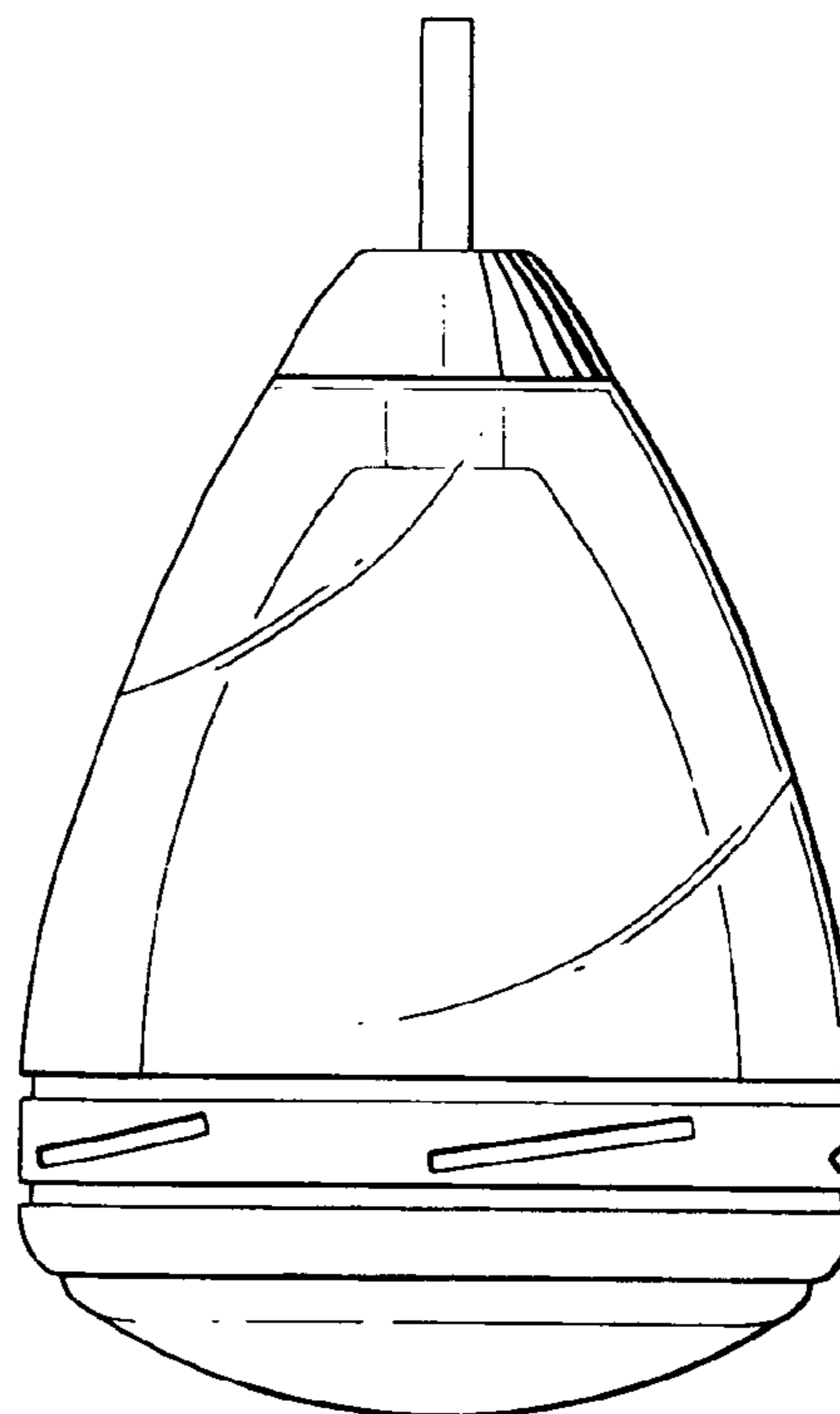
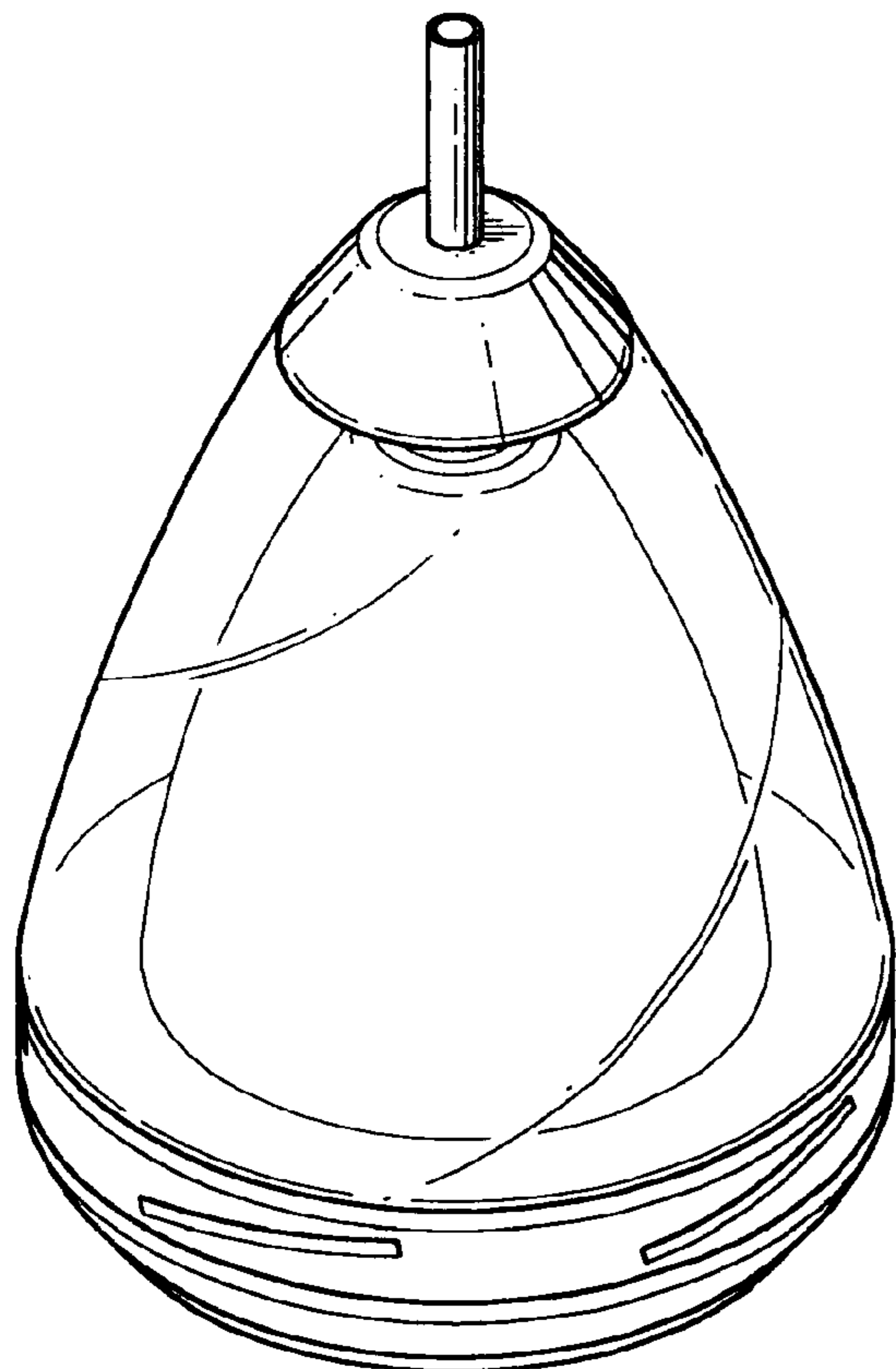

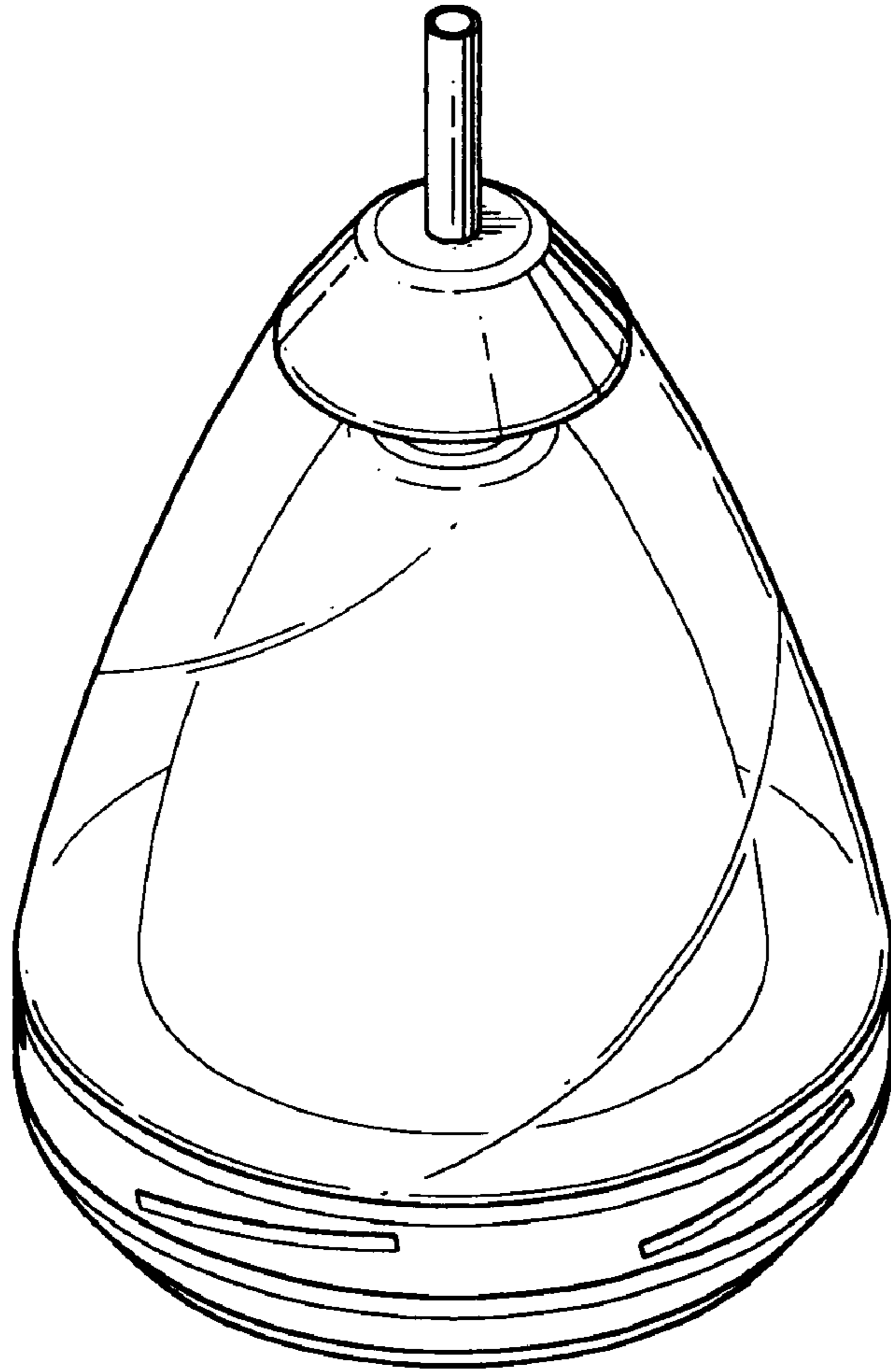

FIG. 1

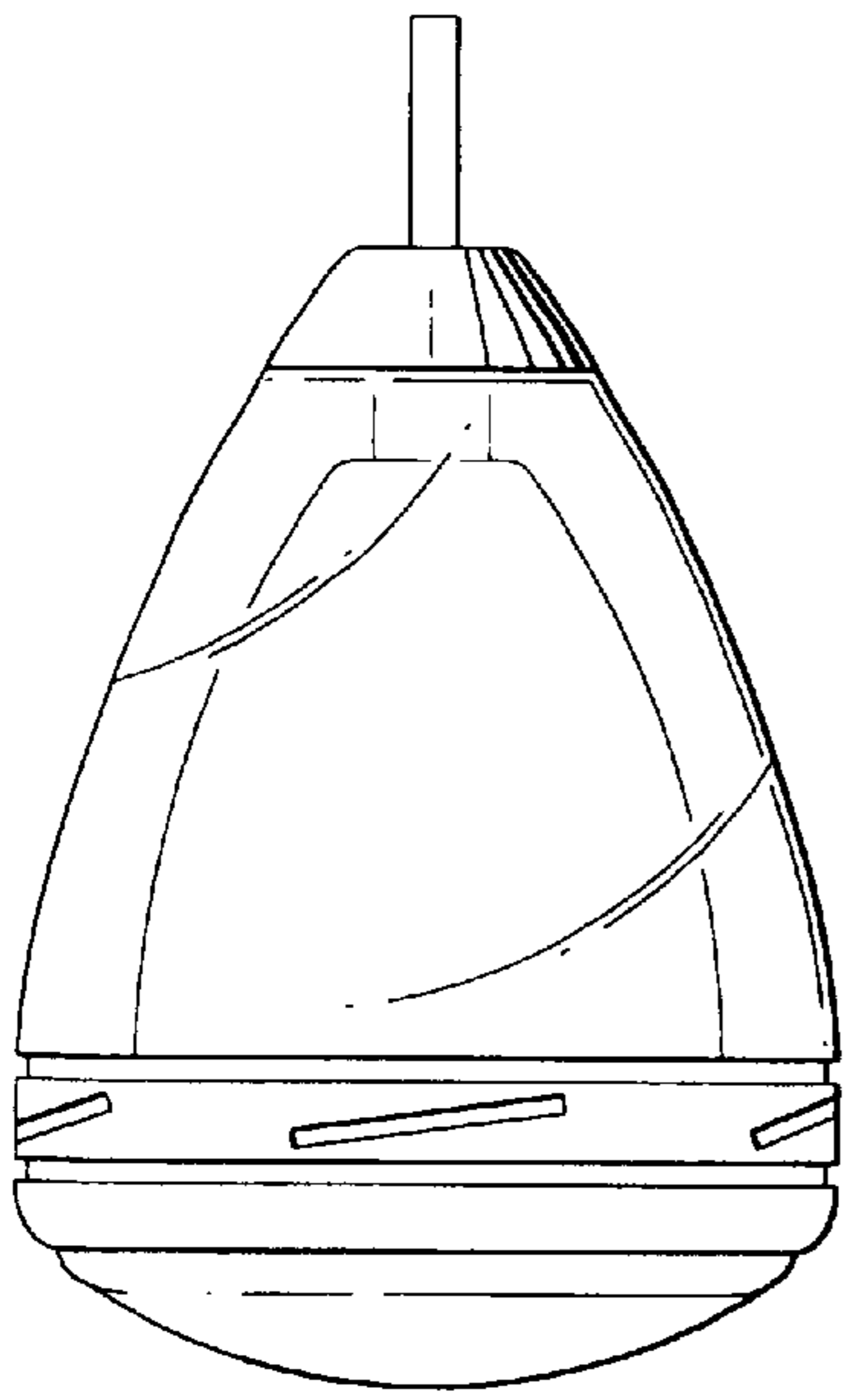

FIG. 2

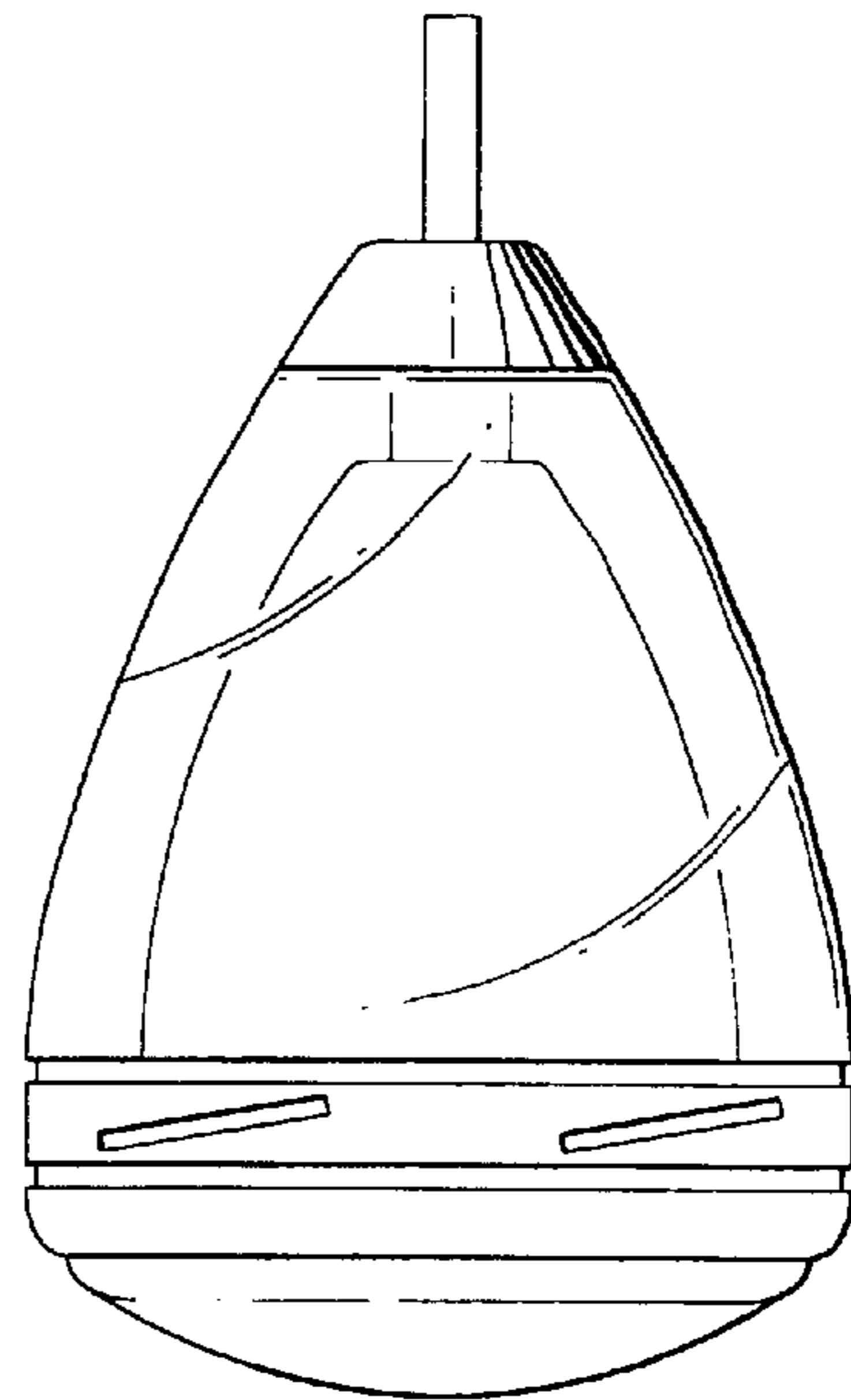

FIG. 3

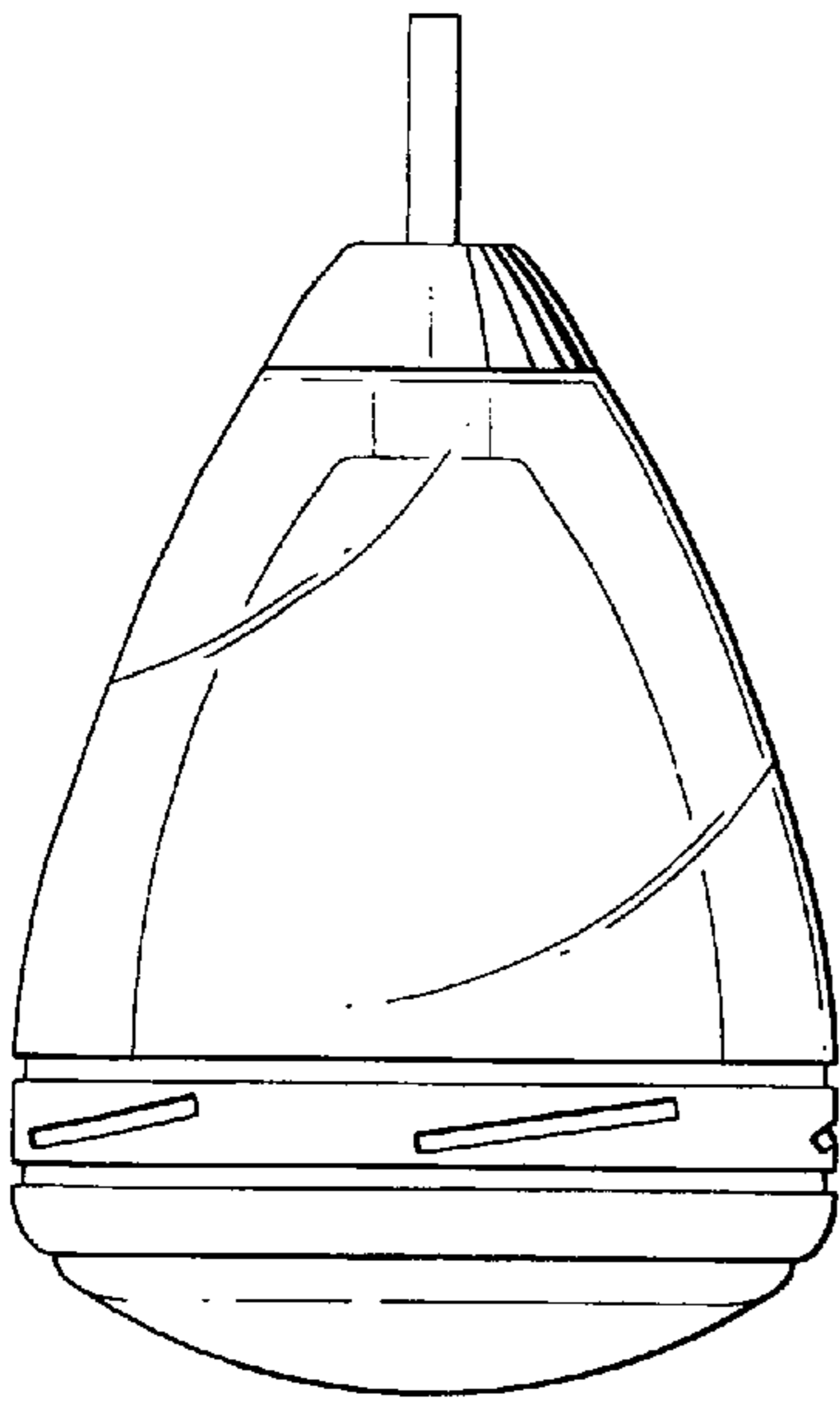

FIG. 4

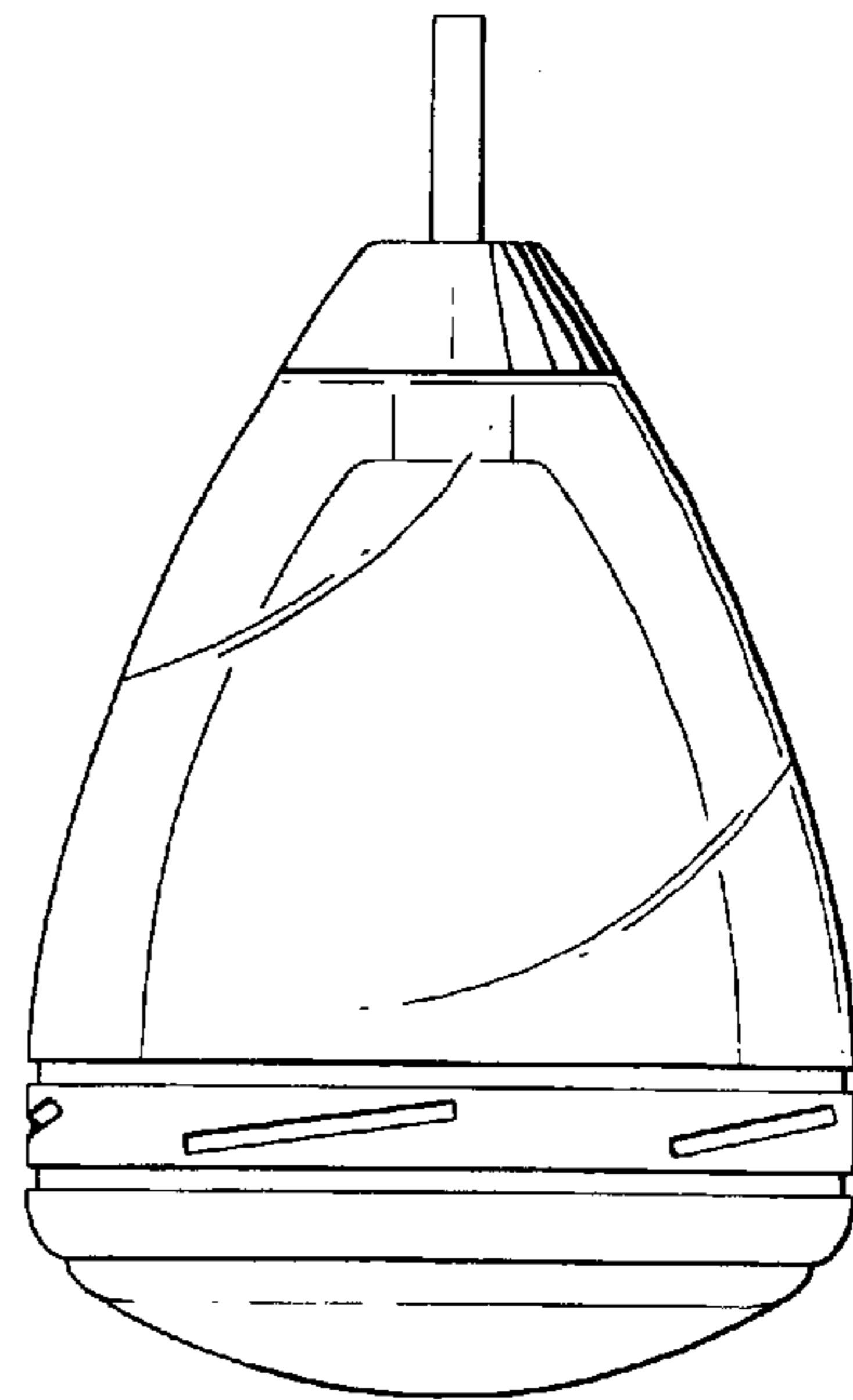

FIG. 5

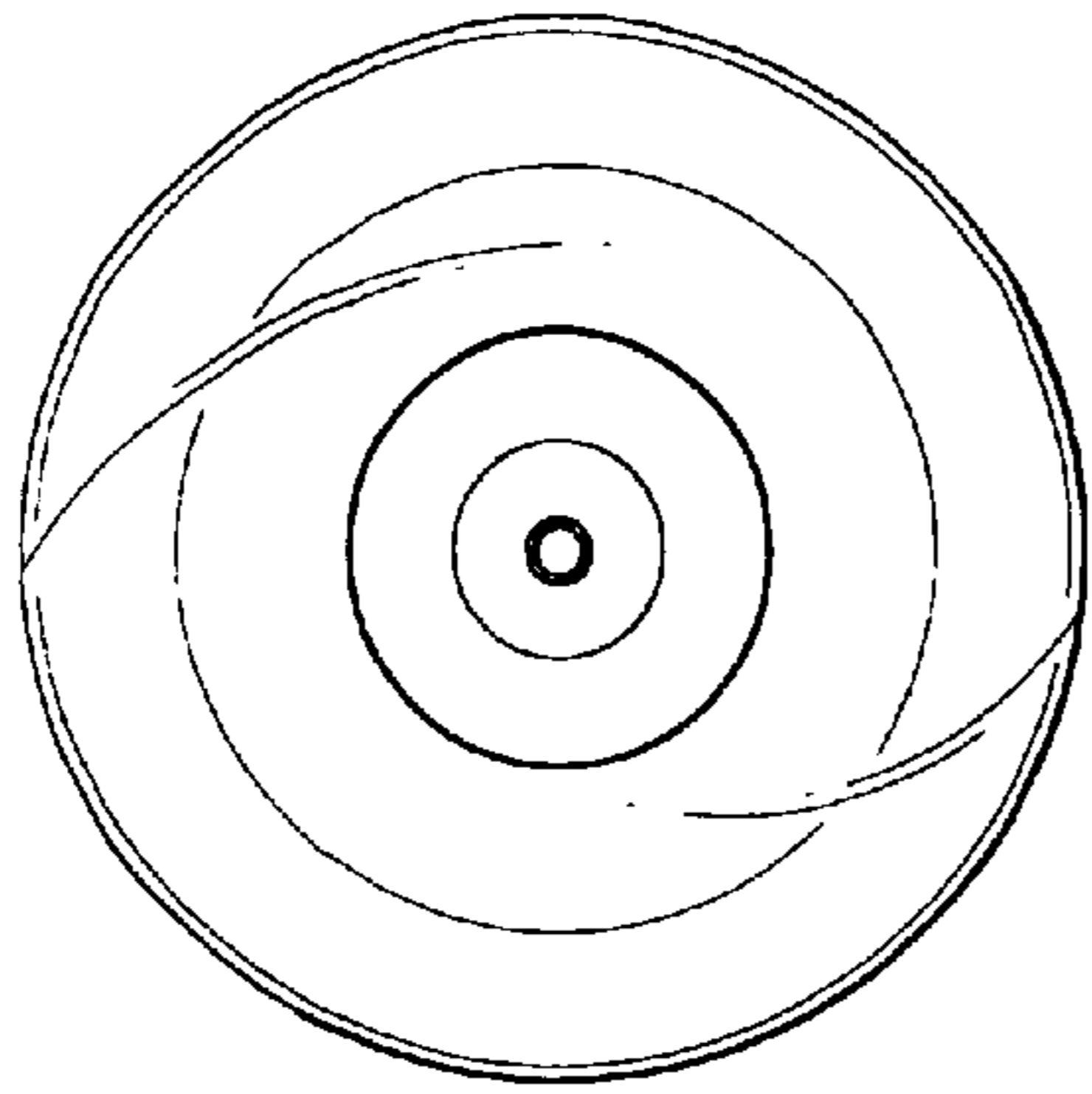

FIG. 6

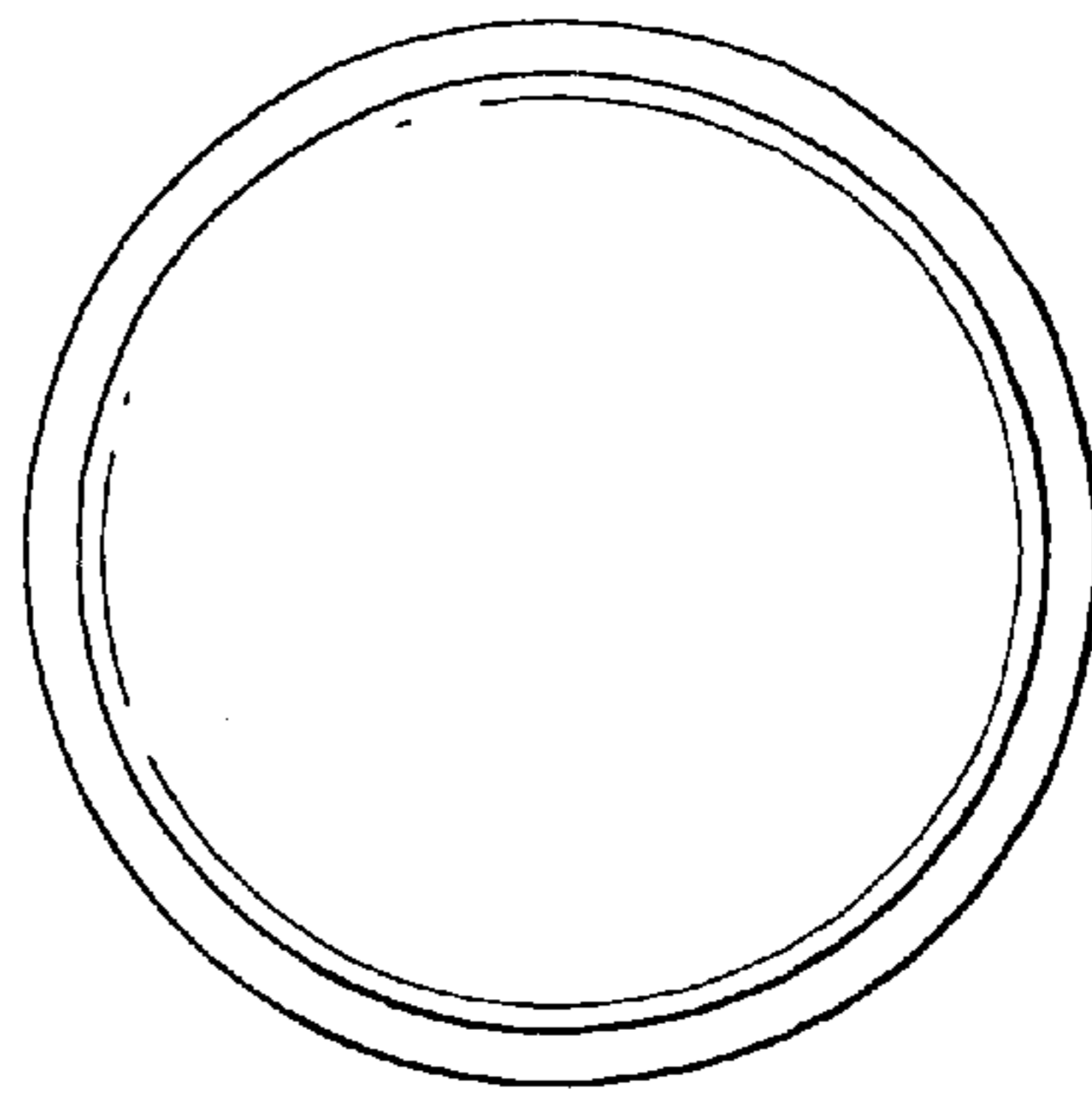
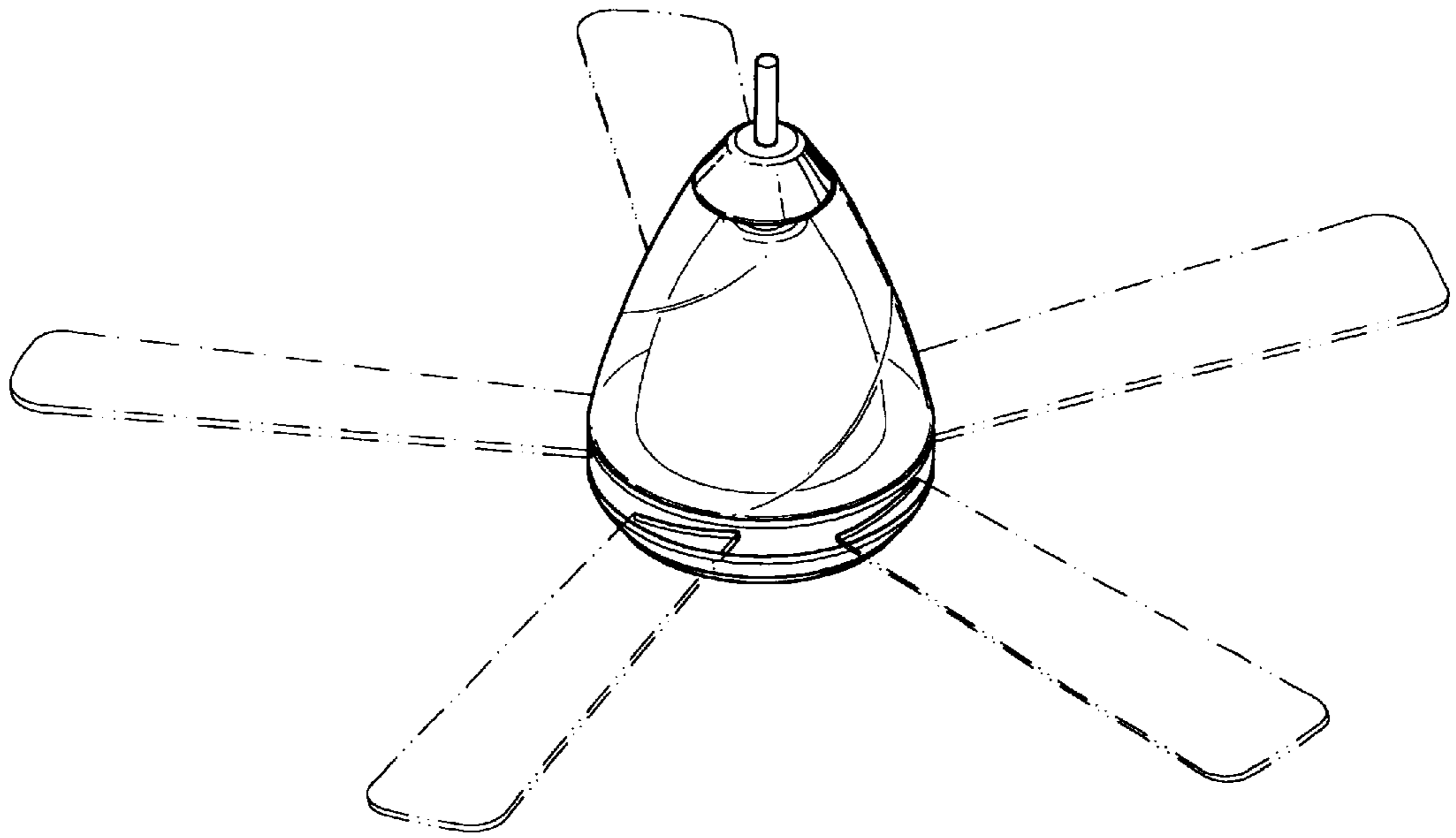

FIG. 7



F I G. 8

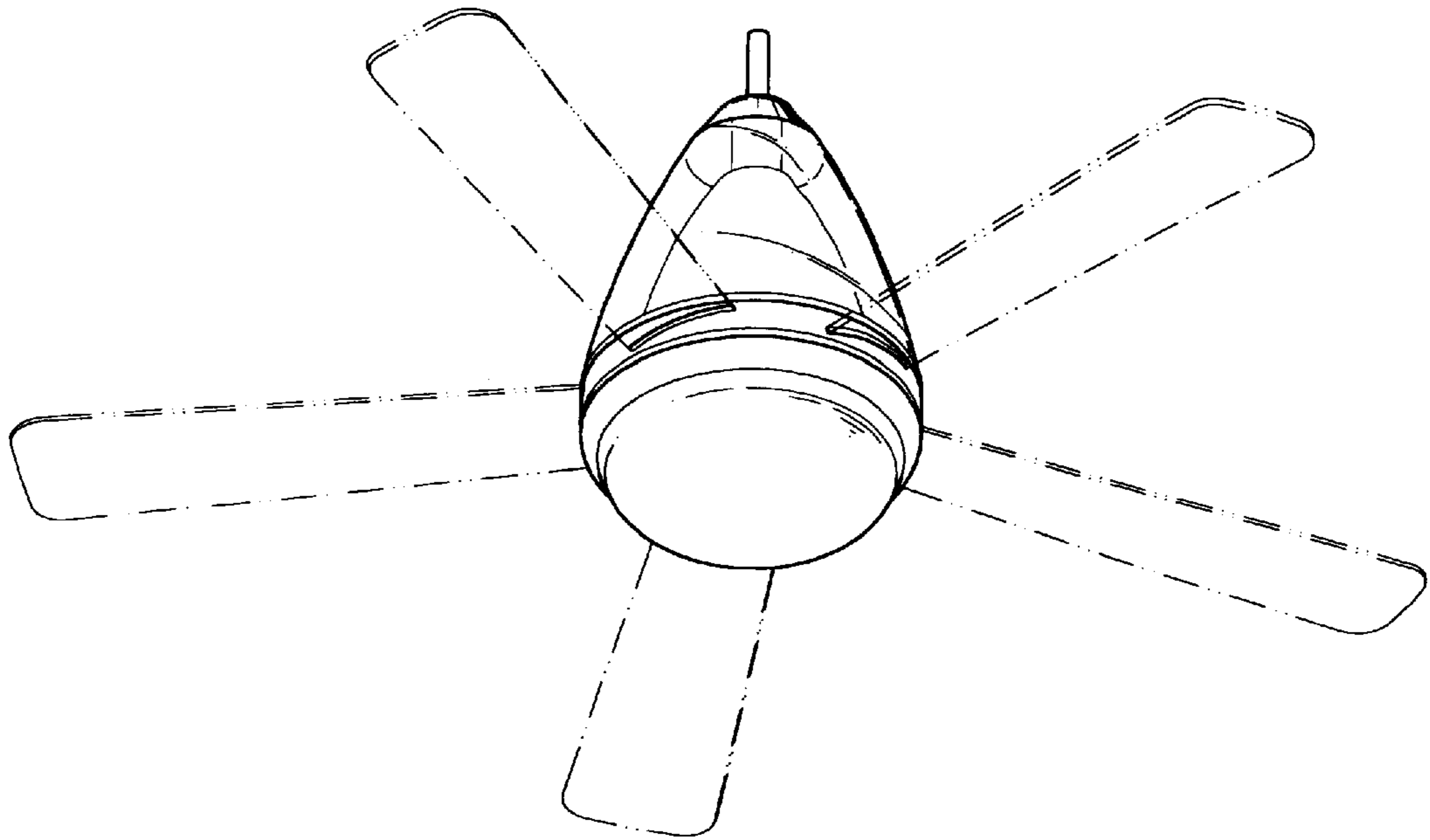

FIG. 9

UNITED STATES PATENT AND TRADEMARK OFFICE
CERTIFICATE OF CORRECTION

PATENT NO. : Des. 477,397 S
DATED : July 15, 2003
INVENTOR(S) : Chen

Page 1 of 1

It is certified that error appears in the above-identified patent and that said Letters Patent is hereby corrected as shown below:

Title page,

Item [76], Inventor, name should read -- **Chia-Teh Chen** --

Signed and Sealed this

Fourteenth Day of October, 2003

A handwritten signature in black ink, appearing to read "James E. Rogan", written over a horizontal line.

JAMES E. ROGAN
Director of the United States Patent and Trademark Office