



US00D477301S

(12) **United States Design Patent**
Hollinger

(10) **Patent No.:** **US D477,301 S**

(45) **Date of Patent:** **** Jul. 15, 2003**

(54) **SHOWER CLOCK RADIO WITH MIRROR**

(75) **Inventor:** **Fred Hollinger**, King's Park, NY (US)

(73) **Assignee:** **E & B Giftware LLC**, Yonkers, NY (US)

(**) **Term:** **14 Years**

(21) **Appl. No.:** **29/161,504**

(22) **Filed:** **May 30, 2002**

(51) **LOC (7) Cl.** **14-01**

(52) **U.S. Cl.** **D14/168**

(58) **Field of Search** D6/300, 553; D10/2, D10/4, 15; D14/168, 170-171, 188-189, 193-198; 312/7.1; 455/90, 100, 344, 347, 350, 351

(56) **References Cited**

U.S. PATENT DOCUMENTS

D139,148 S	*	10/1944	Delucchi	D10/2
D304,920 S	*	12/1989	Schifrin	D12/188
D412,285 S	*	7/1999	Alesi et al.	D10/15
D427,991 S	*	7/2000	Ho	D14/168

* cited by examiner

Primary Examiner—Nanda Bondade

(74) *Attorney, Agent, or Firm*—Gerard F. Dunne

(57) **CLAIM**

The ornamental design for a shower clock radio with mirror, as shown and described.

DESCRIPTION

FIG. 1 is a perspective view of an ornamental design for a shower clock radio with mirror;

FIG. 2 is a front view thereof;
 FIG. 3 is a left side view thereof;
 FIG. 4 is a right side view thereof;
 FIG. 5 is a rear view thereof;
 FIG. 6 is a top plan view thereof;
 FIG. 7 is a bottom plan view thereof;
 FIG. 8 is a perspective view of a second embodiment of an ornamental design for a shower clock radio with mirror;
 FIG. 9 is a front view of the embodiment of FIG. 8;
 FIG. 10 is a left side view of the embodiment of FIG. 8;
 FIG. 11 is a right side view of the embodiment of FIG. 8;
 FIG. 12 is a rear view of the embodiment of FIG. 8;
 FIG. 13 is a top plan view of the embodiment of FIG. 8;
 FIG. 14 is a bottom plan view of the embodiment of FIG. 8;
 FIG. 15 is a perspective view of a third embodiment of an ornamental design for a shower clock radio with mirror;
 FIG. 16 is a front view of the embodiment of FIG. 15;
 FIG. 17 is a right side view of the embodiment of FIG. 15;
 FIG. 18 is a left side view of the embodiment of FIG. 15;
 FIG. 19 is a rear view of the embodiment of FIG. 15;
 FIG. 20 is a top plan view of the embodiment of FIG. 15;
 FIG. 21 is a bottom plan view of the embodiment of FIG. 15;
 FIG. 22 is a perspective view of a fourth embodiment of an ornamental design for a shower clock radio with mirror;
 FIG. 23 is a front view of the embodiment of FIG. 22;
 FIG. 24 is a left side view of the embodiment of FIG. 22;
 FIG. 25 is a right side view of the embodiment of FIG. 22;
 FIG. 26 is a rear view of the embodiment of FIG. 22;
 FIG. 27 is a top plan view of the embodiment of FIG. 22;
 and,
 FIG. 28 is a bottom plan view of the embodiment of FIG. 22.
 The broken line showing on FIGS. 1-2, 8-9, 15-16, 22-23 and 28 is for illustrative purposes only and forms no part of the claimed design.

1 Claim, 20 Drawing Sheets

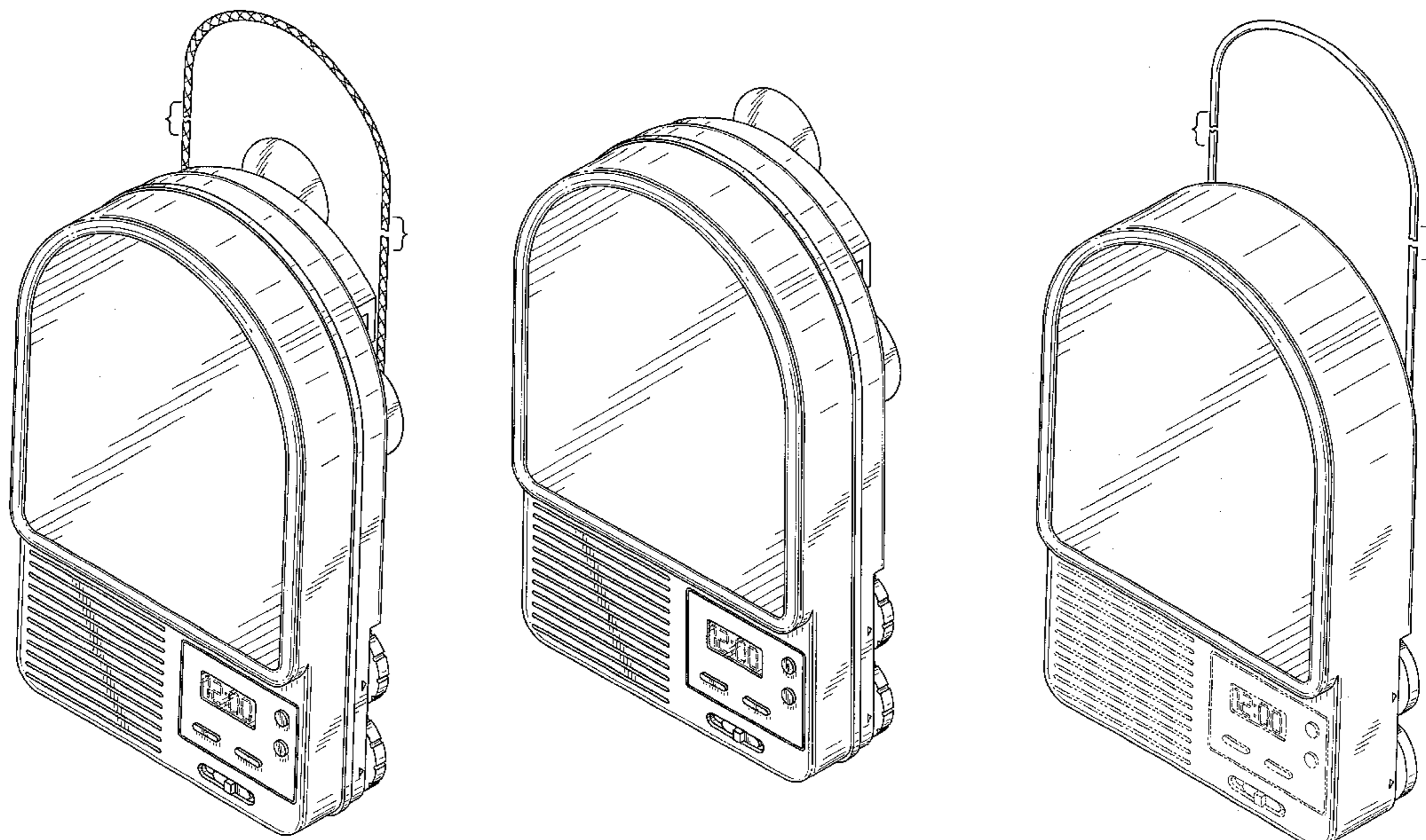

FIG. 1

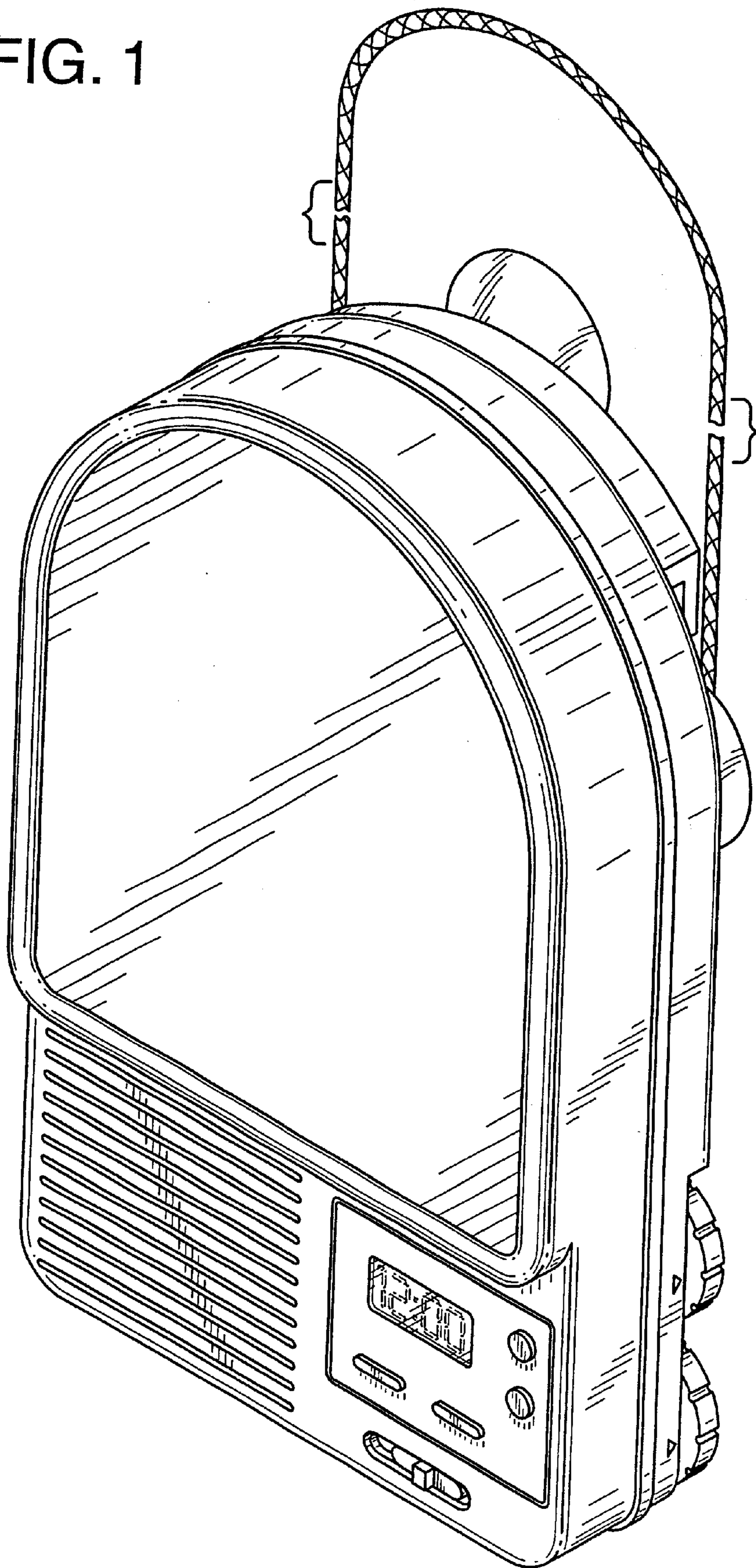

FIG. 2

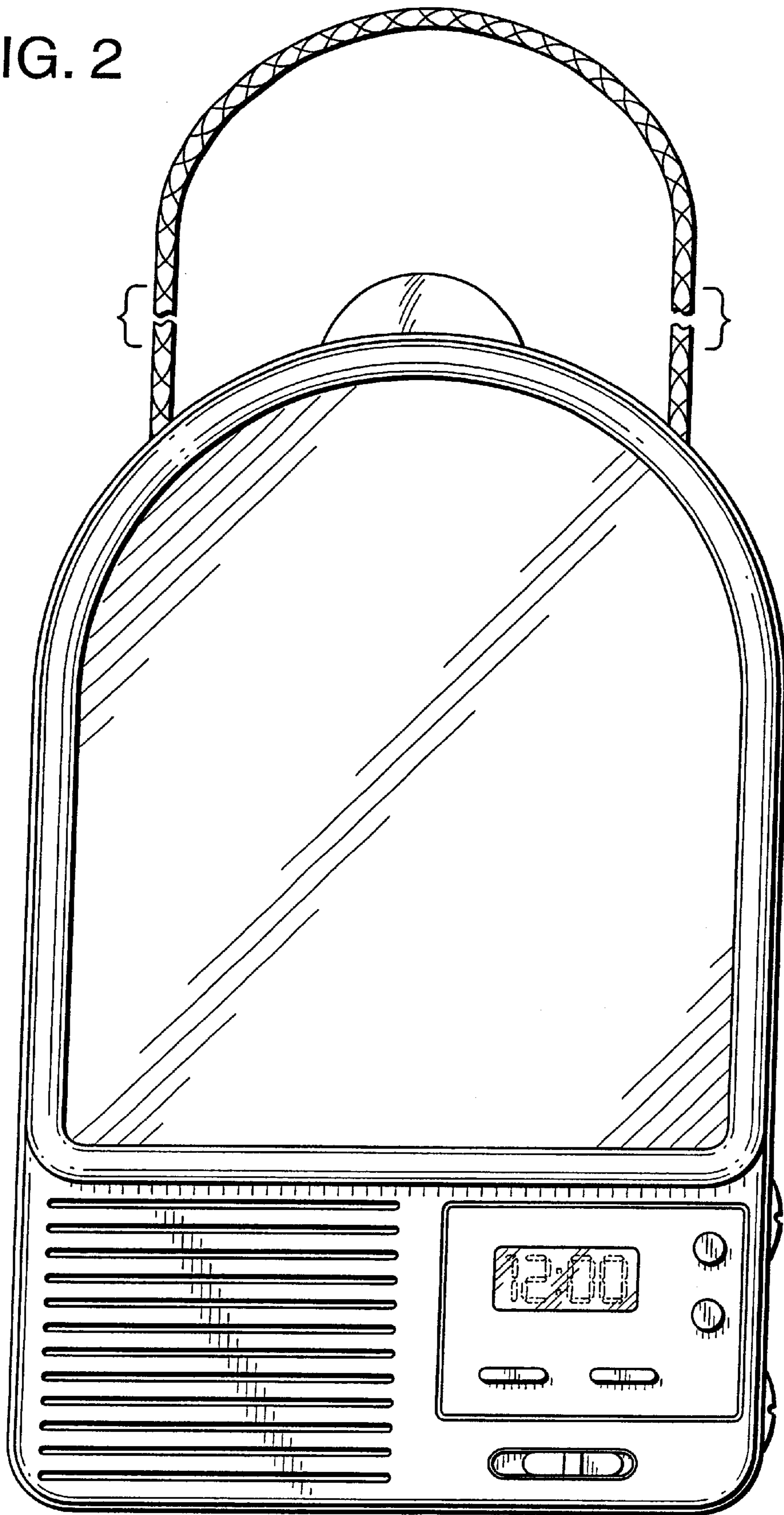

FIG. 3

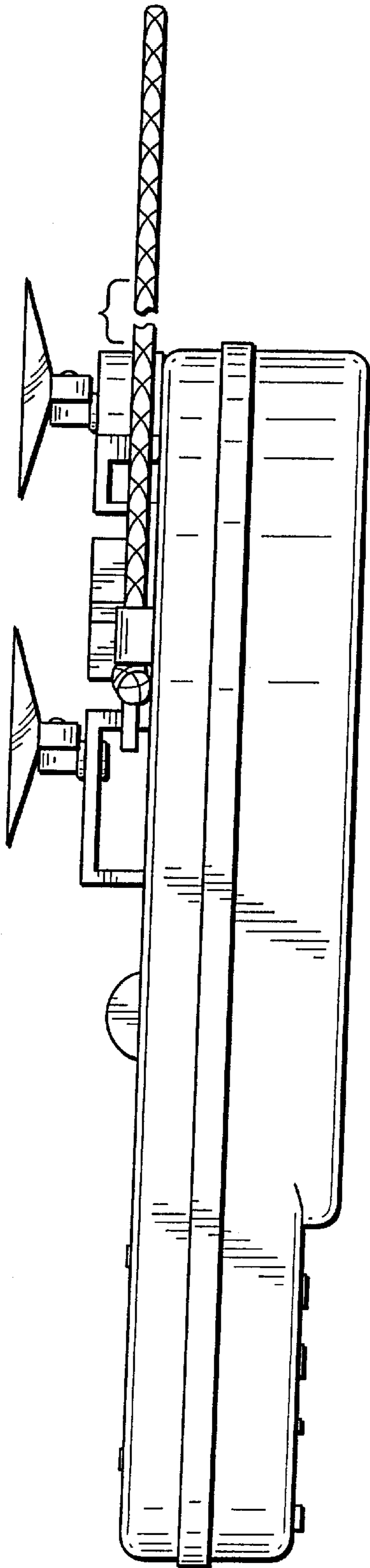

FIG. 4

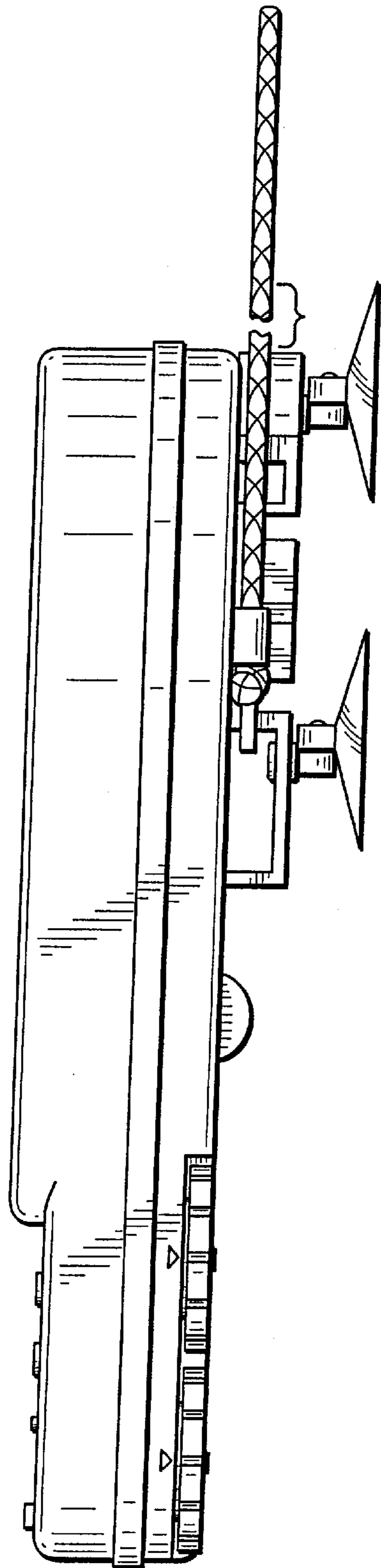

FIG. 5

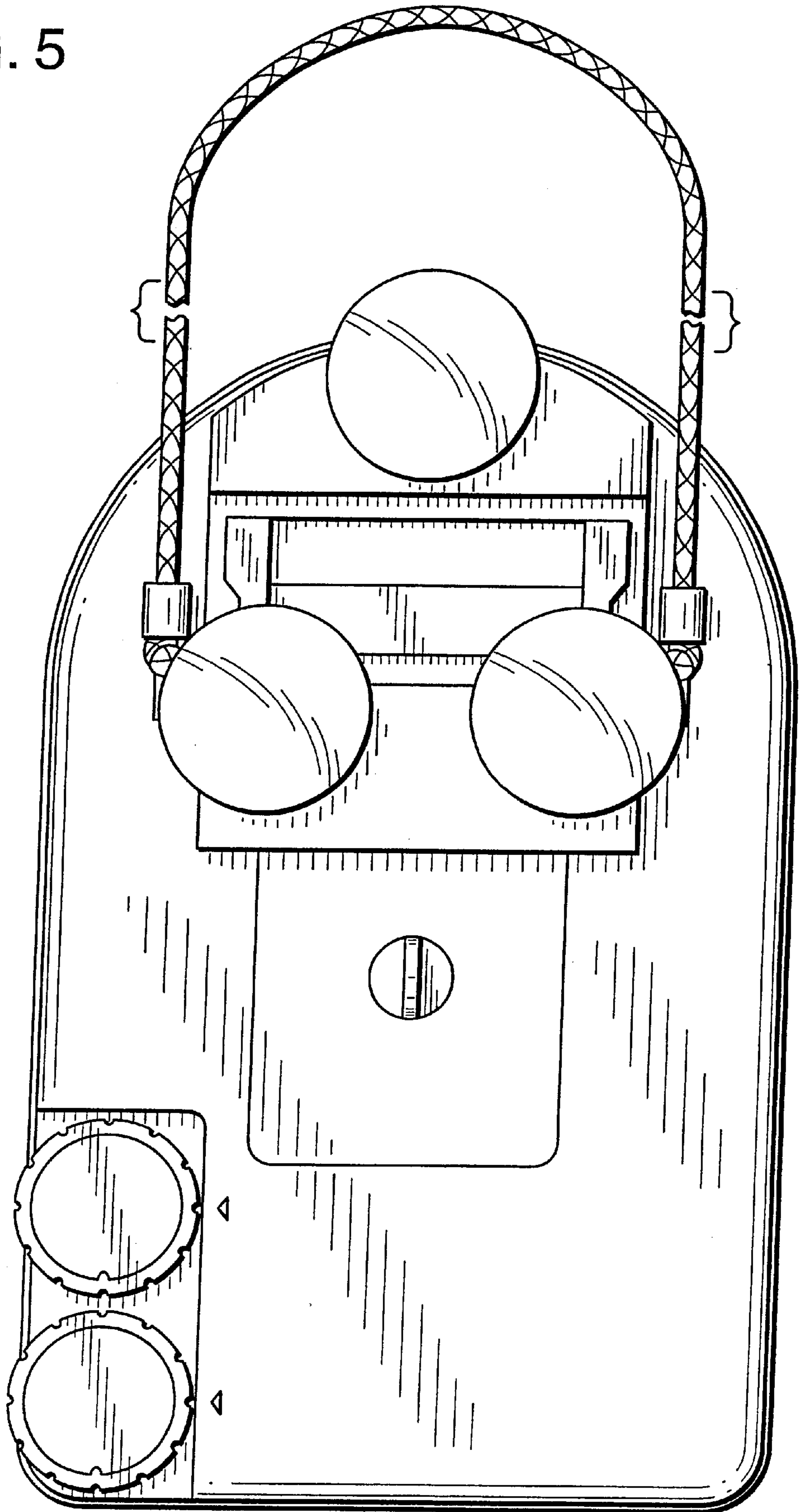

FIG. 6

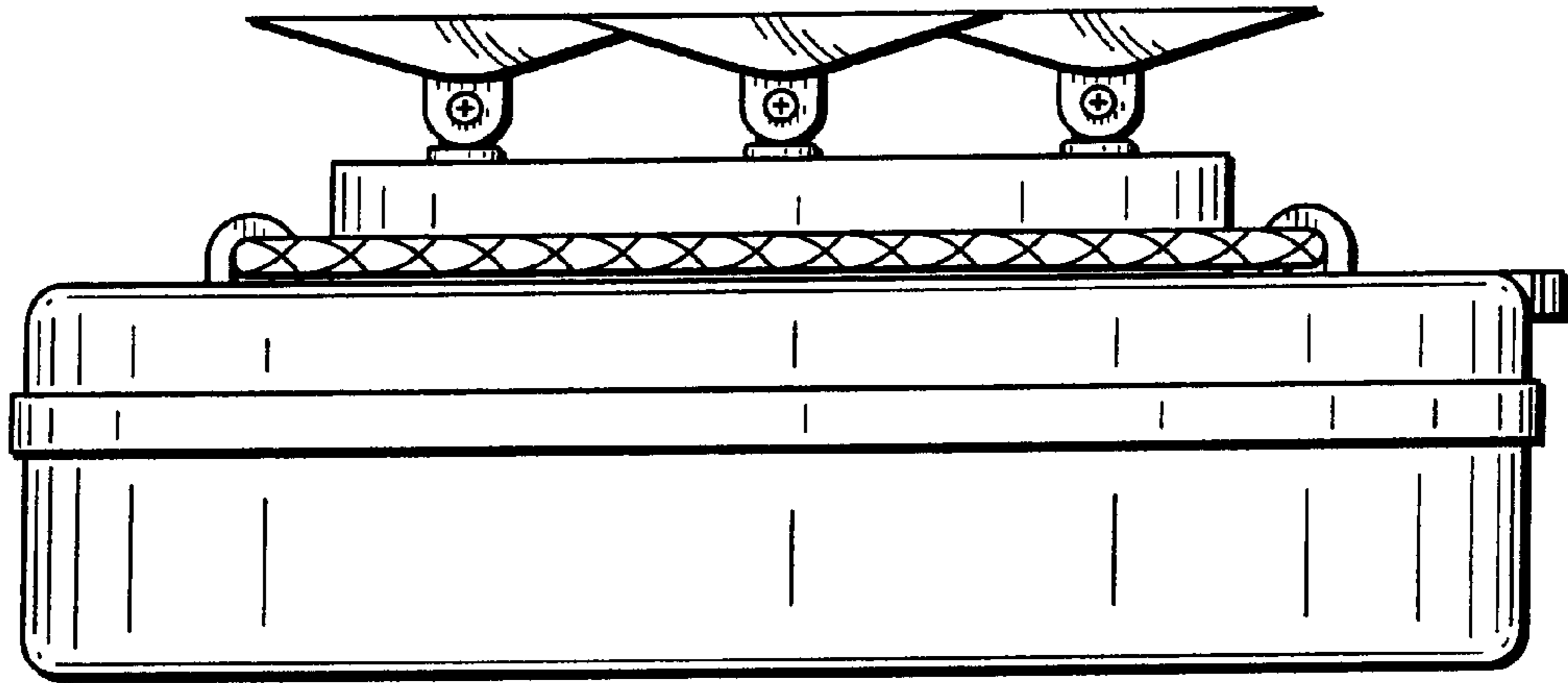

FIG. 7

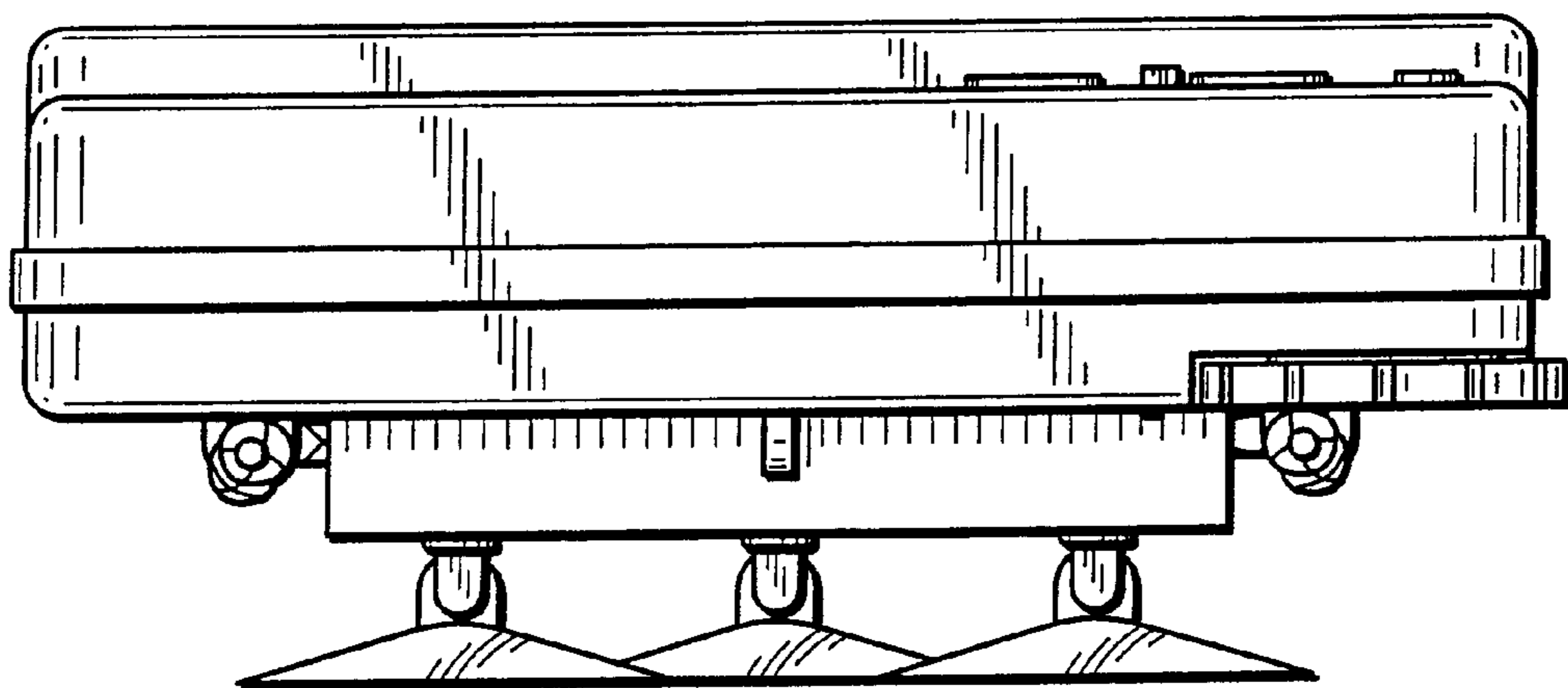

FIG. 8

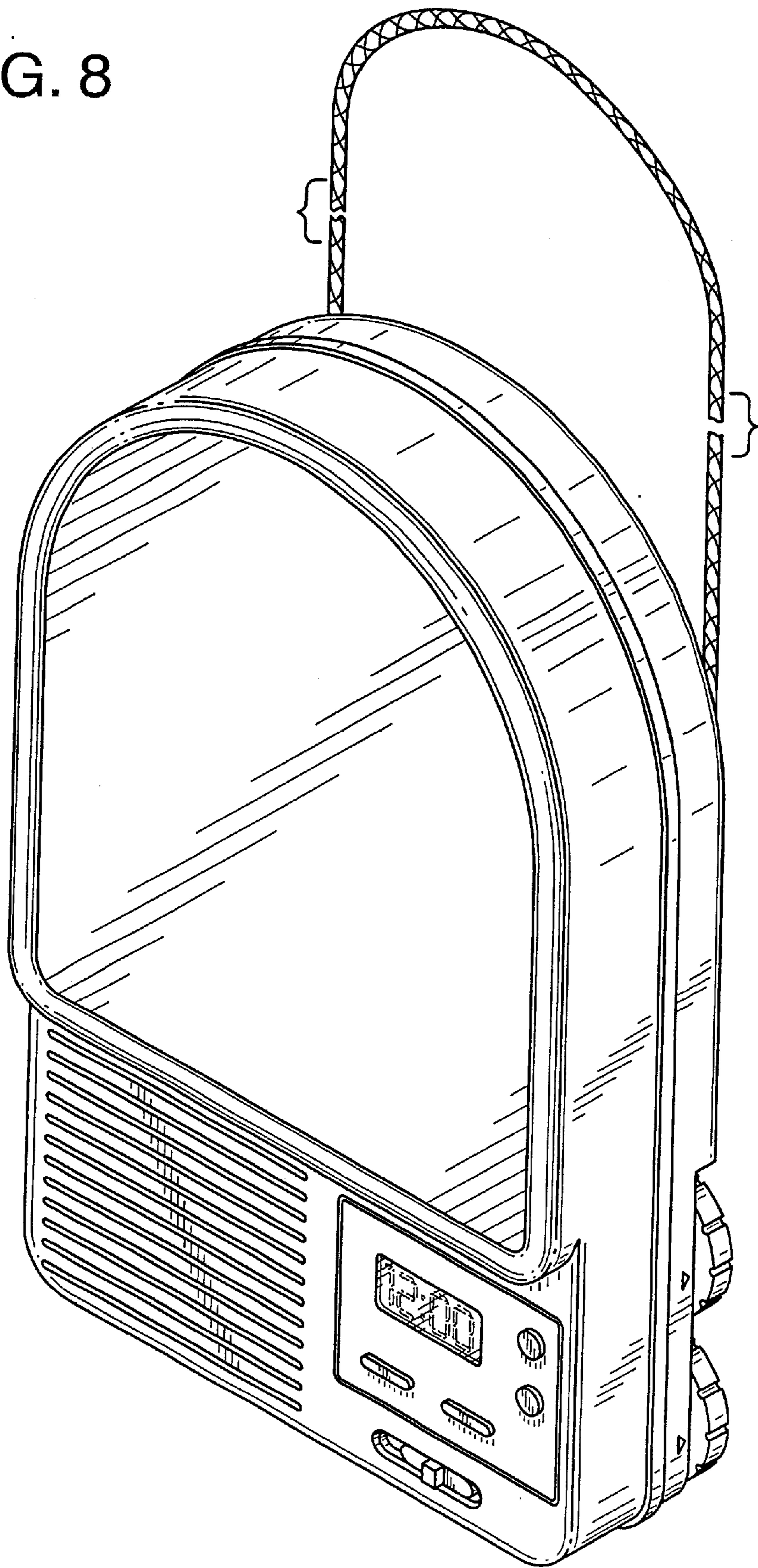

FIG. 9

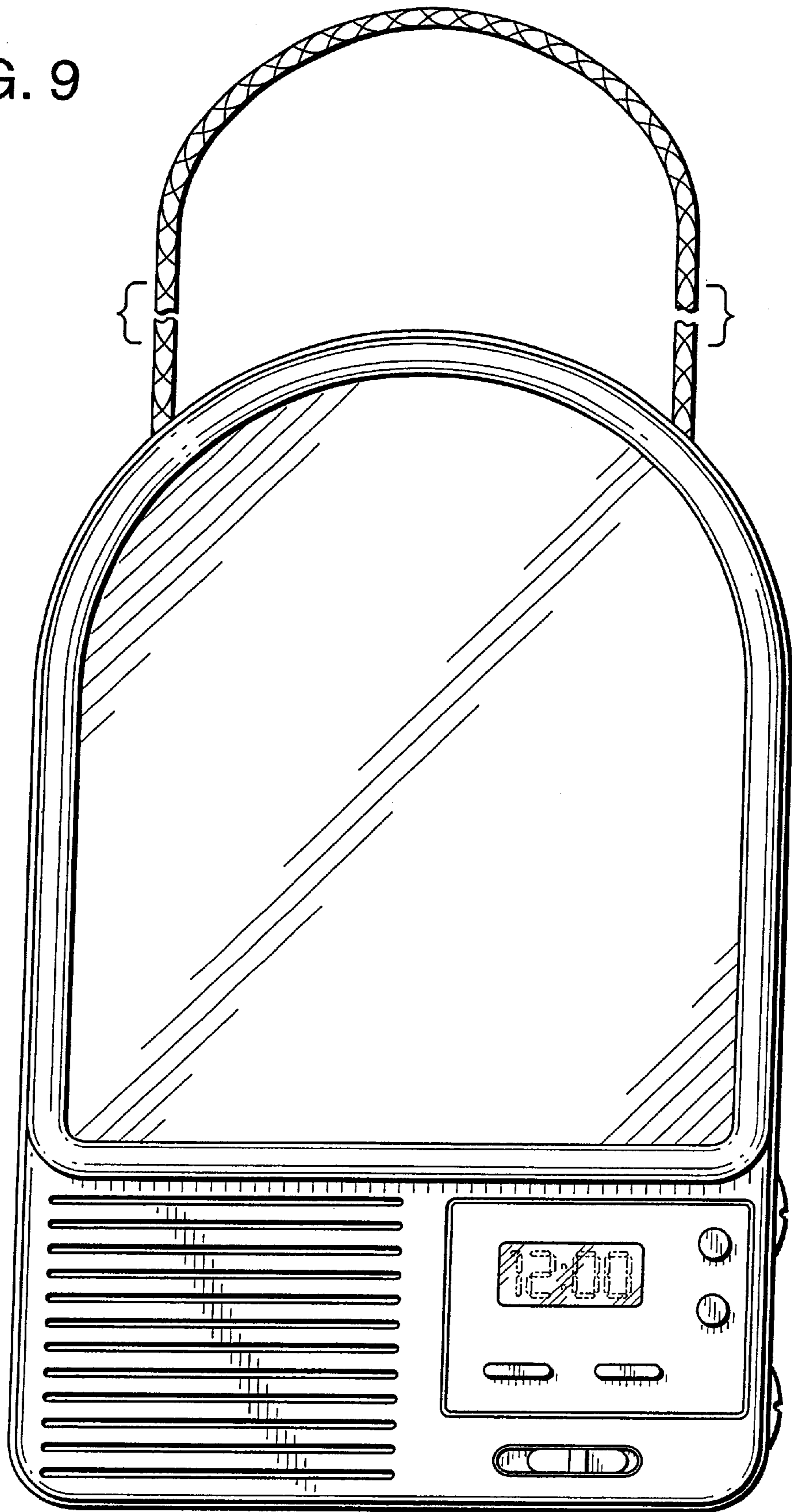

FIG. 10

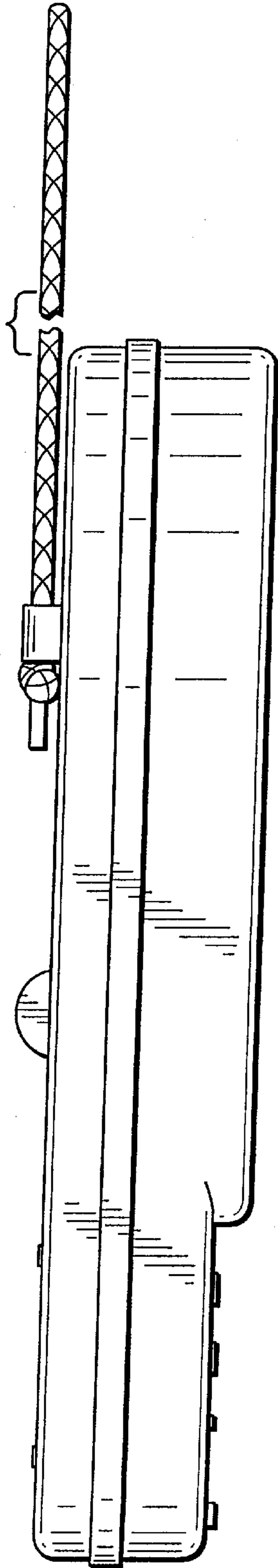

FIG. 11

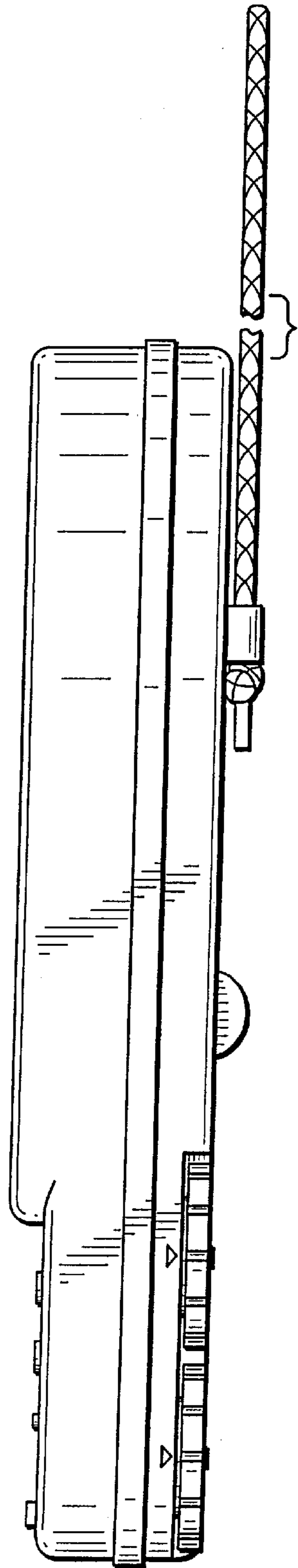

FIG. 12

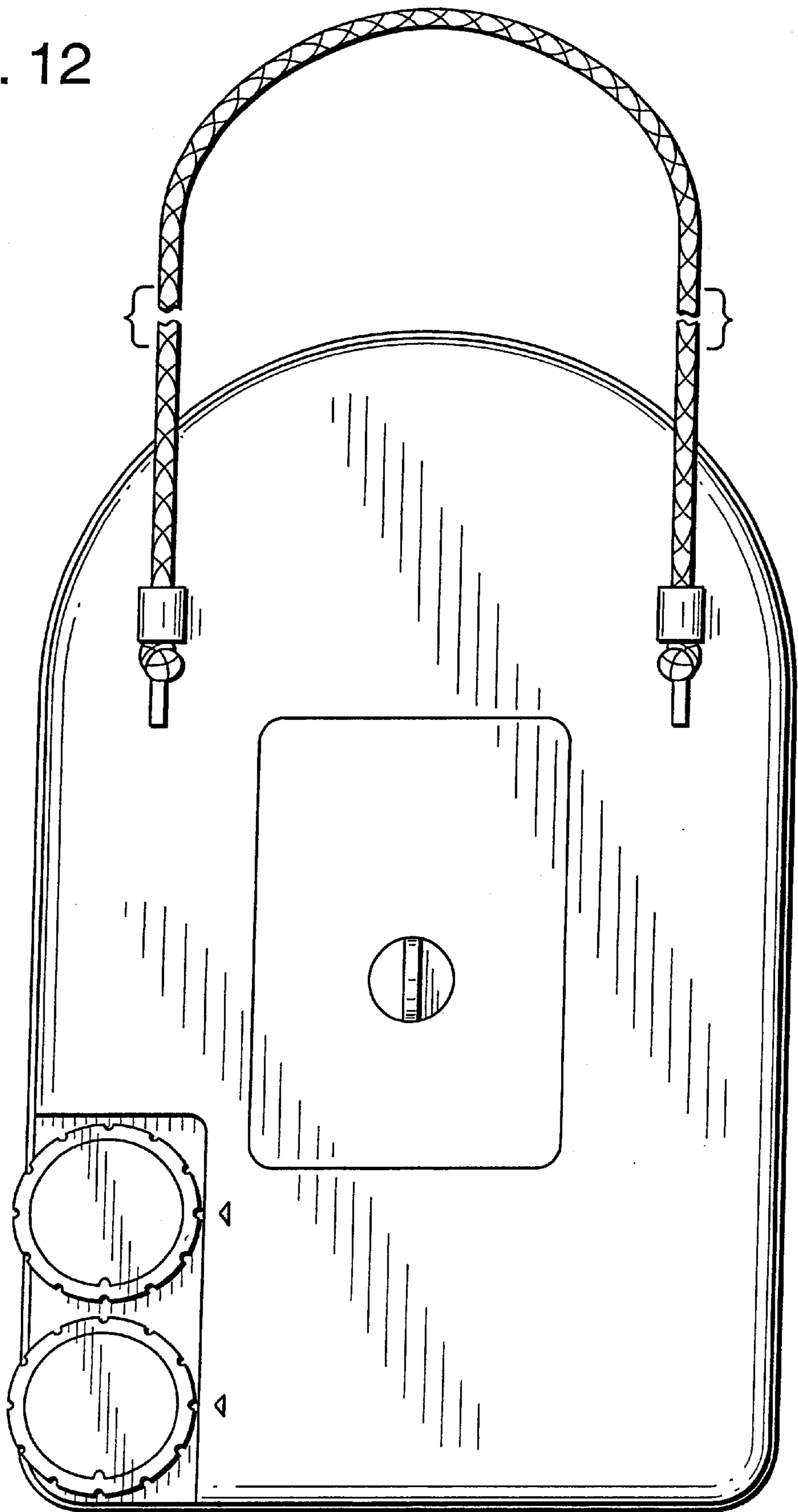

FIG. 13

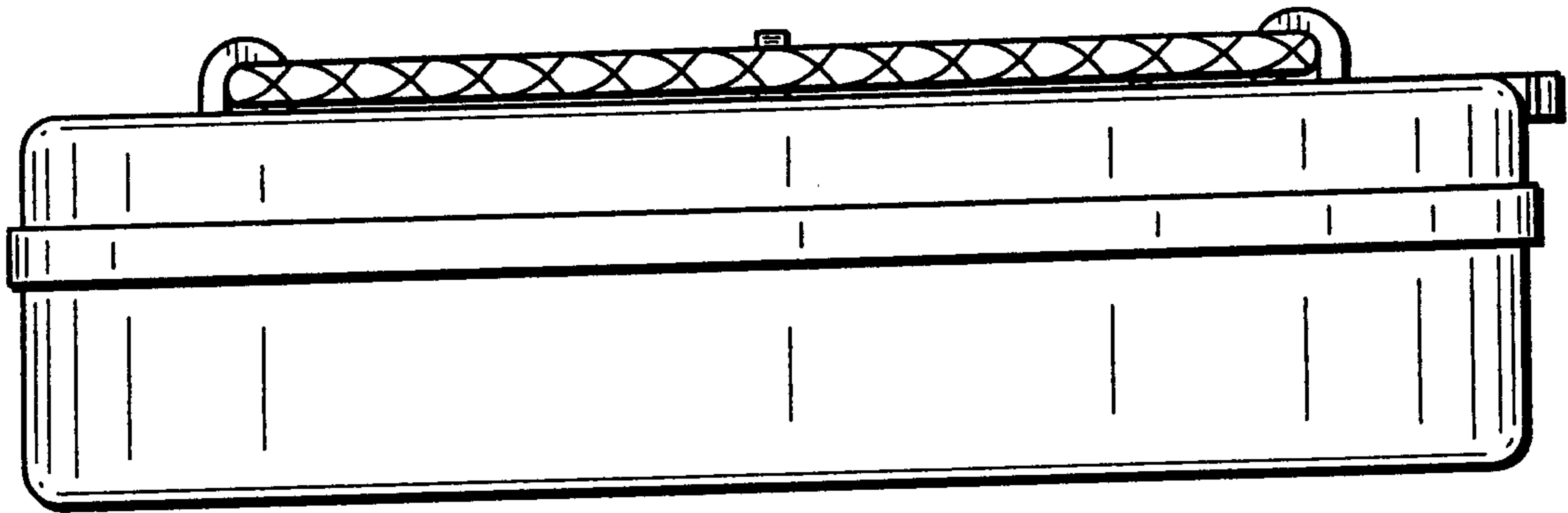

FIG. 14

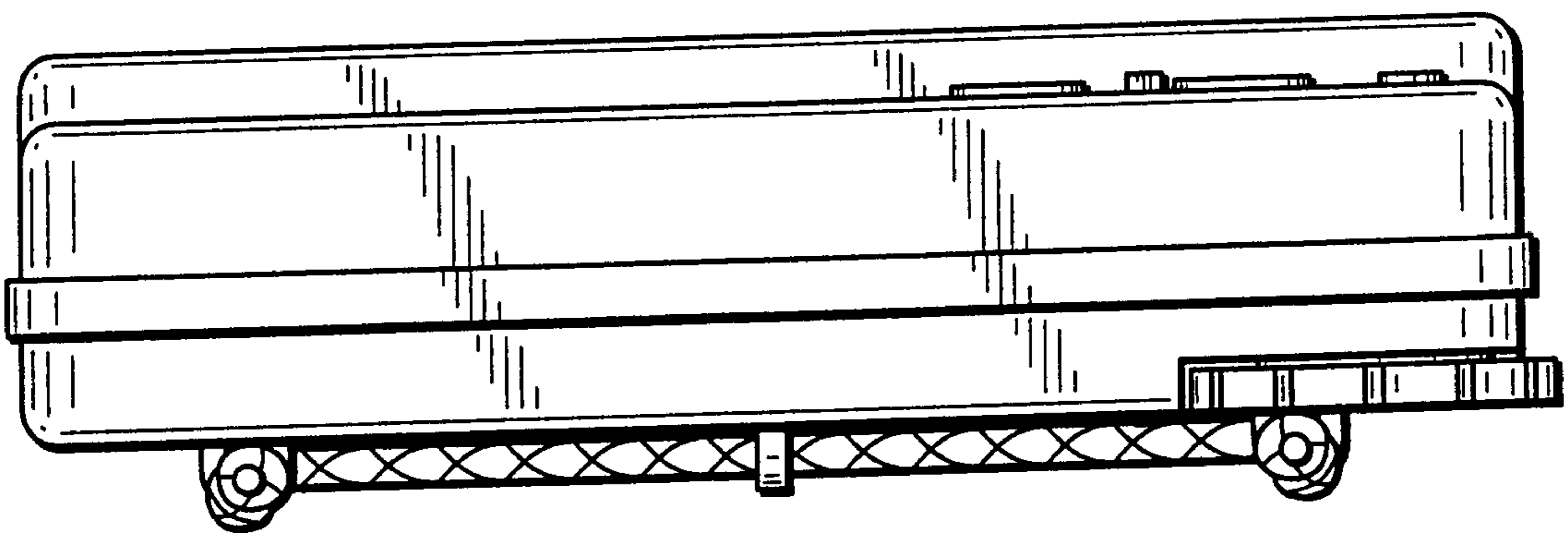

FIG. 15

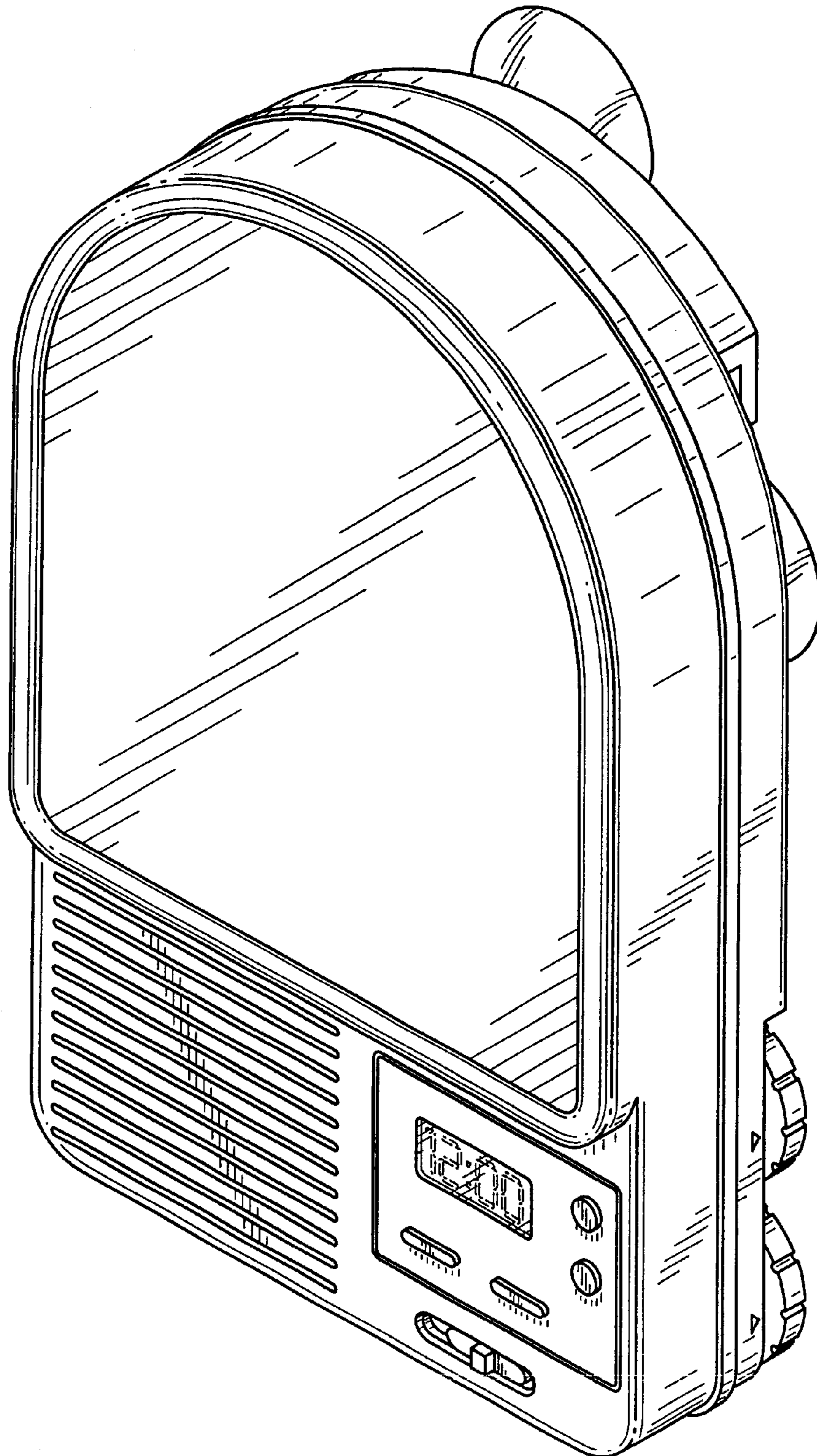

FIG. 16

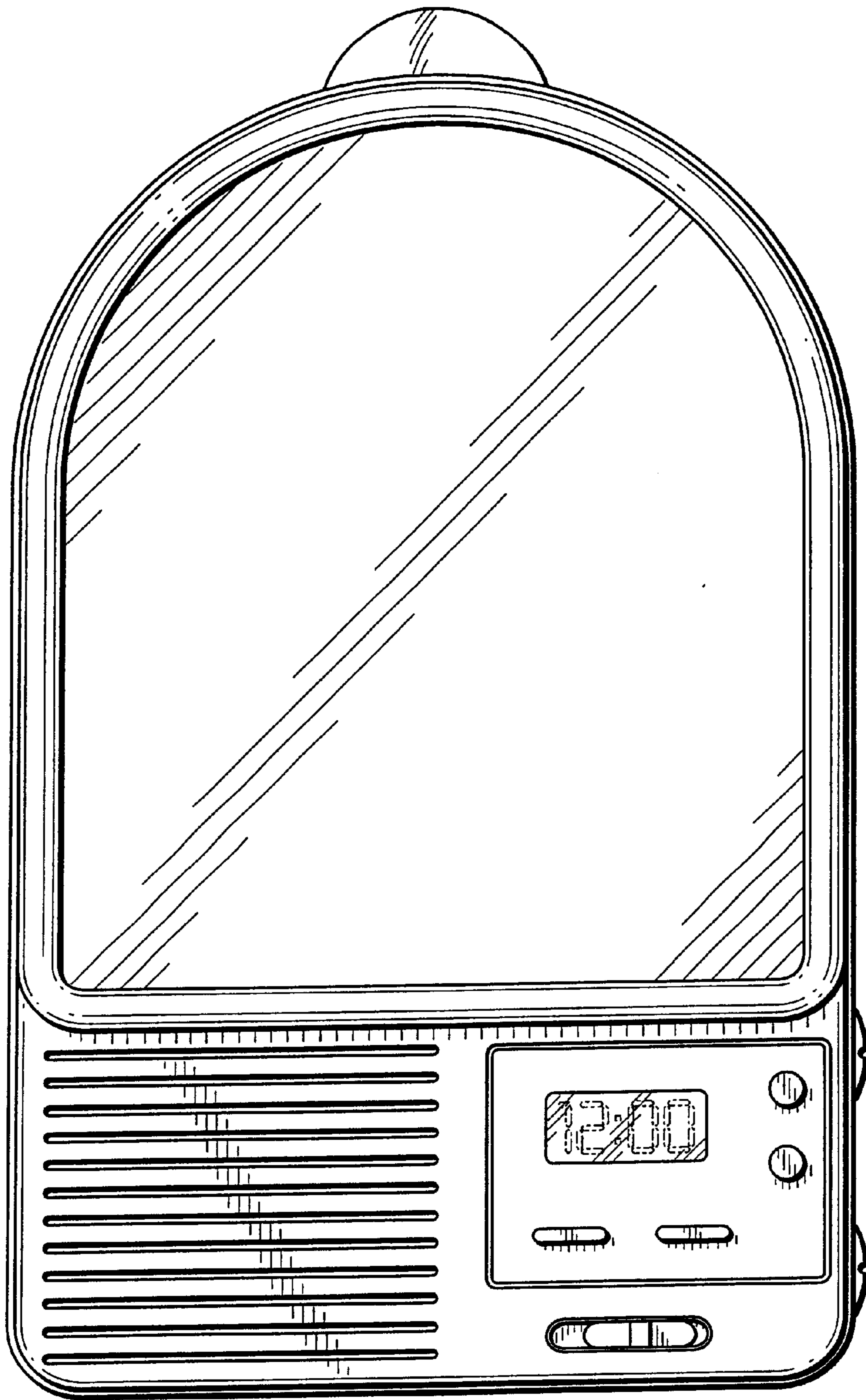

FIG. 17

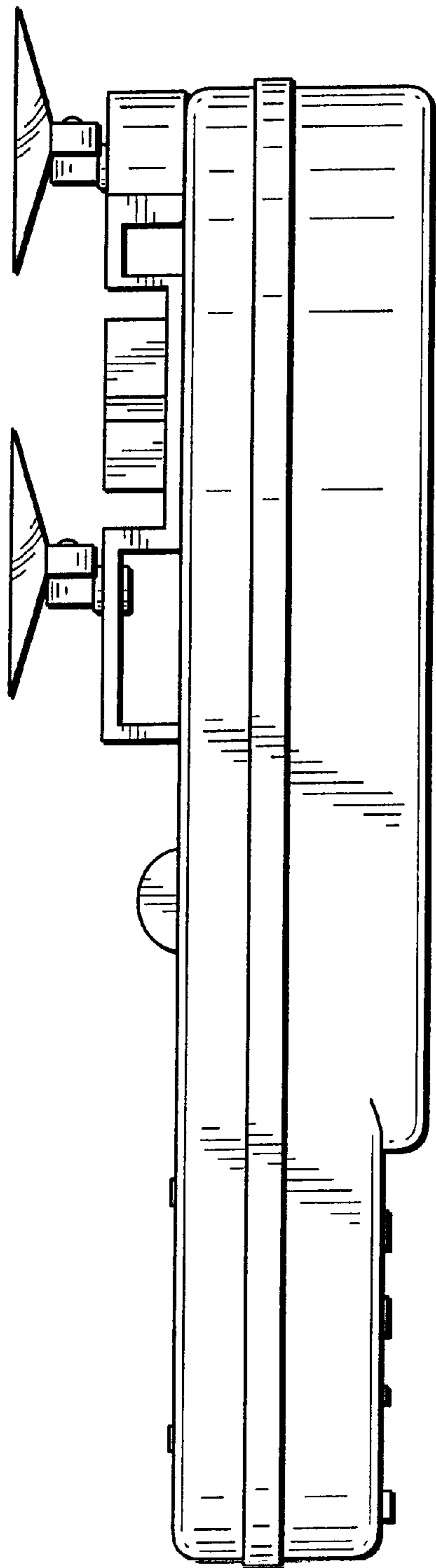

FIG. 18

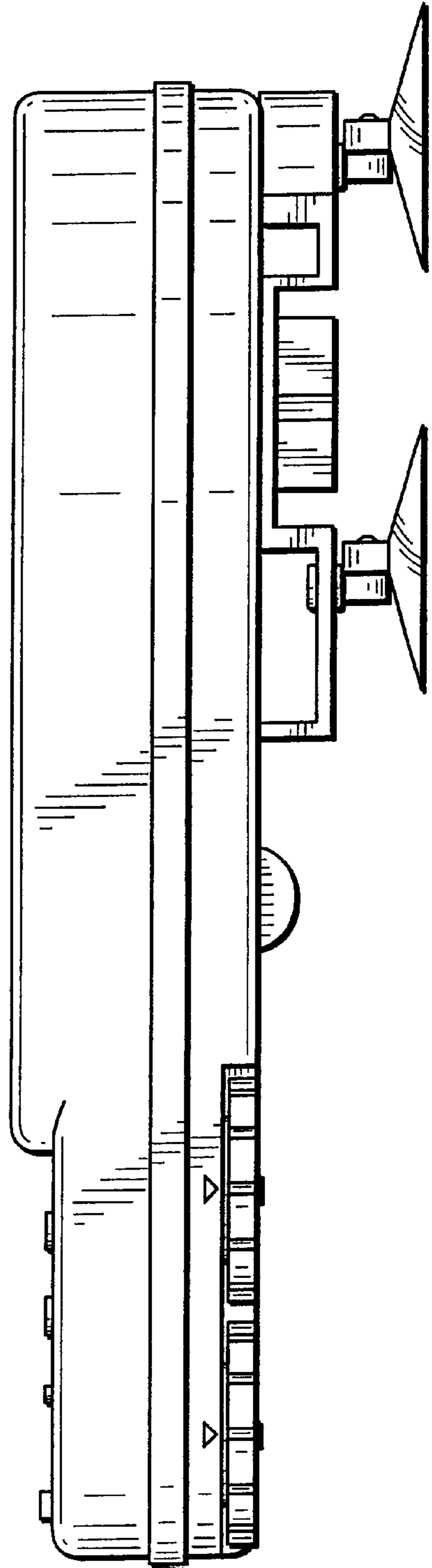

FIG. 19

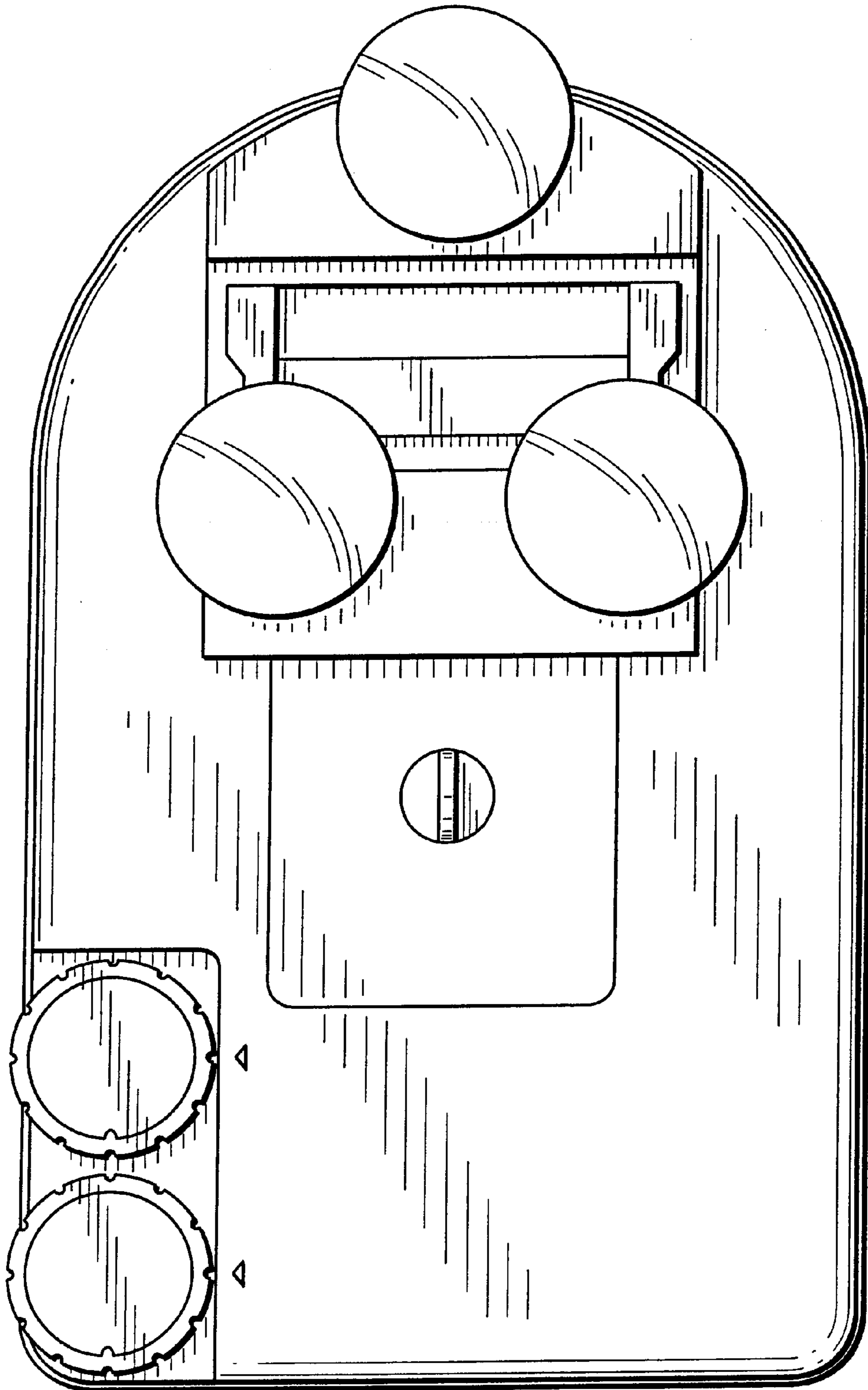

FIG. 20

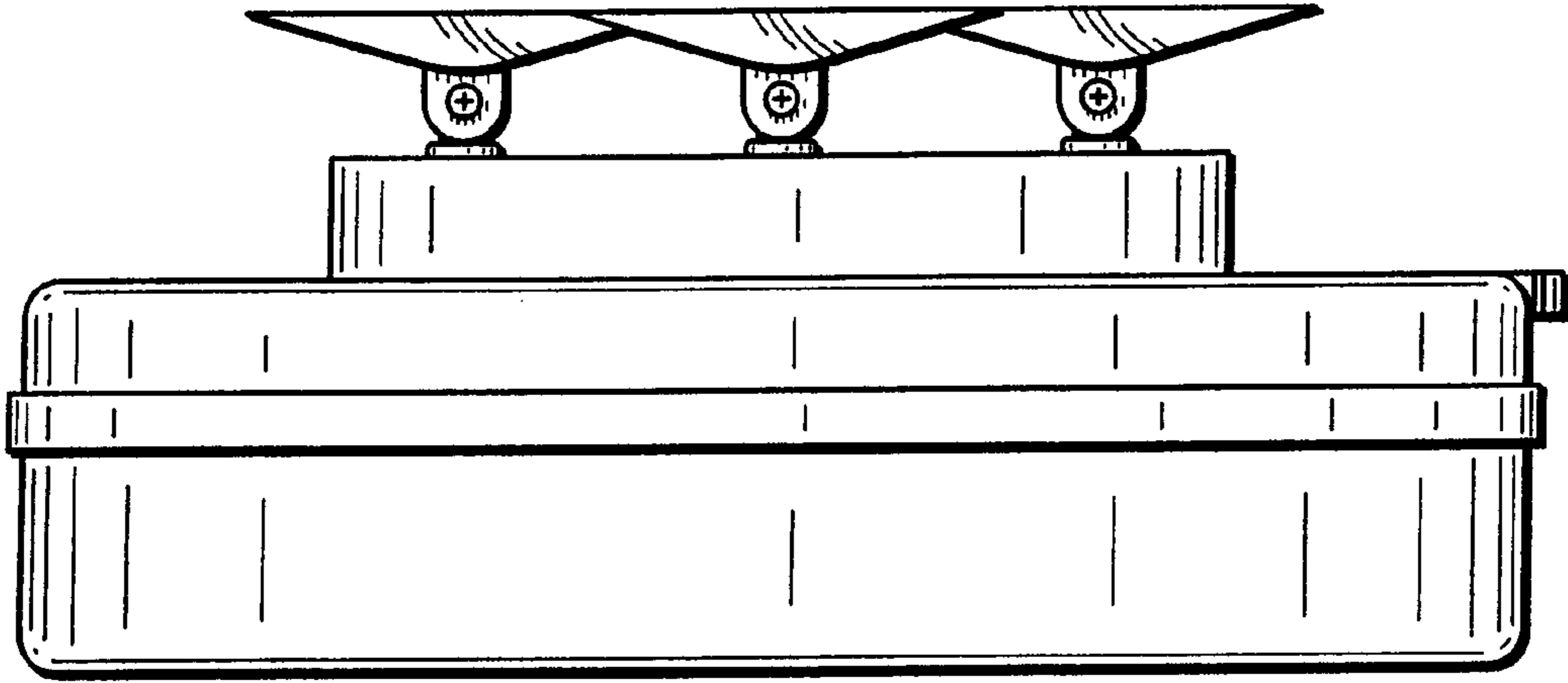

FIG. 21

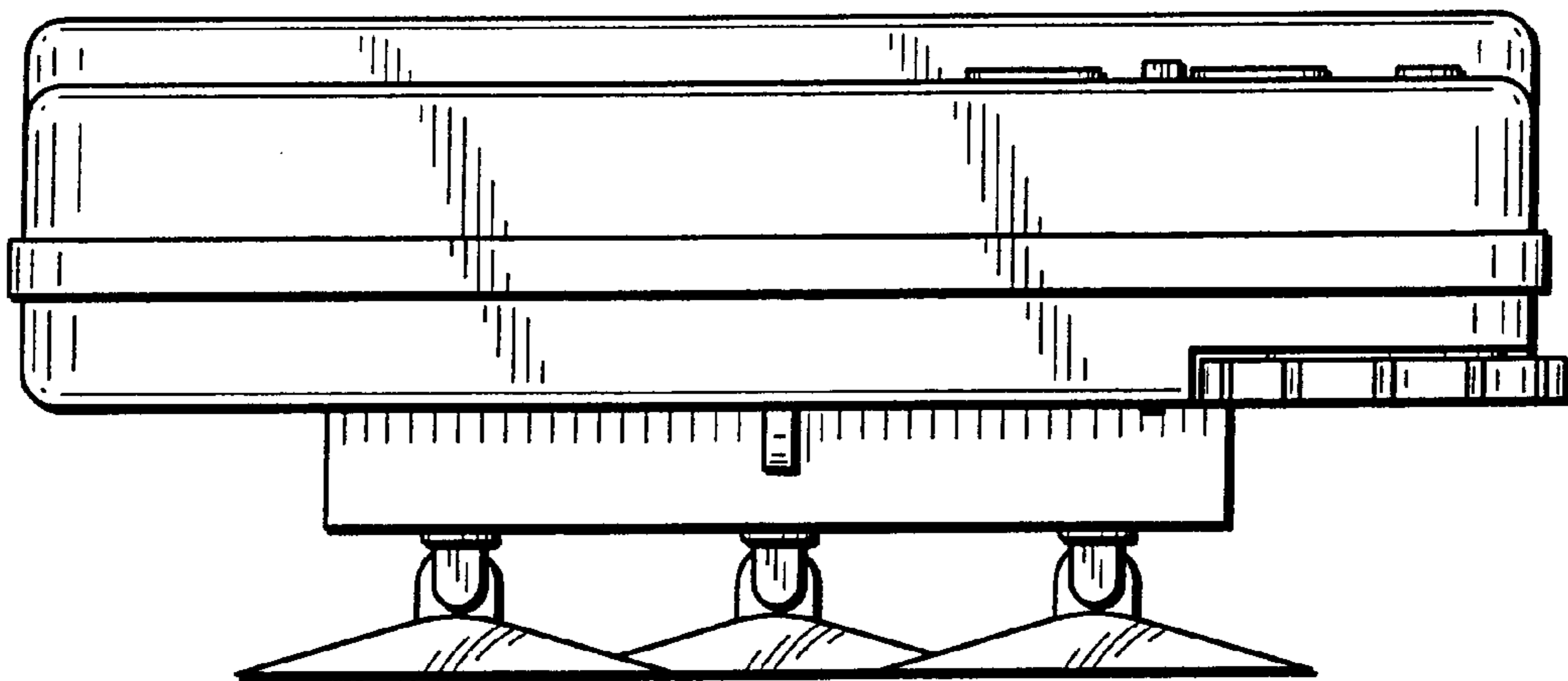

FIG. 22

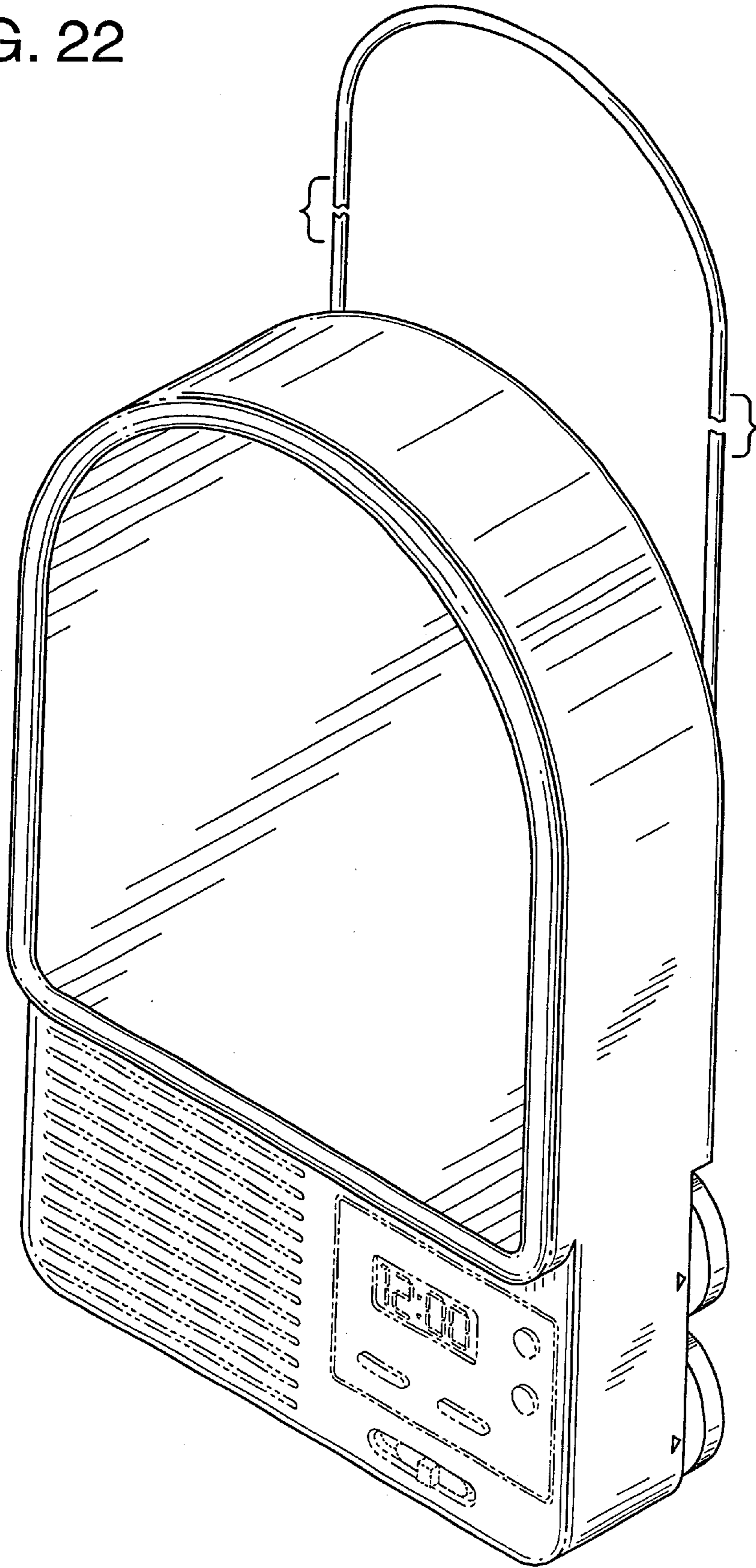

FIG. 23

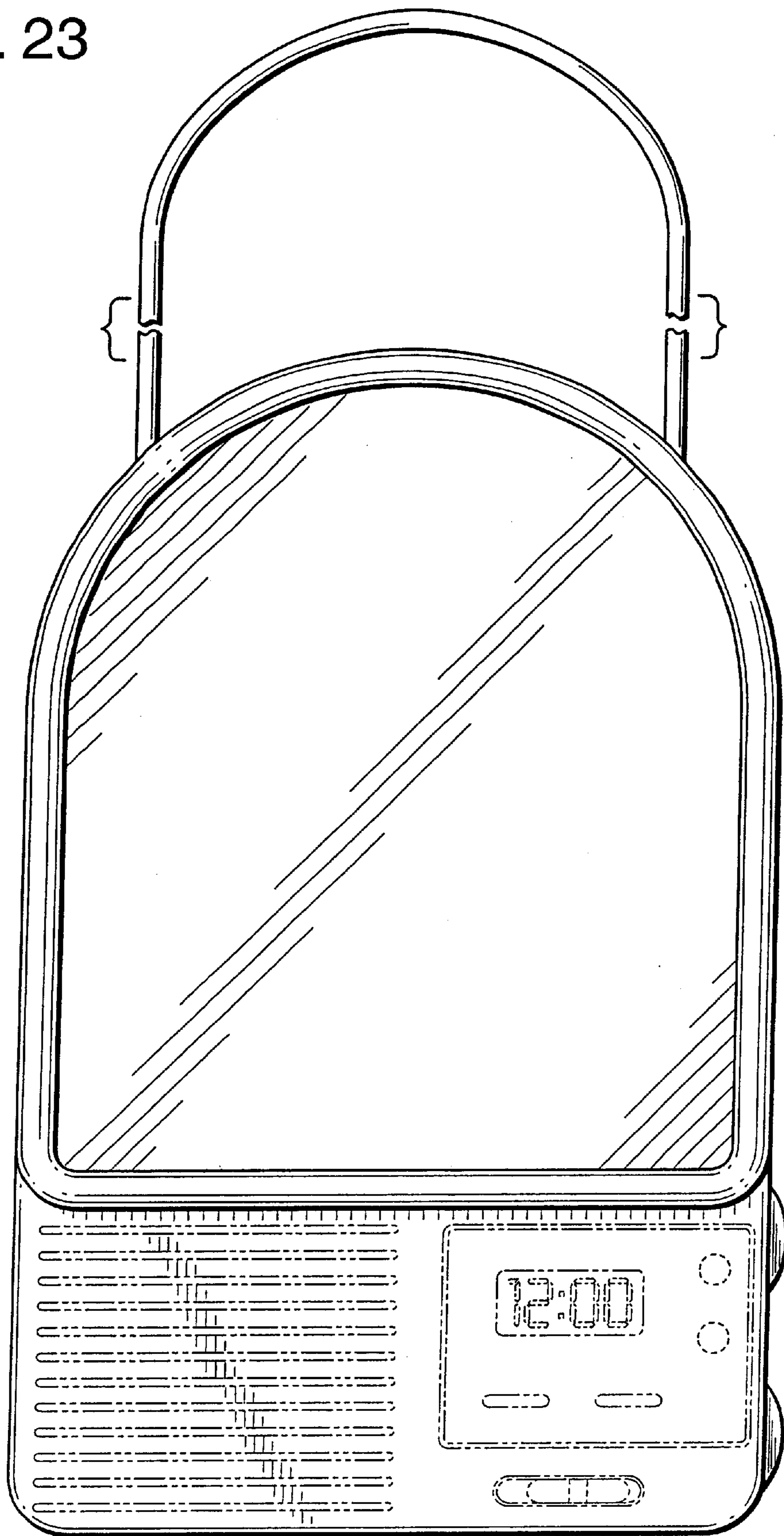

FIG. 24

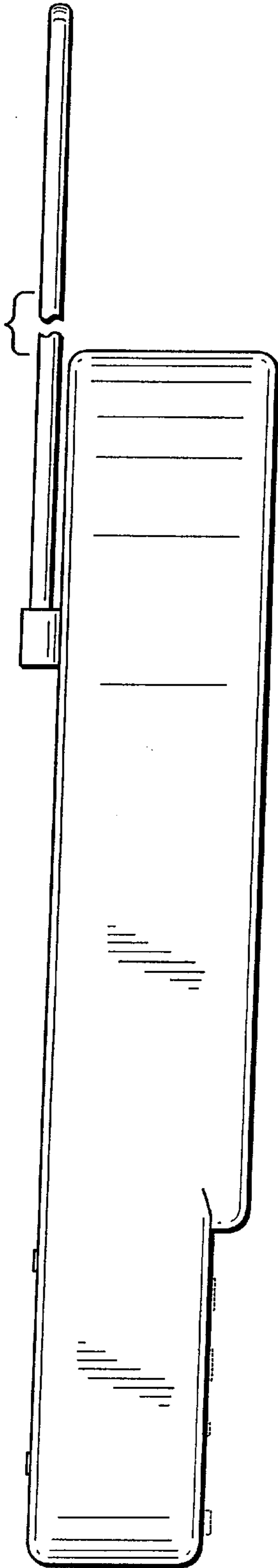

FIG. 25

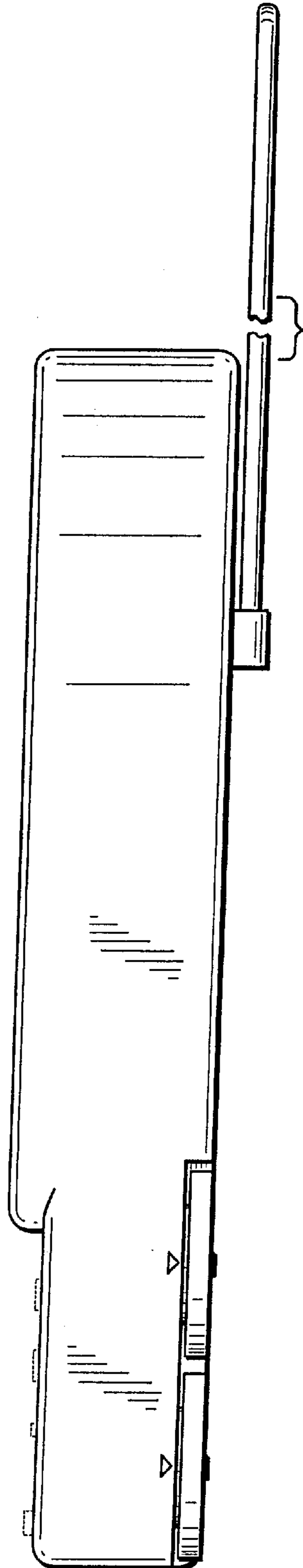

FIG. 26

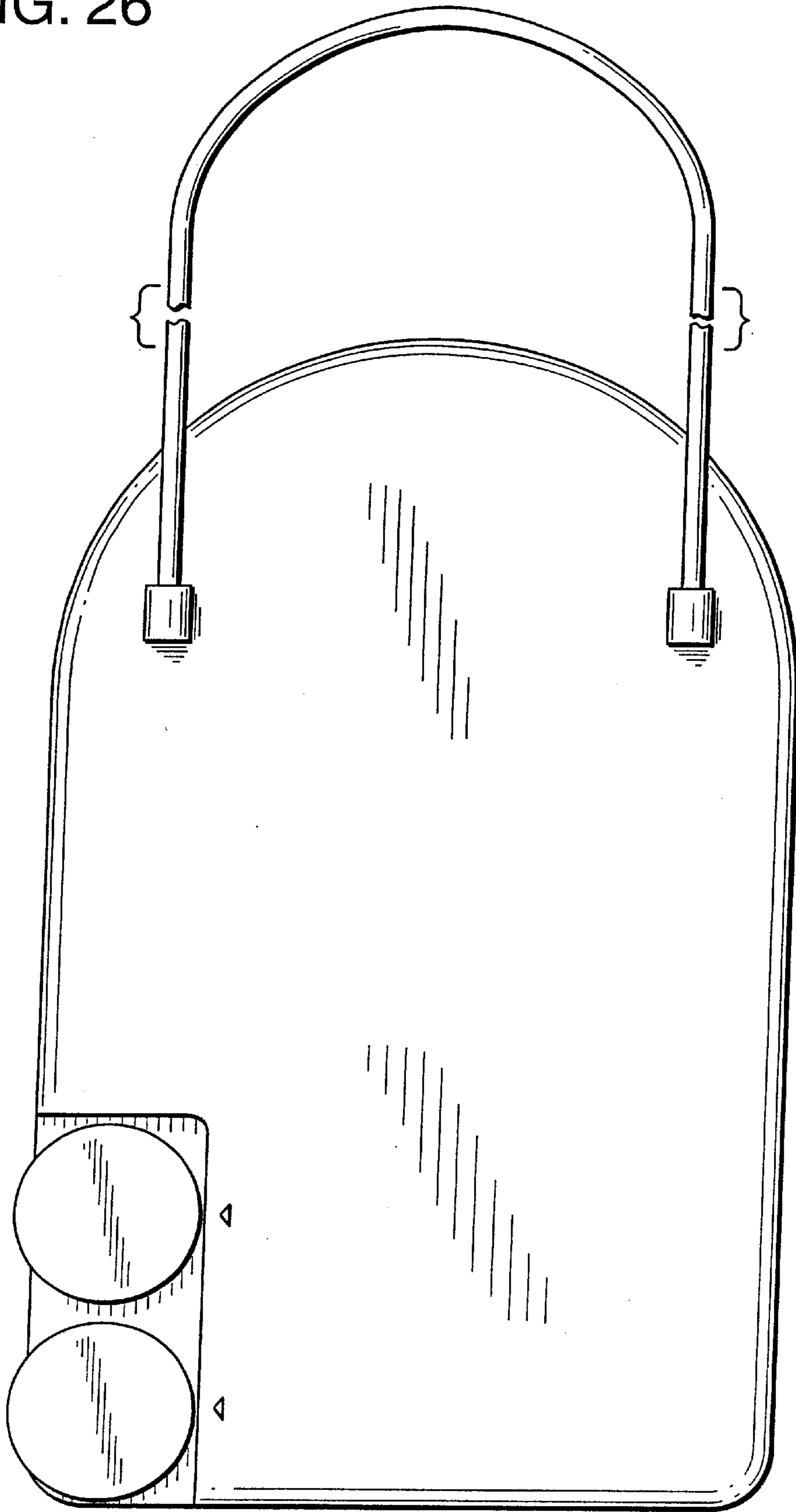

FIG. 27

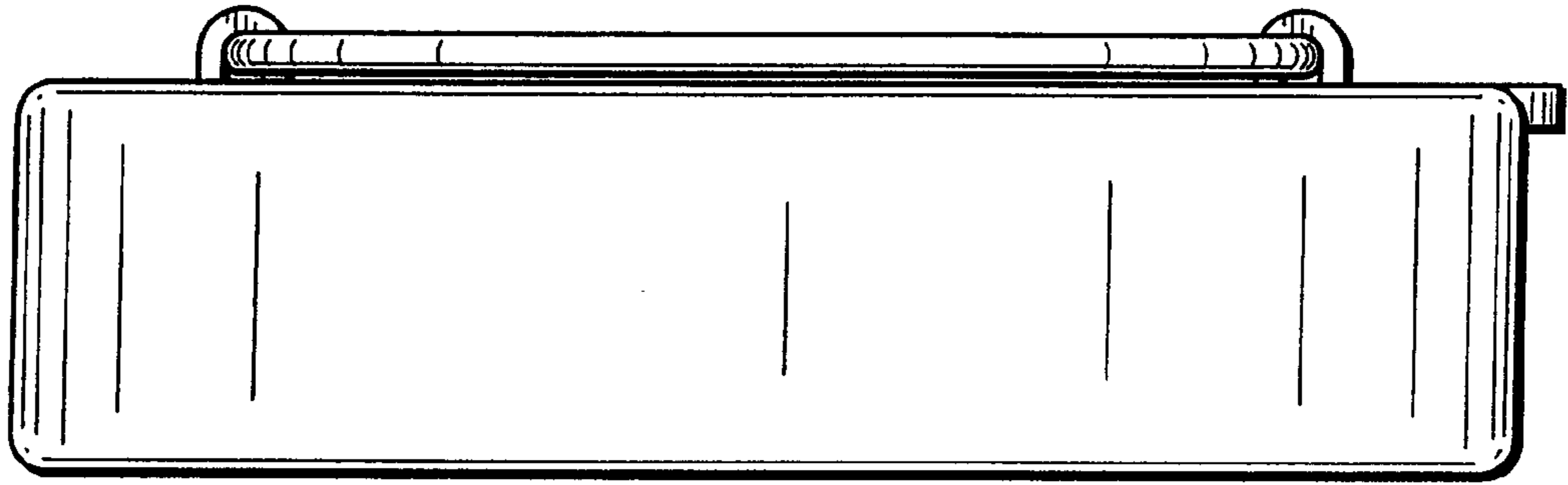

FIG. 28

