



US00D477177S

(12) **United States Design Patent**
Jeong

(10) **Patent No.:** **US D477,177 S**

(45) **Date of Patent:** **** Jul. 15, 2003**

(54) **GAS OVEN RANGE**

(75) Inventor: **Sang Moon Jeong**, Seoul (KR)

(73) Assignee: **LG Electronics Inc.**, Seoul (KR)

(**) Term: **14 Years**

(21) Appl. No.: **29/160,624**

(22) Filed: **May 15, 2002**

(30) **Foreign Application Priority Data**

Nov. 20, 2001 (KR) 2001-32529

(51) **LOC (7) Cl.** **07-02**

(52) **U.S. Cl.** **D7/340**

(58) **Field of Search** D7/340, 323, 339-341,
D7/346-348; 126/39 B, 211, 214 R, 39 C,
39 R; 219/391, 392

(56) **References Cited**

U.S. PATENT DOCUMENTS

- D172,209 S * 5/1954 Armstrong D7/340
- 3,402,281 A * 9/1968 Vonderhaar 219/391
- D336,210 S * 6/1993 Birtwisle D7/340
- D349,004 S * 7/1994 Ivanovich D7/340

- D364,529 S * 11/1995 Wilsdorf D7/340
- D375,867 S * 11/1996 Sparks D7/340

* cited by examiner

Primary Examiner—Catherine R. Oliver

(74) *Attorney, Agent, or Firm*—Birch, Stewart, Kolasch & Birch, LLP

(57) **CLAIM**

I, claim the ornamental design for <gas oven range>, as shown and described.

DESCRIPTION

FIG. 1 is a perspective view of <gas oven range> showing the new design:

FIG. 2 is a front view thereof;

FIG. 3 is a rear view thereof;

FIG. 4 is a left-side view thereof;

FIG. 5 is a right-side view thereof;

FIG. 6 is a top plan view thereof;

FIG. 7 is a bottom plan view thereof;

FIG. 8 is reference view 1 representing this article with open-door; and,

FIG. 9 is a reference view 2 representing this article with open-door.

1 Claim, 6 Drawing Sheets

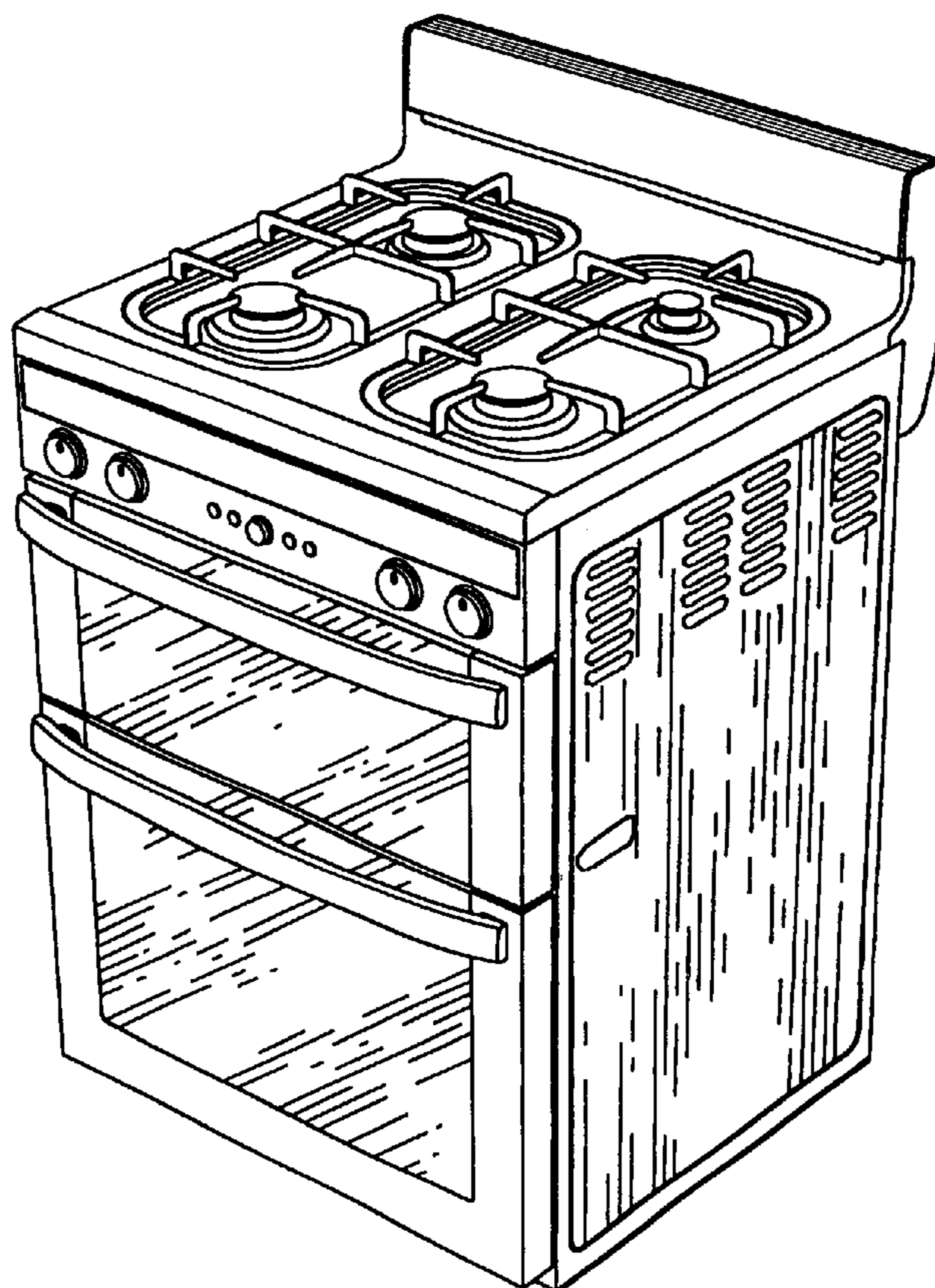

FIG. 1

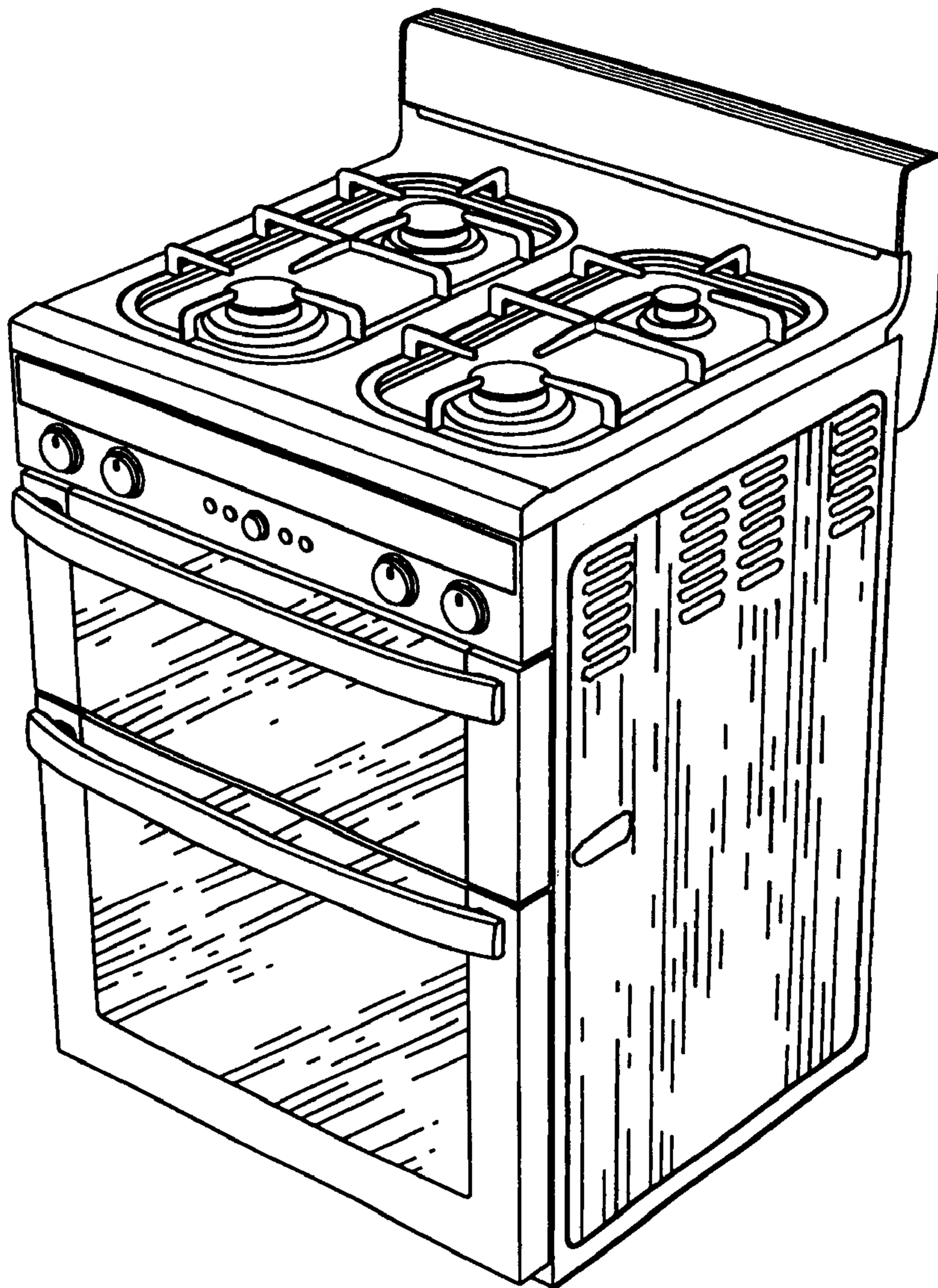

FIG. 2

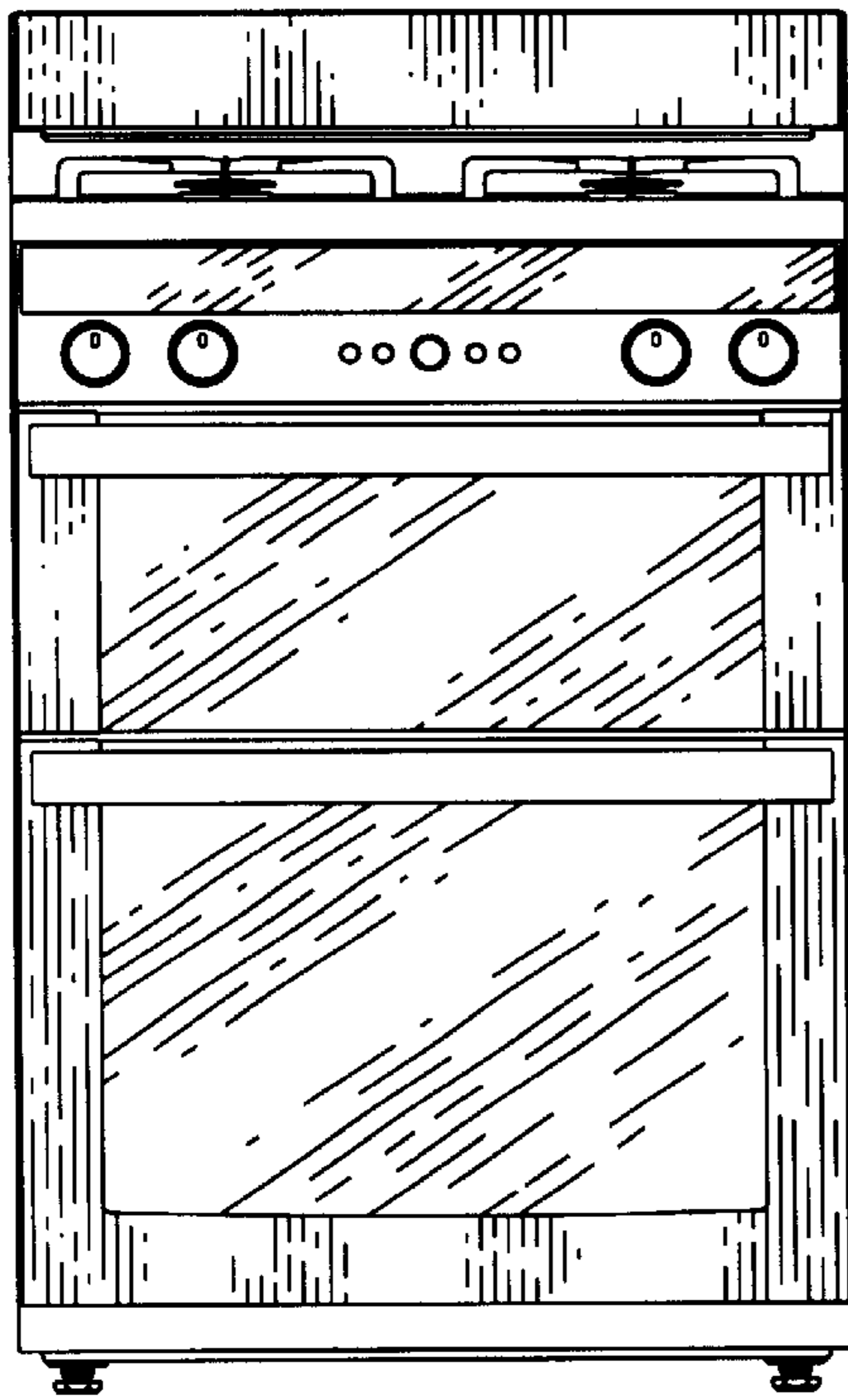

FIG. 3

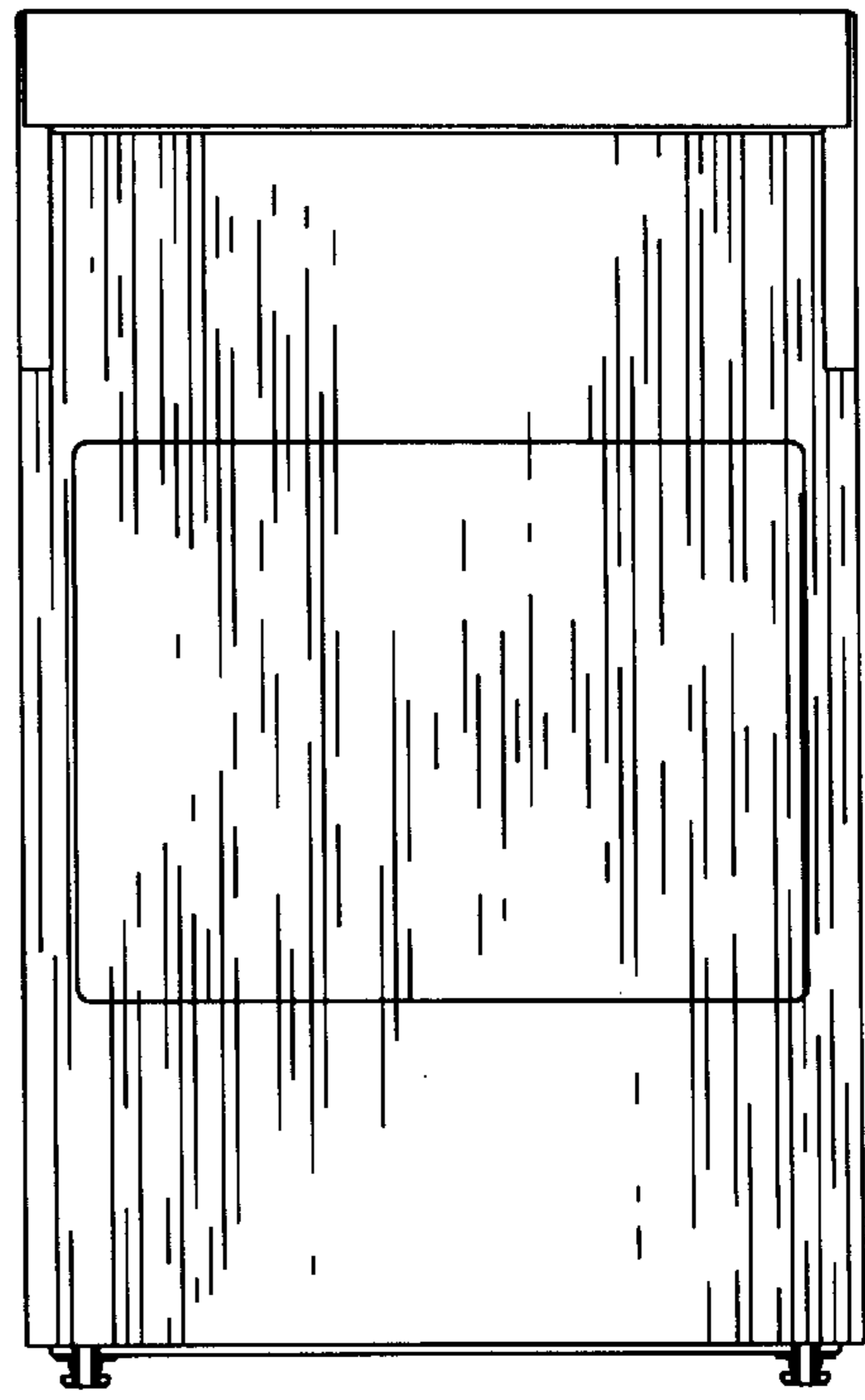

FIG. 4

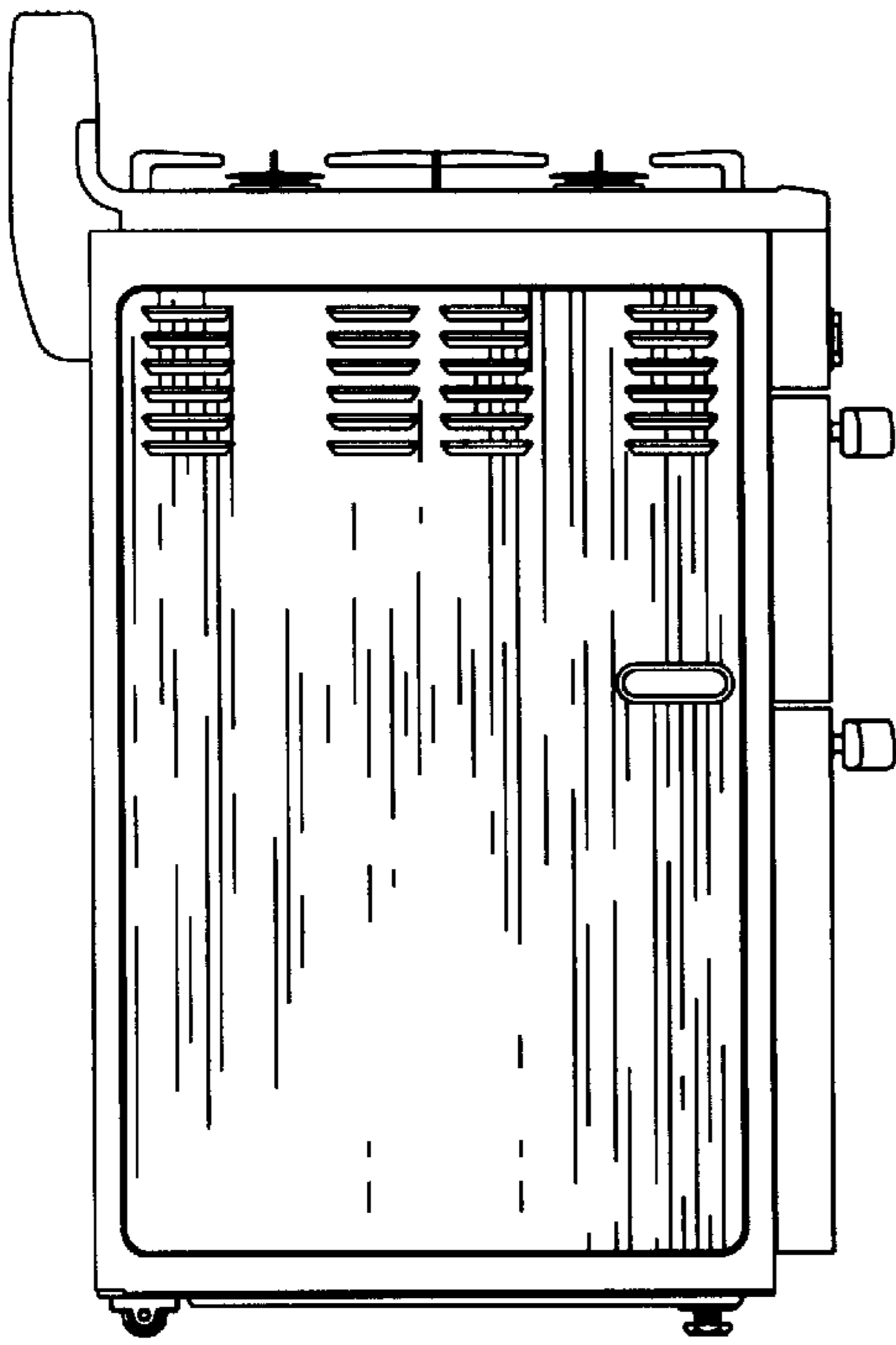

FIG. 5

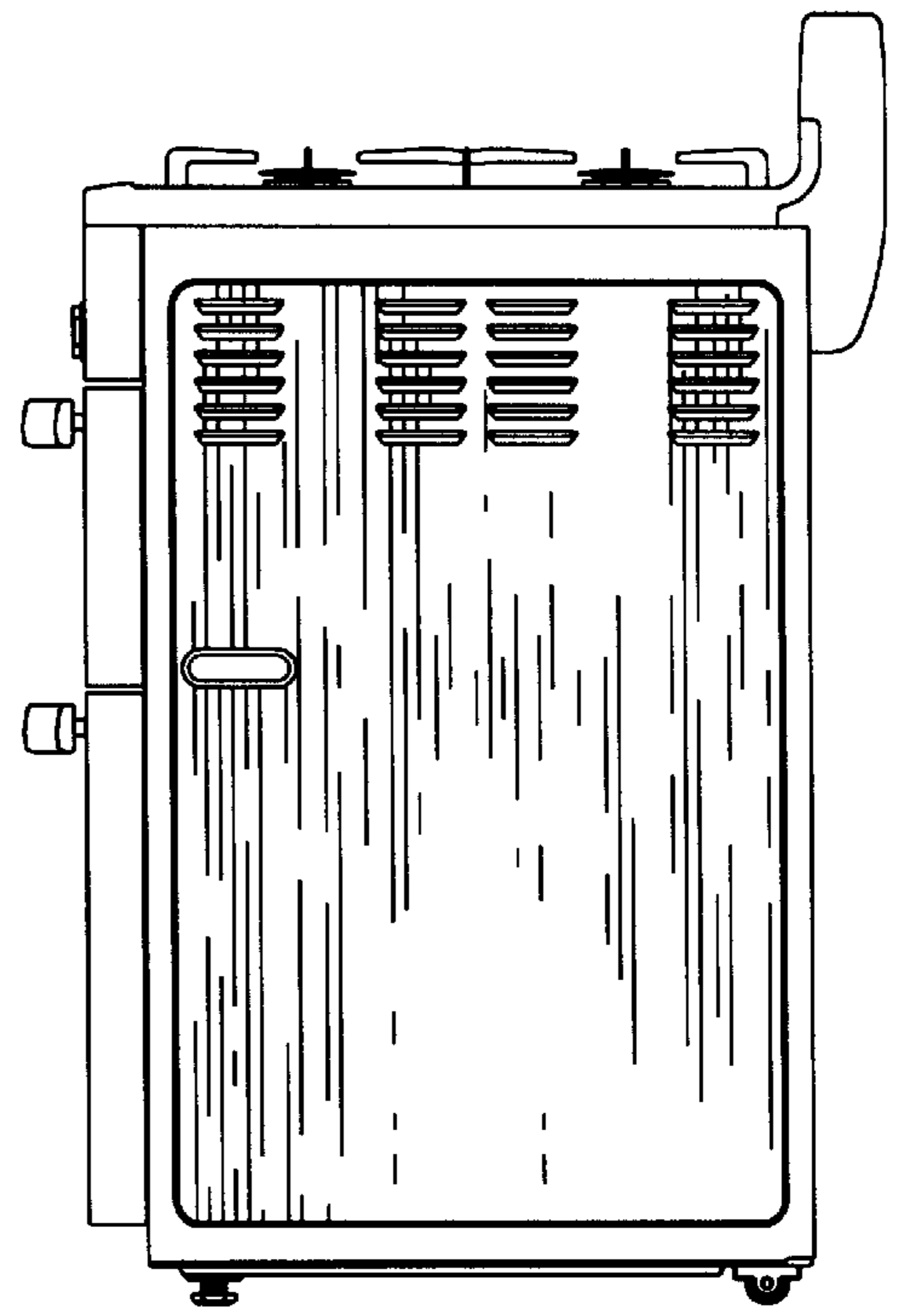

FIG. 6

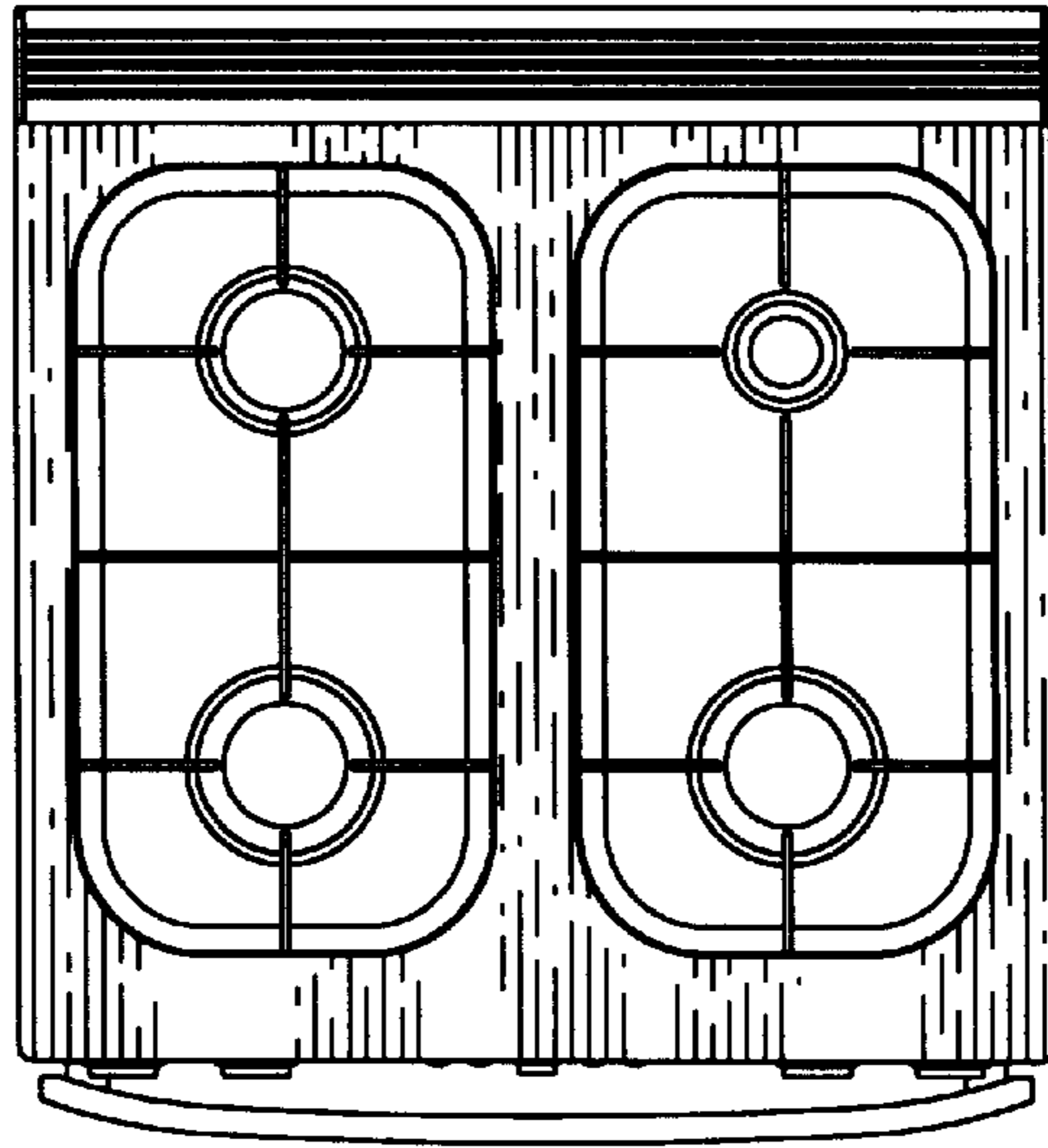

FIG. 7

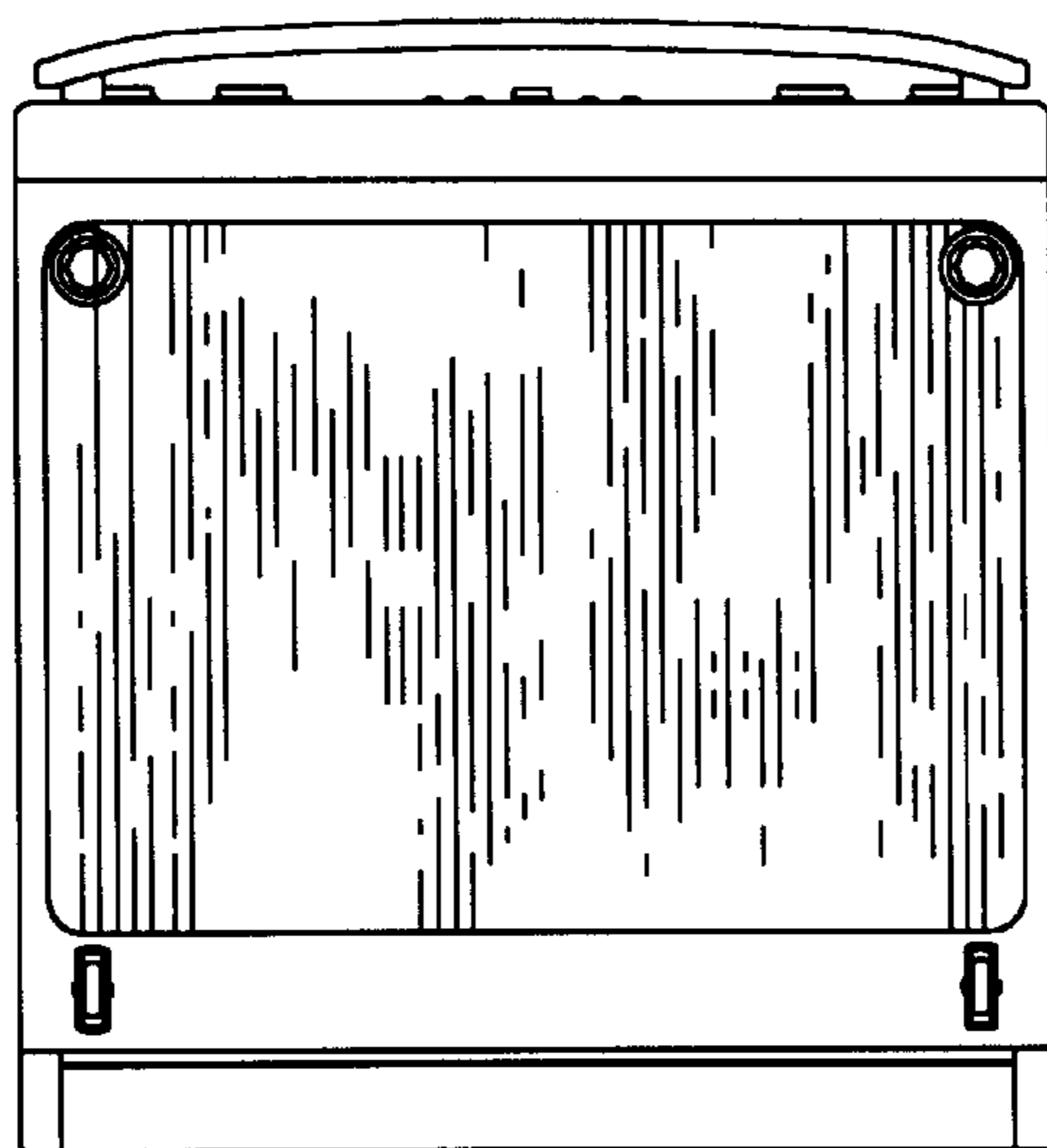

FIG. 8

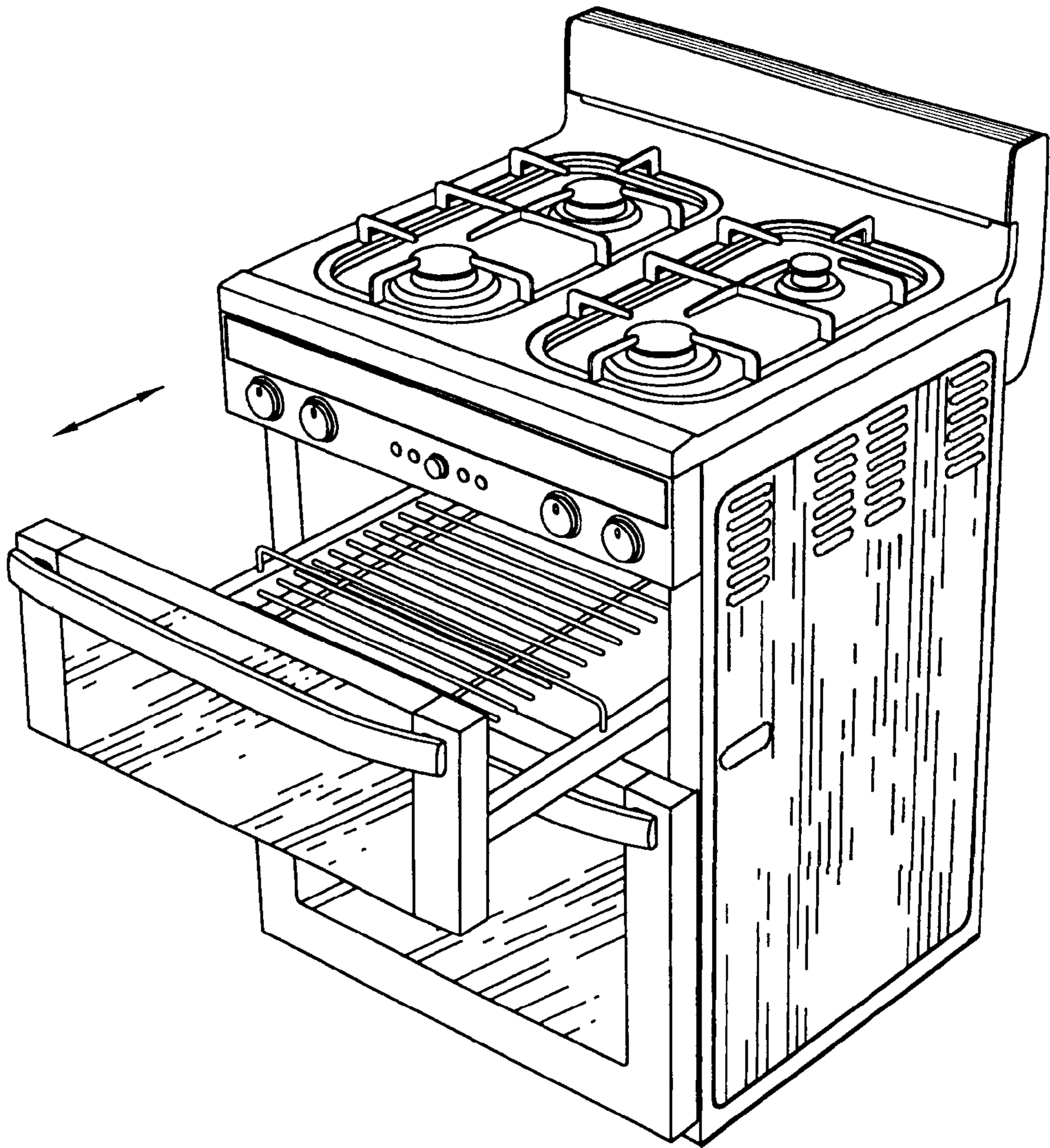

FIG. 9

